



LIBRARIES

UNIVERSITY OF WISCONSIN-MADISON

Geomorphology illustrations. [between 1950 and 1955?]

Thwaites, F. T. (Fredrik Turville), 1883-1961
[s.l.]: [s.n.], [between 1950 and 1955?]

<https://digital.library.wisc.edu/1711.dl/4QKKQNPRSMX528L>

<http://rightsstatements.org/vocab/UND/1.0/>

For information on re-use see:

<http://digital.library.wisc.edu/1711.dl/Copyright>

The libraries provide public access to a wide range of material, including online exhibits, digitized collections, archival finding aids, our catalog, online articles, and a growing range of materials in many media.

When possible, we provide rights information in catalog records, finding aids, and other metadata that accompanies collections or items. However, it is always the user's obligation to evaluate copyright and rights issues in light of their own use.

scale 1" = 1000'

chert	110	make	22	320	15
		at	110:		
shales	60	shale	100		
	130	lime	110	} 340	
	190	shale	130		
		lime	800		
					when 1870

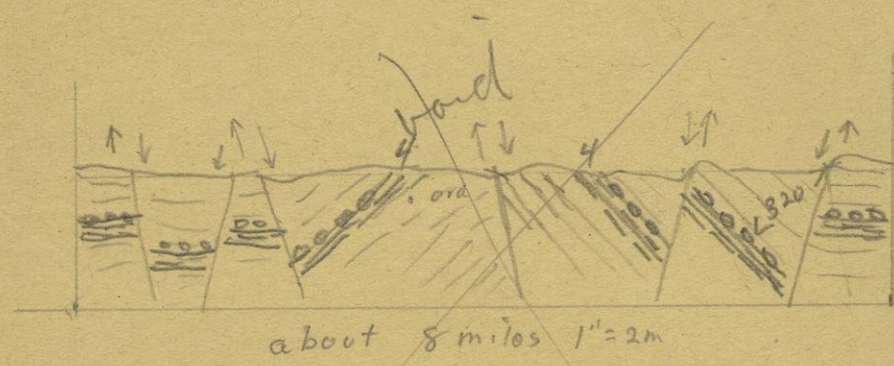

Fig. 39 p27

Cryptovolcanic structure after Bucher generalized



do use this one p27

1" = 2m = 10000' next in line

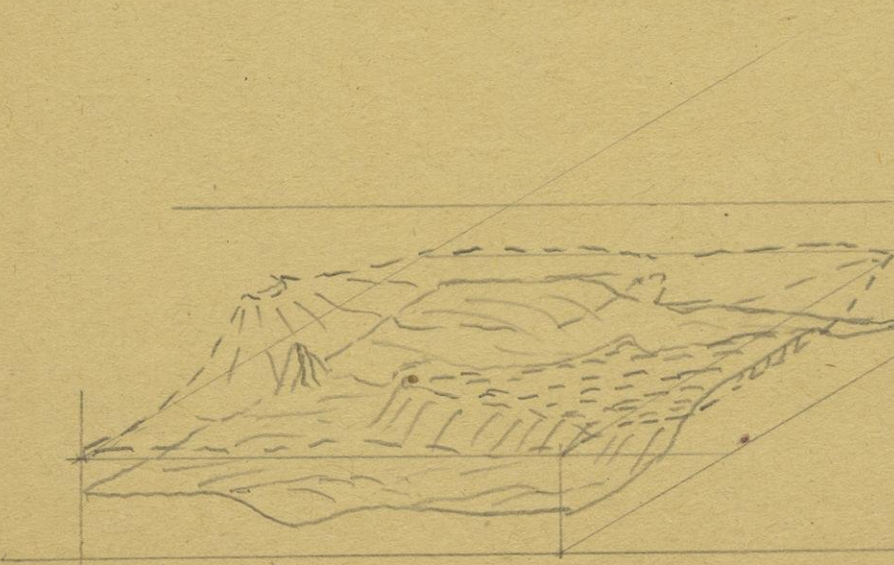
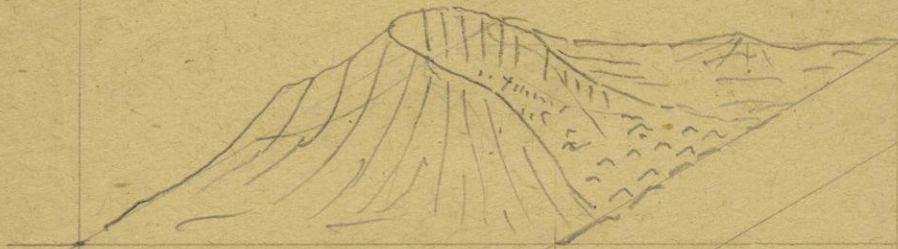

Fig. 40 p27
 Inversion of relief
make 2 p27
 Fig 41 present



p 26

Fig. 34

mud flow from
breaking of crater

Fig 35 western shut
crater L 36 " "
" " 37 " "



p 26

Fig 38

Volcanic neck
& dike ridges

d. 41

- see photo of Ship Rock

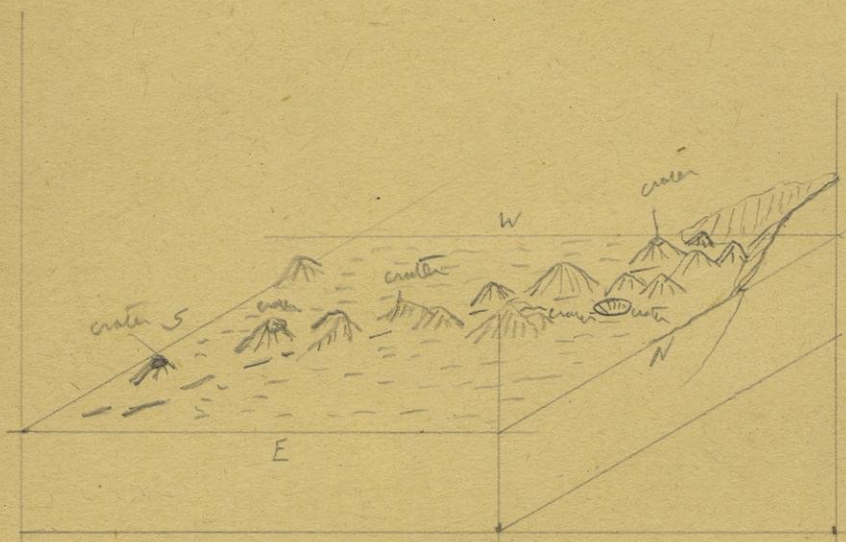
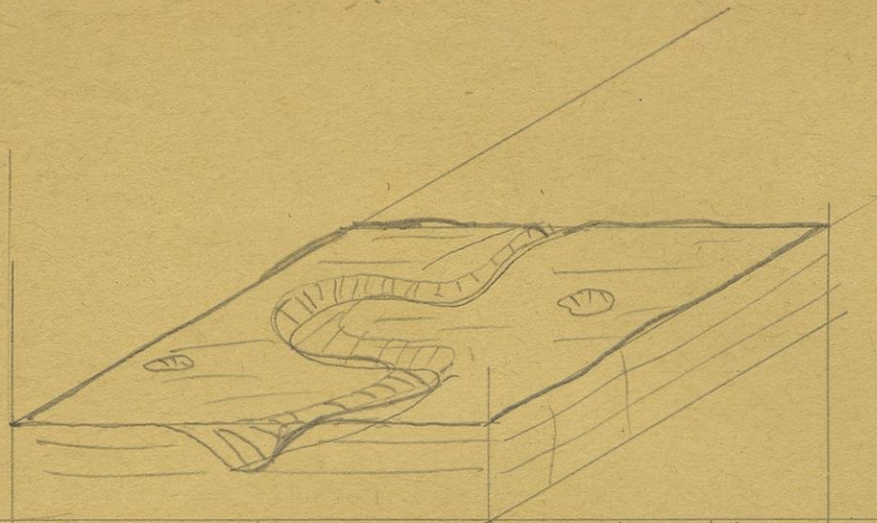

Fig 31
Craters of the Moon
Idaho
along a fissure p 25



Fig 32
Volcanic dome p 25

✓ do



27

Development of natural bridge by solution

p 19

omit



28

Completion of bridge

p 19

out

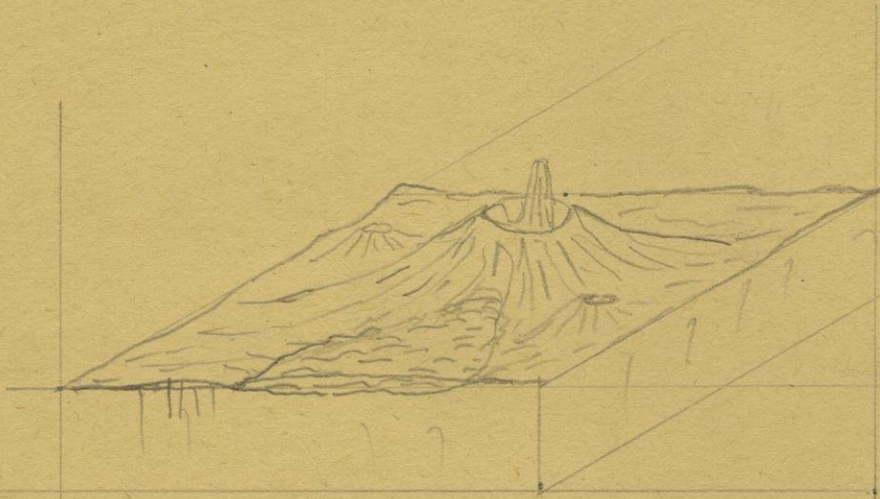

p 25

Fig. 33
Volcanic
Cone and
Spine
lava flow

mod part
34 see other
sheets

35 mod part
leg plate &
profile

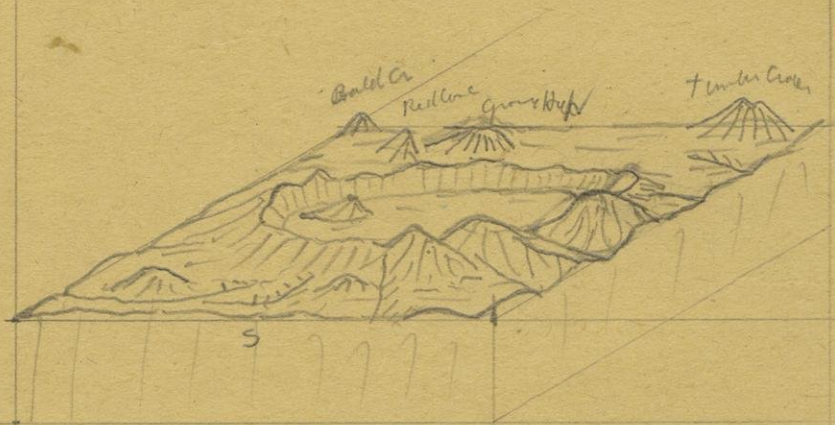

Fig 36 p 26
Crater L.
check over maps

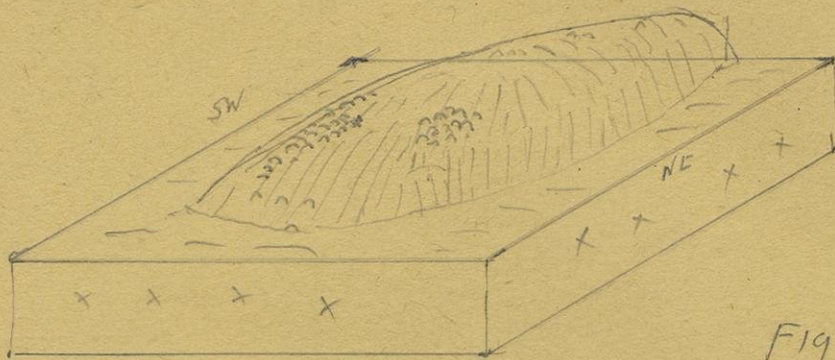

Fig 10 p10
stone Mt. Georgia
E x foliation dome

carry on W N?

map of pennsylv

p 8



omit

Fig. ~~8~~ 9

Visher GSA 56, p 732

max + 7.5 ft

Maximum recorded depth of
frost

Fig 10

isfoliation dome p10

Block diagram

look for a good photo

make a block diagram

needed ??

empty ?

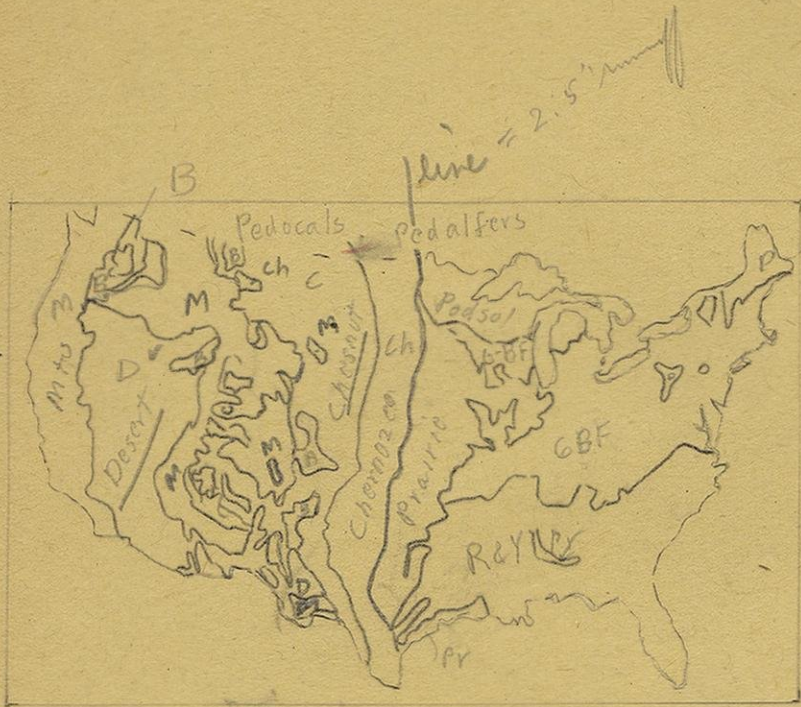











Fig 12
Soils of U.S.
Kellogg p 31

p 11

- Podsol  ✓
- GB Form  ✓
- Prairie  ✓
- Red & yellow  ✓
- Chernozem ch  } lumps
- Chesnut c  } make 
- Brown B  } make solid black
- Sierozem + Desert - D  ✓
- Mountains etc M  black

pedalfers

Pedocals

omit

lumps

needed??

A ₀	Organic remains
A ₁	Dark from organic matter
A ₂	Light colored from leaching or reduction (bleicheerde of Podsol) absent in dry regions
A ₃	Transition
B ₁	Transition
B ₂	Deep colored, dense, high in colloids, iron oxide (ortstein of podsol)
B ₃	Transition
C	"Parent material" = material formed by inorganic processes only
	Unaltered parent material

Fig. 11 Soil Profile (after Kellogg) p 4

p 11
omit

Fig 4

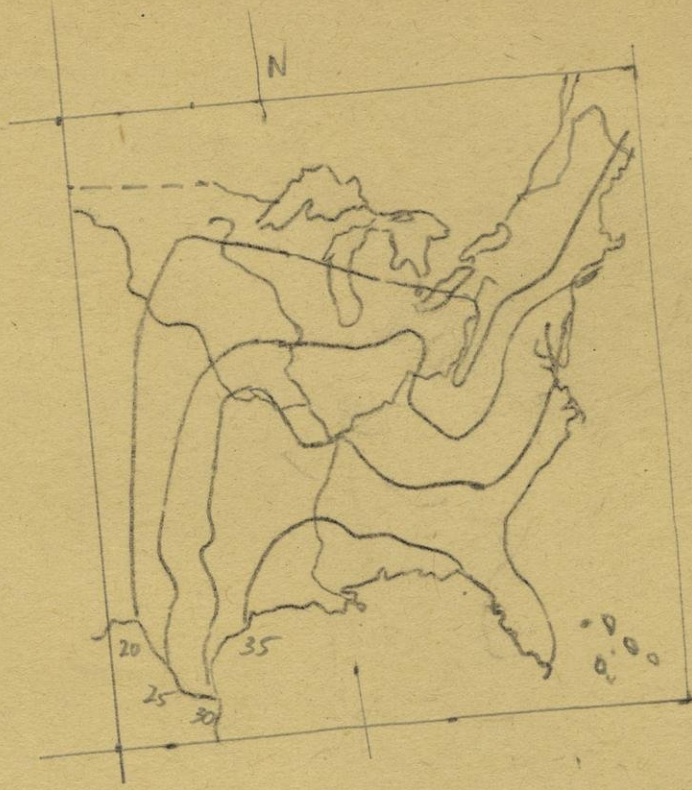
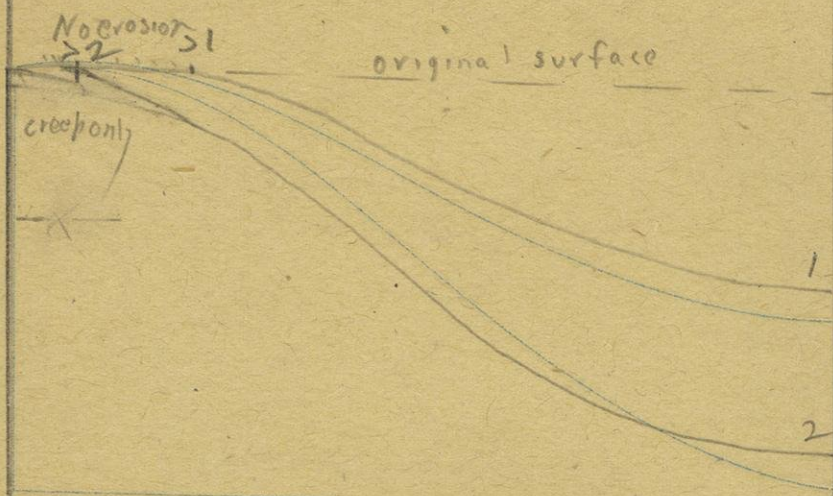

Fig 6 . Evaporation losses in eastern United States from WSP 846

out
duplexer other
p 3



✓ Fig 81

lowering of valley from 1 to 2 decreases width of belt of no erosion by increase of slope
p47



✓

Fig 82

more rapid downward erosion than slope wash produces convex slope
no sharp boundary because of rare torrential rains
p47

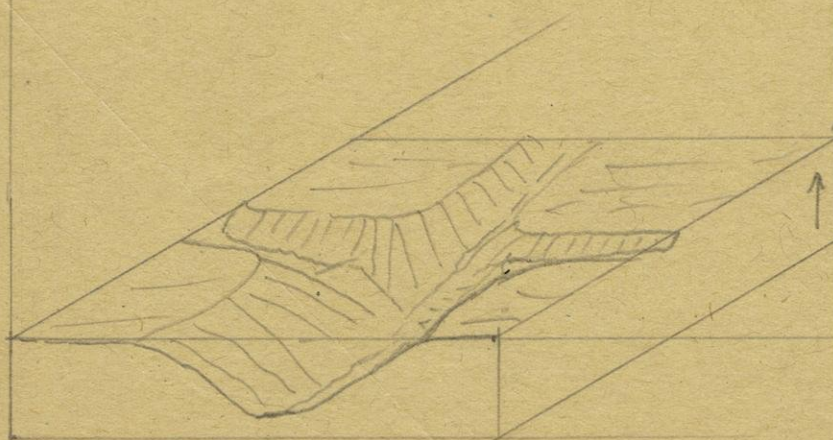

Fig 83 p48

(a). Hanging valley due to tilt which accelerated mainstream only or greater volume of mainstream
(b) much



Fig 84
cut bank and
lateral erosion
 $f = \frac{m s^2}{r}$ p 48
r = radius of curve



Fig 85
Effect of
filling p 48

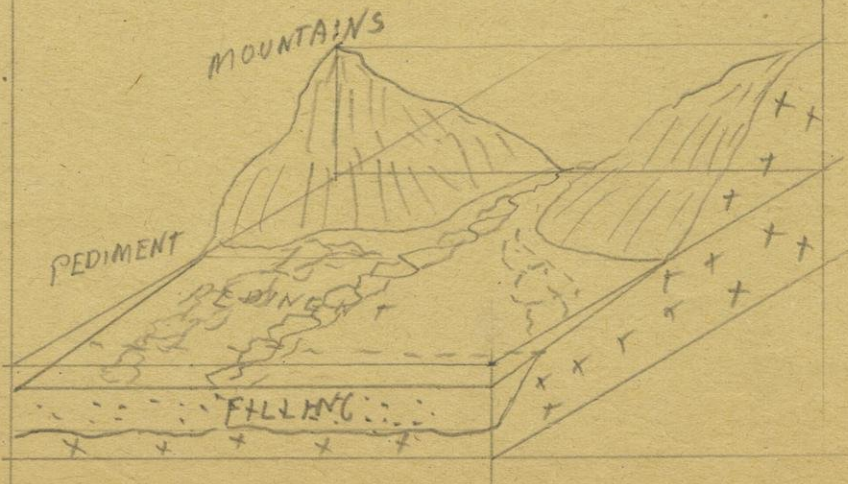

Fig 86
Formation of
pediment at
foot of
mountains

p 48

do

Fig 77 b 45

Braided stream

Matiniska valley, Alaska
from aerial photo



C14 2:79

dw

1:20000

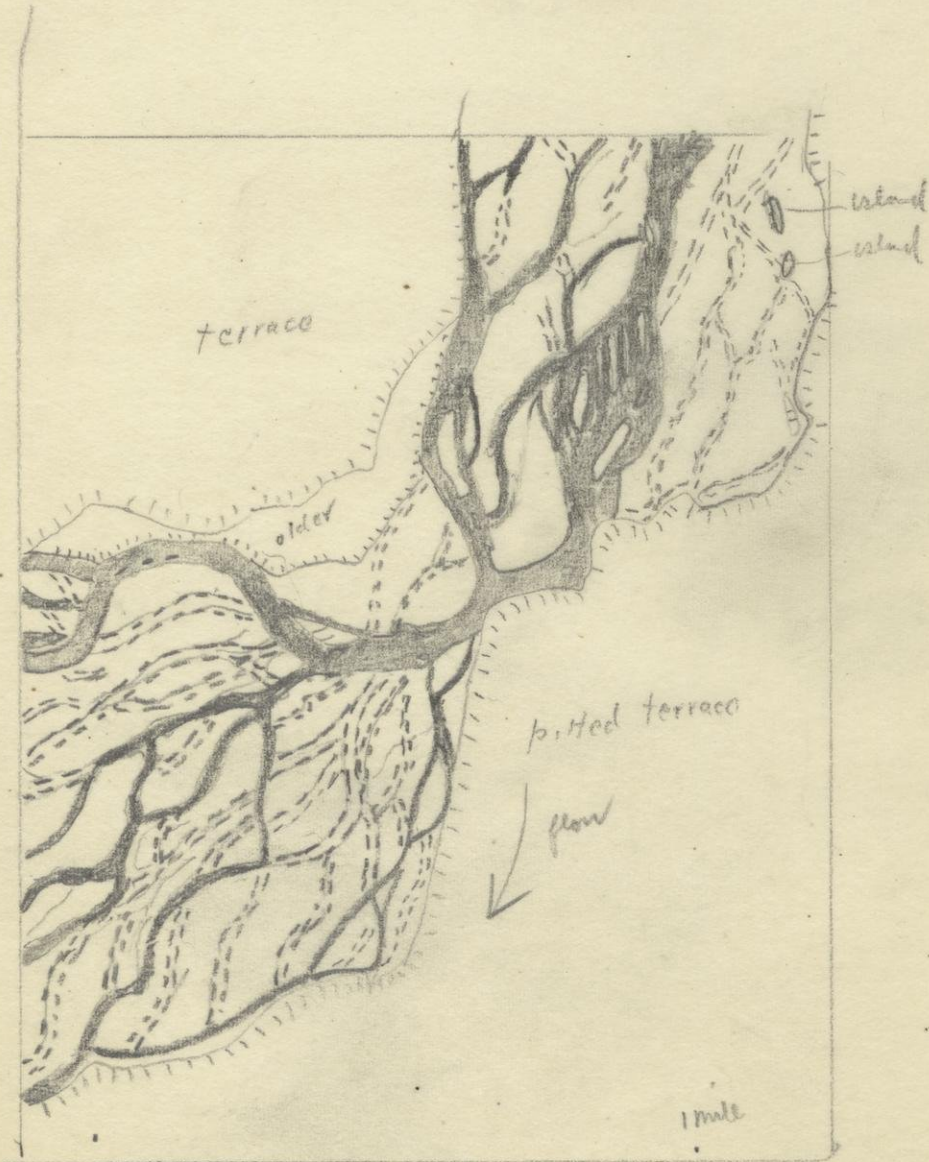

There is a good one in
HTV Smith might be better

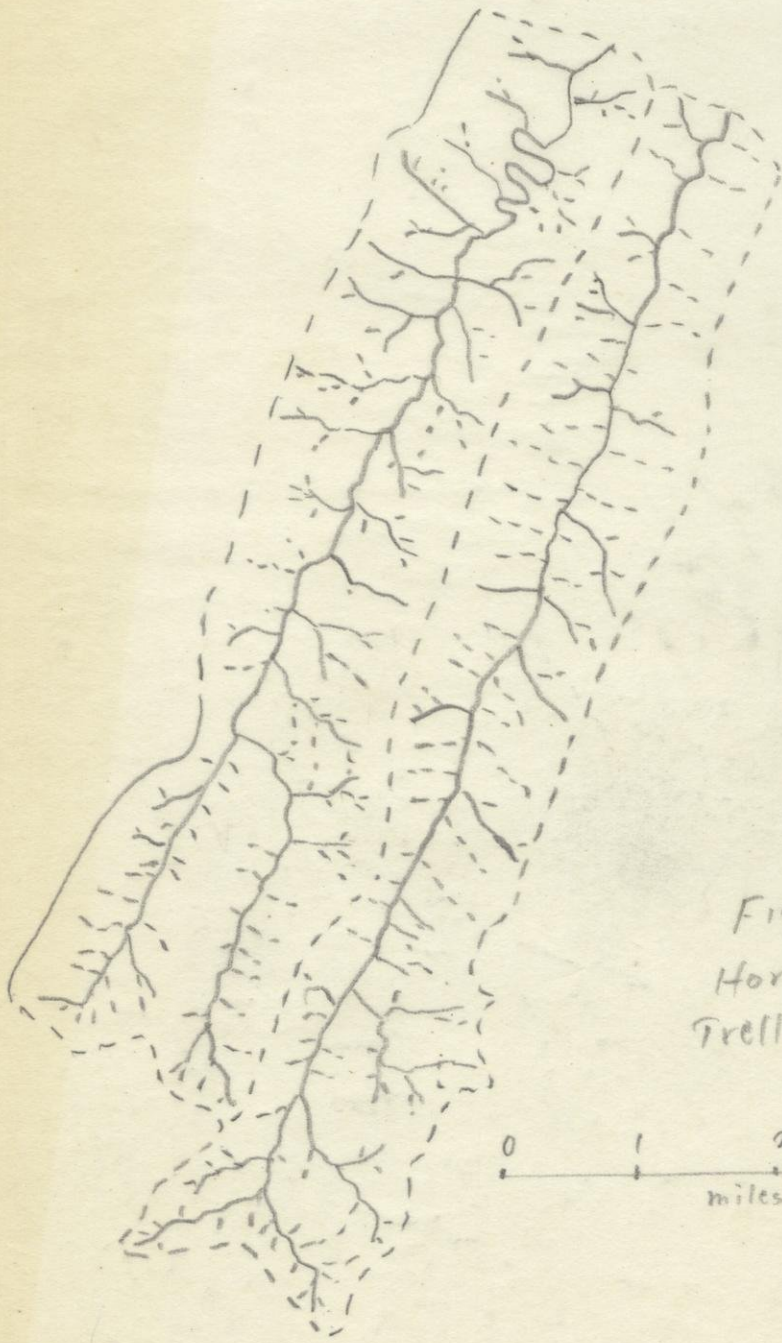
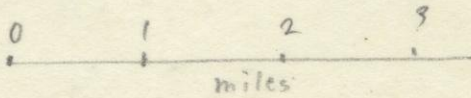

Fig 76
Horton Fig 9 p 45
Trellis



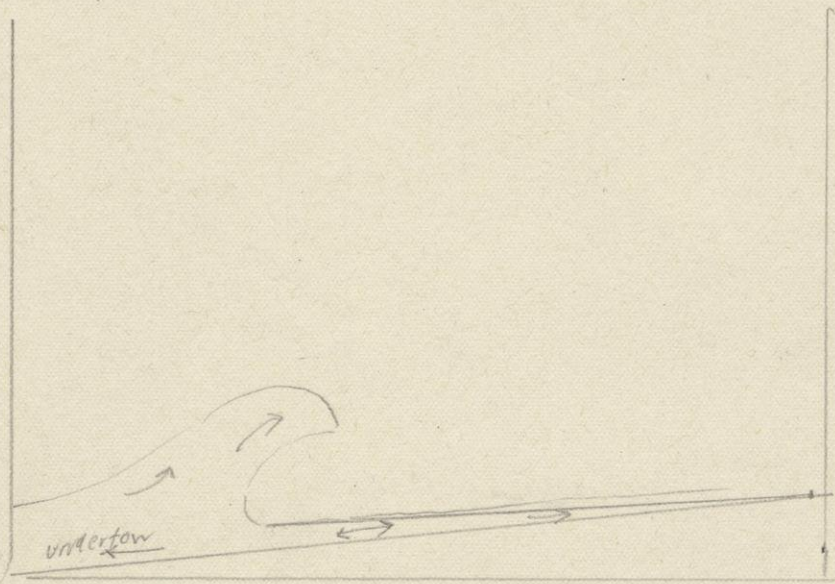

Fig 121
breaking wave after beach water
flows up the beach - Then back again under next wave

see long for details

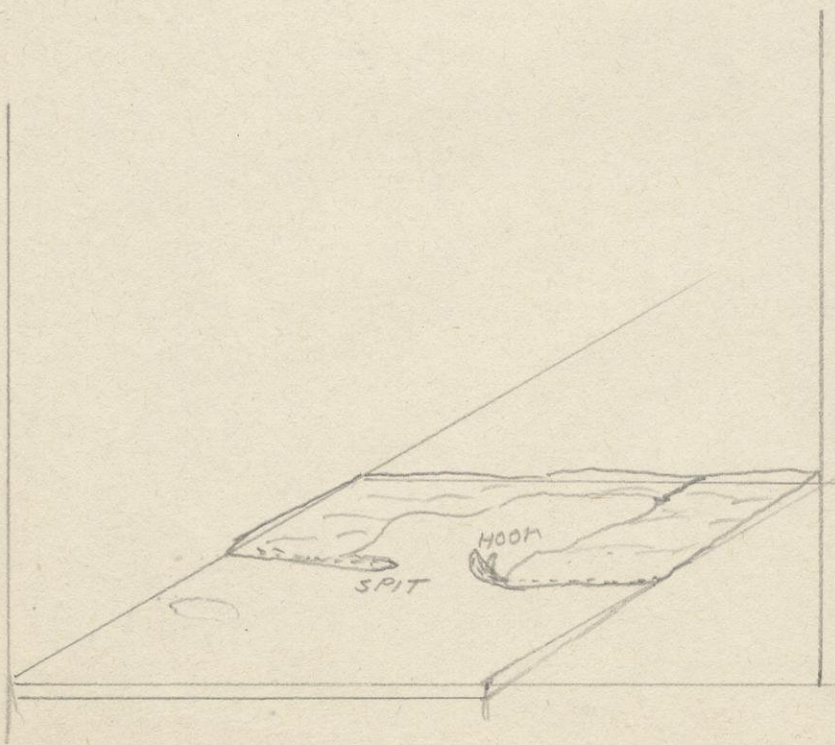

Fig 130
Spit and Hook

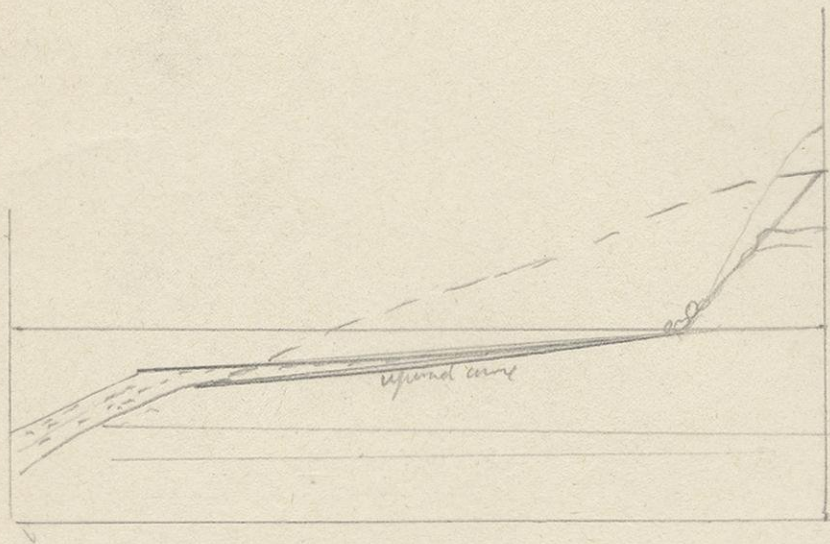

FIG 127
 Subaqueous
 terrace
 showing the cover,
 slide material
 boulder line, cliff

"Low and Ball" after Evans

vert scale X 5

~~see next page~~

J. 6. 48

F 128

done

$$\text{depth} = \text{const} \times \text{distance}^{7/10}$$

$$\text{vertical} \pm \text{const} \times \text{distance}^{35/100}$$
 distance from shore

237.
 60-
 1094

$\frac{12}{1094} \frac{699}{12} = .00915$
 $\frac{8}{602} = 0132$
 $\frac{4.1}{237.0173}$

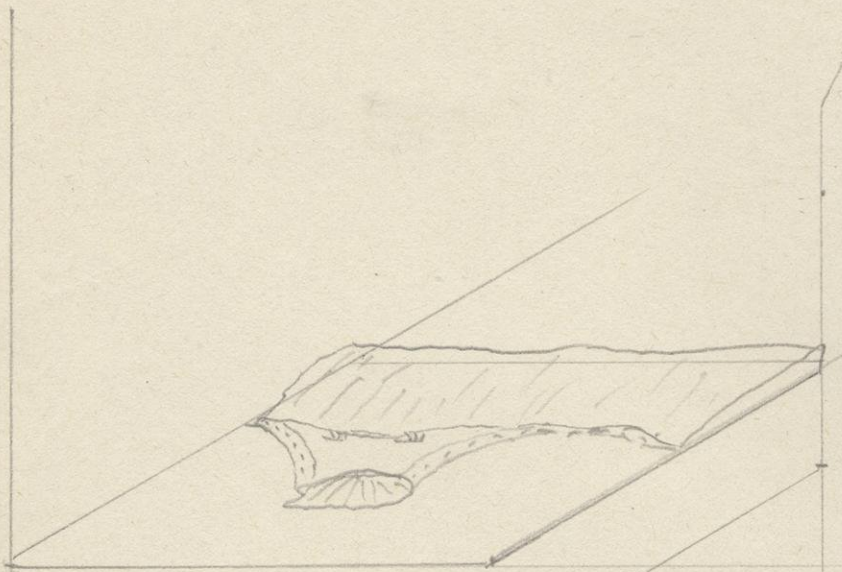

Fig 131
tombolo, double
Some have only one
ridge

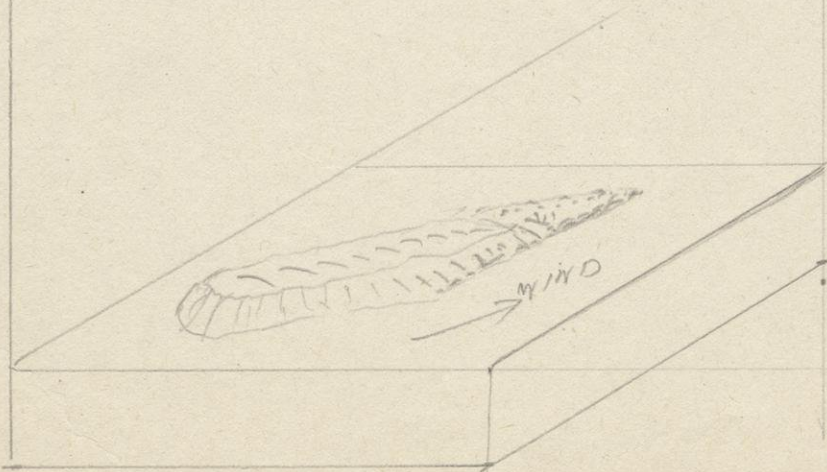
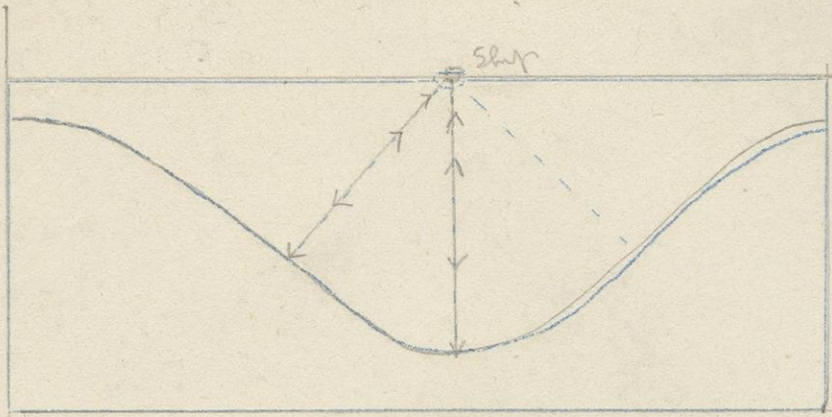

Fig 132
Bar in level land
looped bar (Johnson)

Fig 142
Echo sounding



dive

p 68

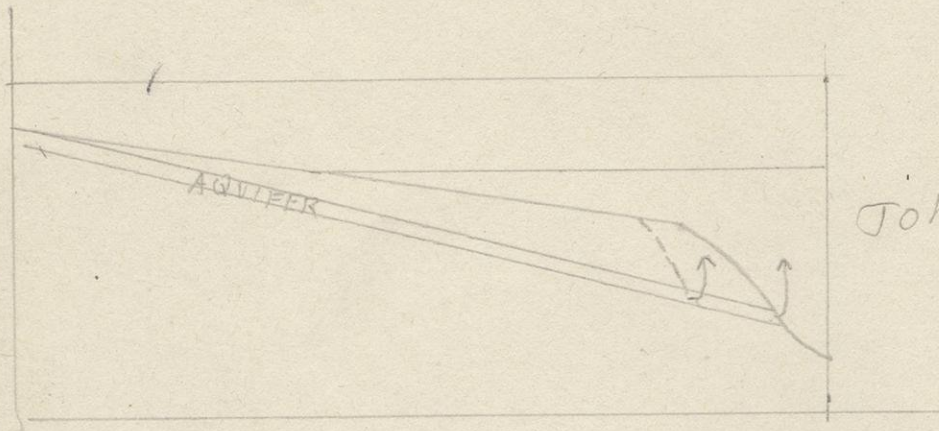

Fig 147

Johnson's hypothesis

p 69

p 68

Fig 166 p75
Cross section of whaleback
after Baguld p 243

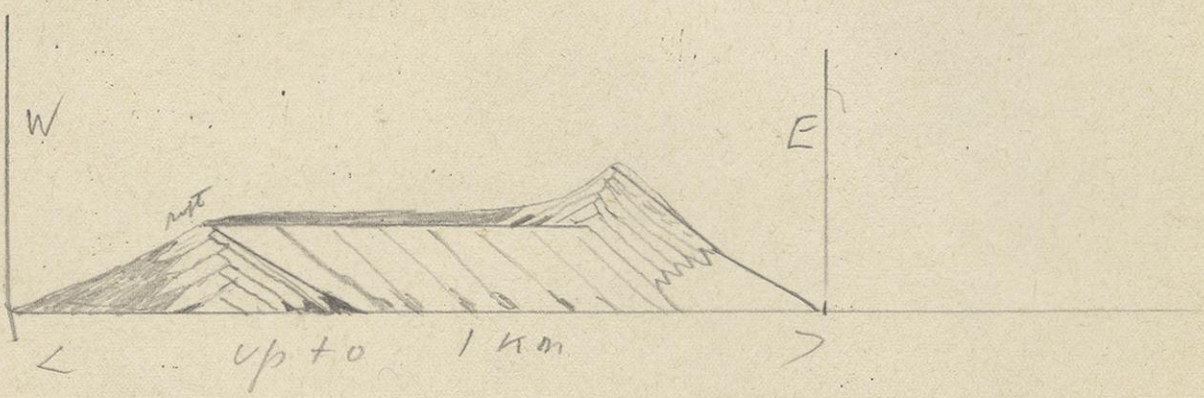

Fig 155 h 73
 Big Hollow use top map

Fig 156 yarding GSA 45:159

p 73

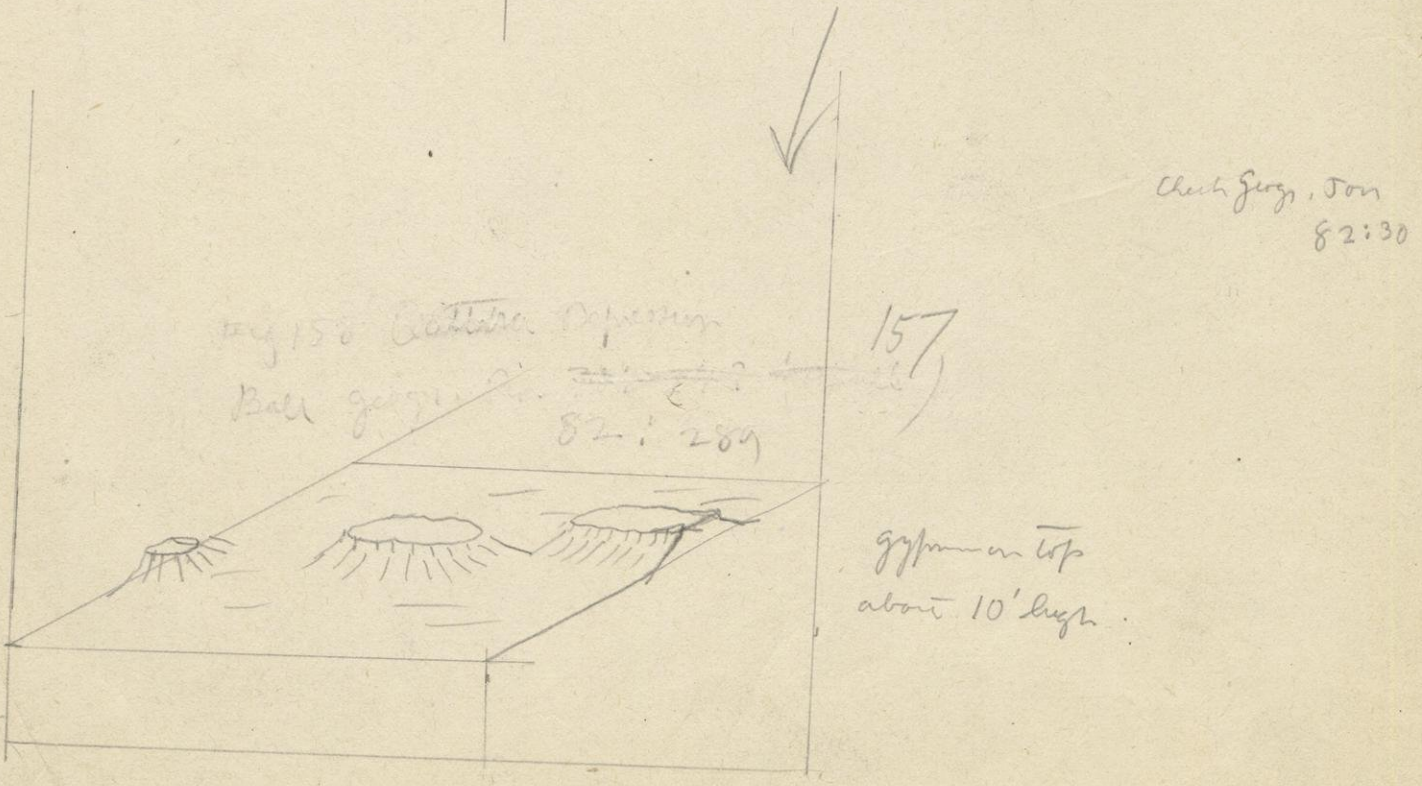
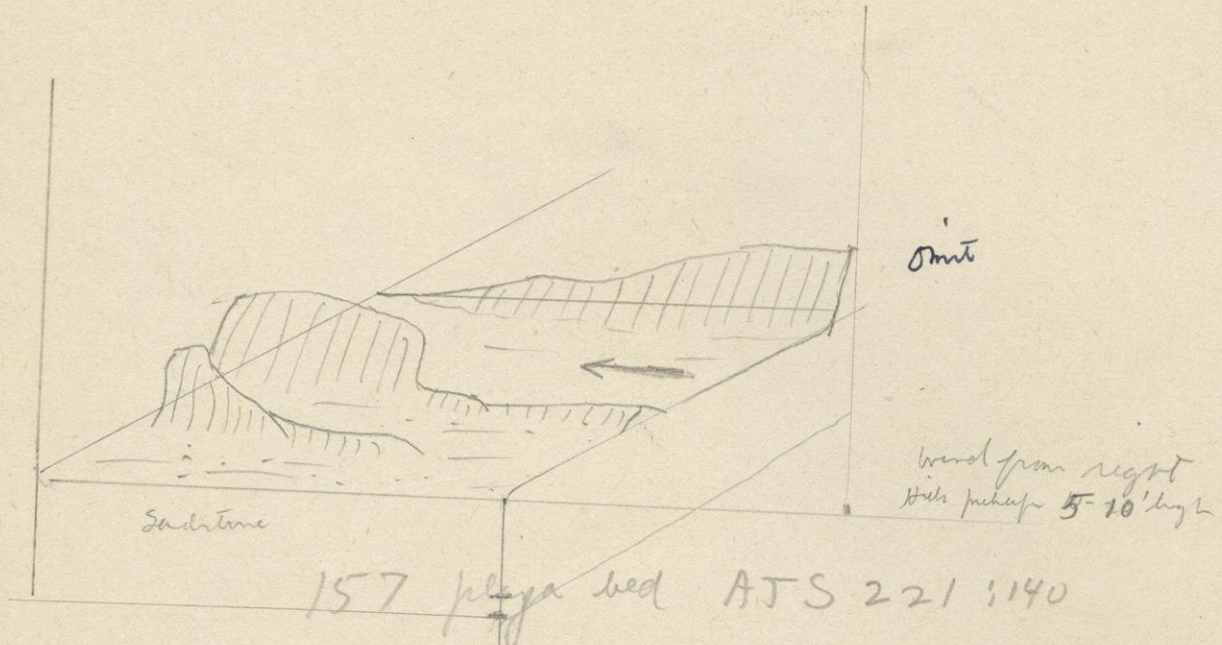
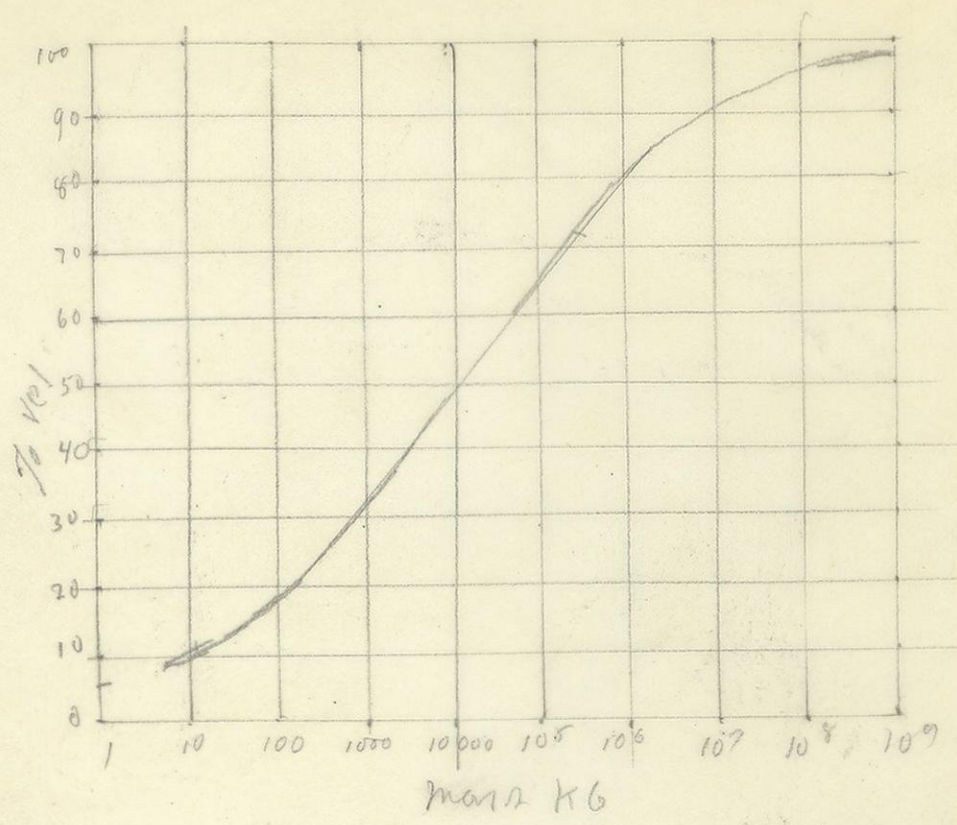
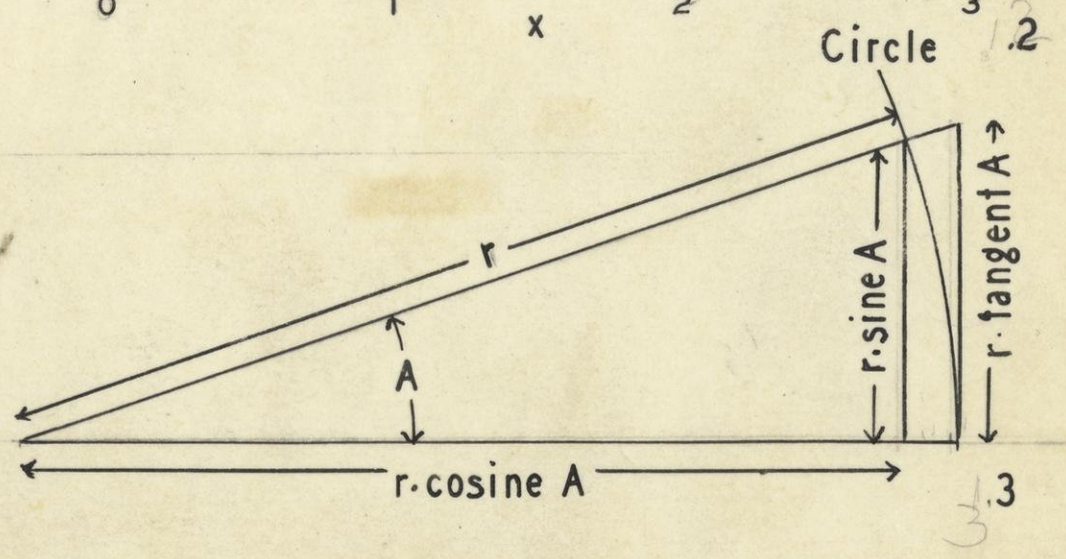
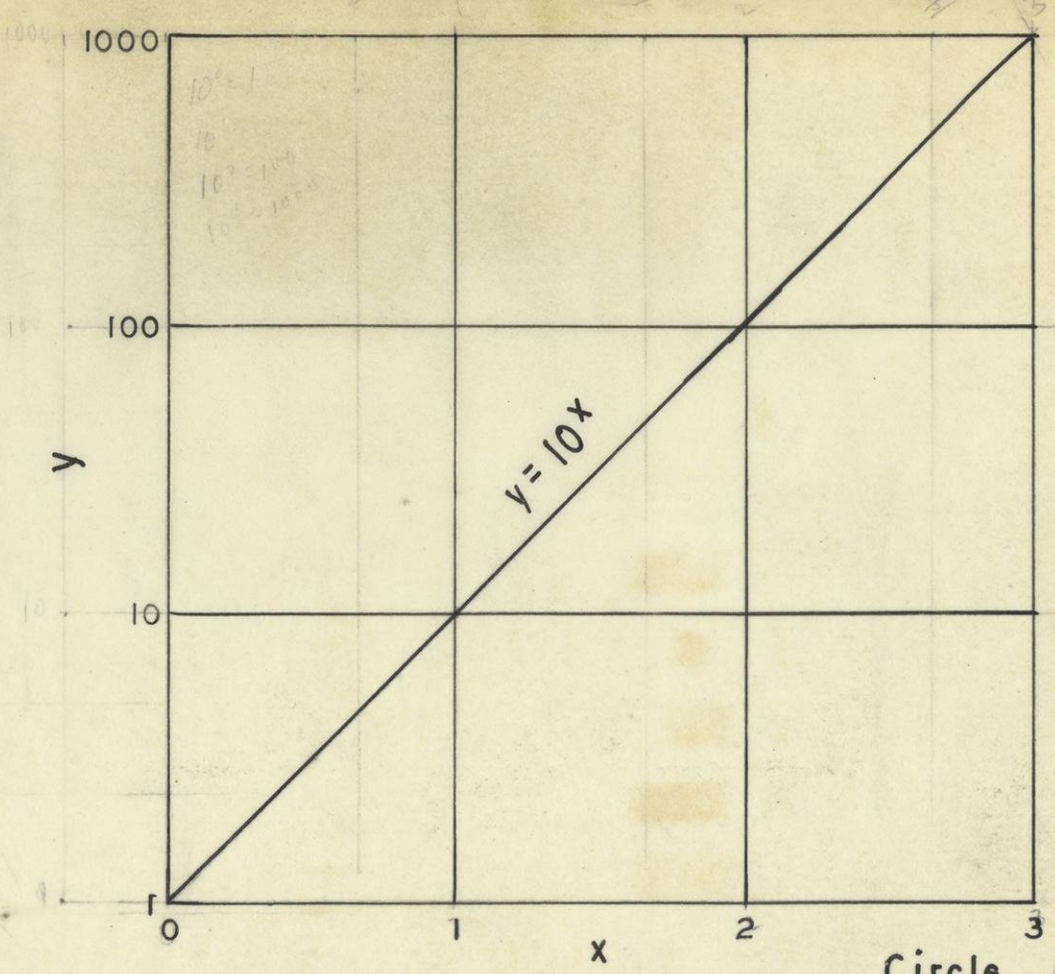
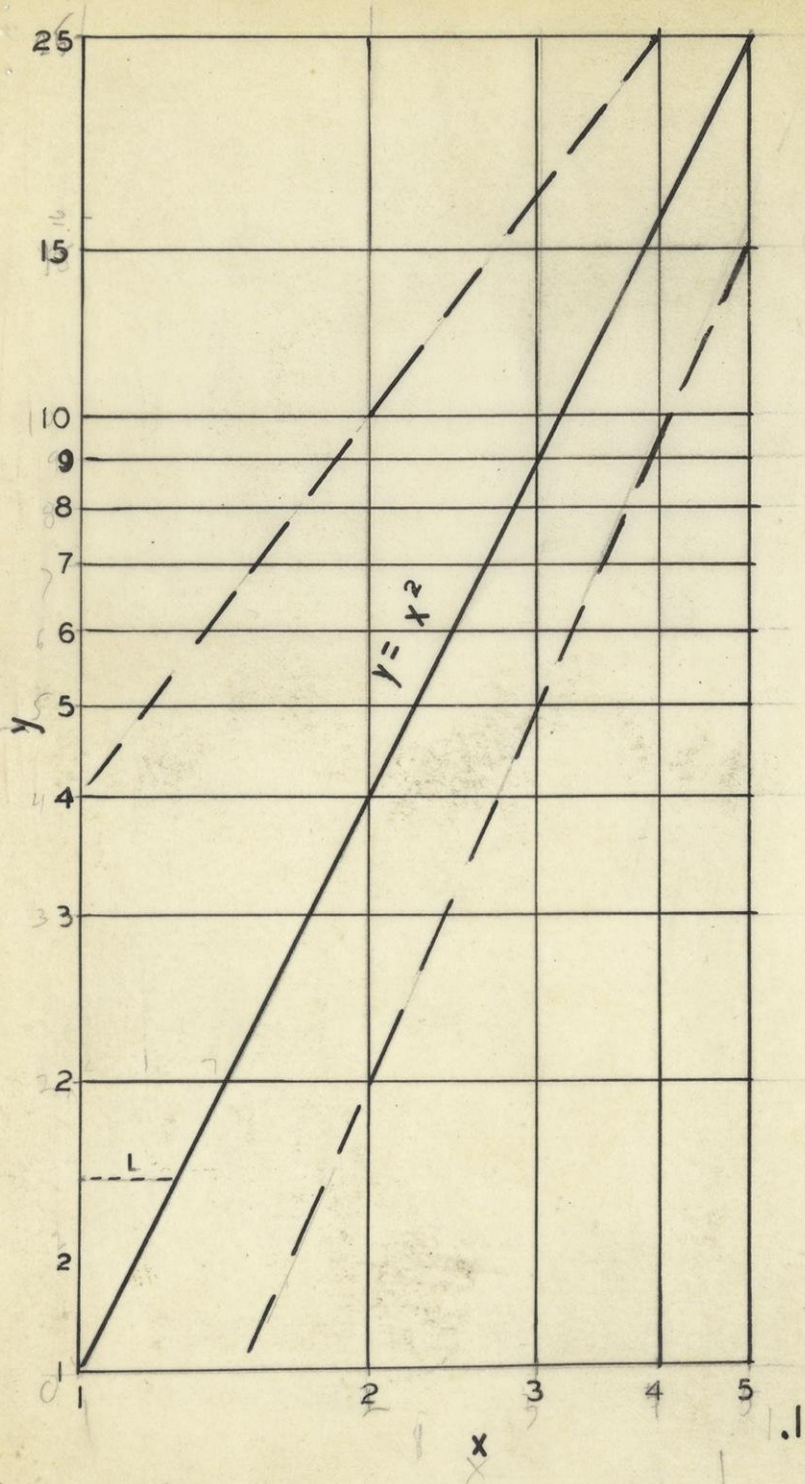
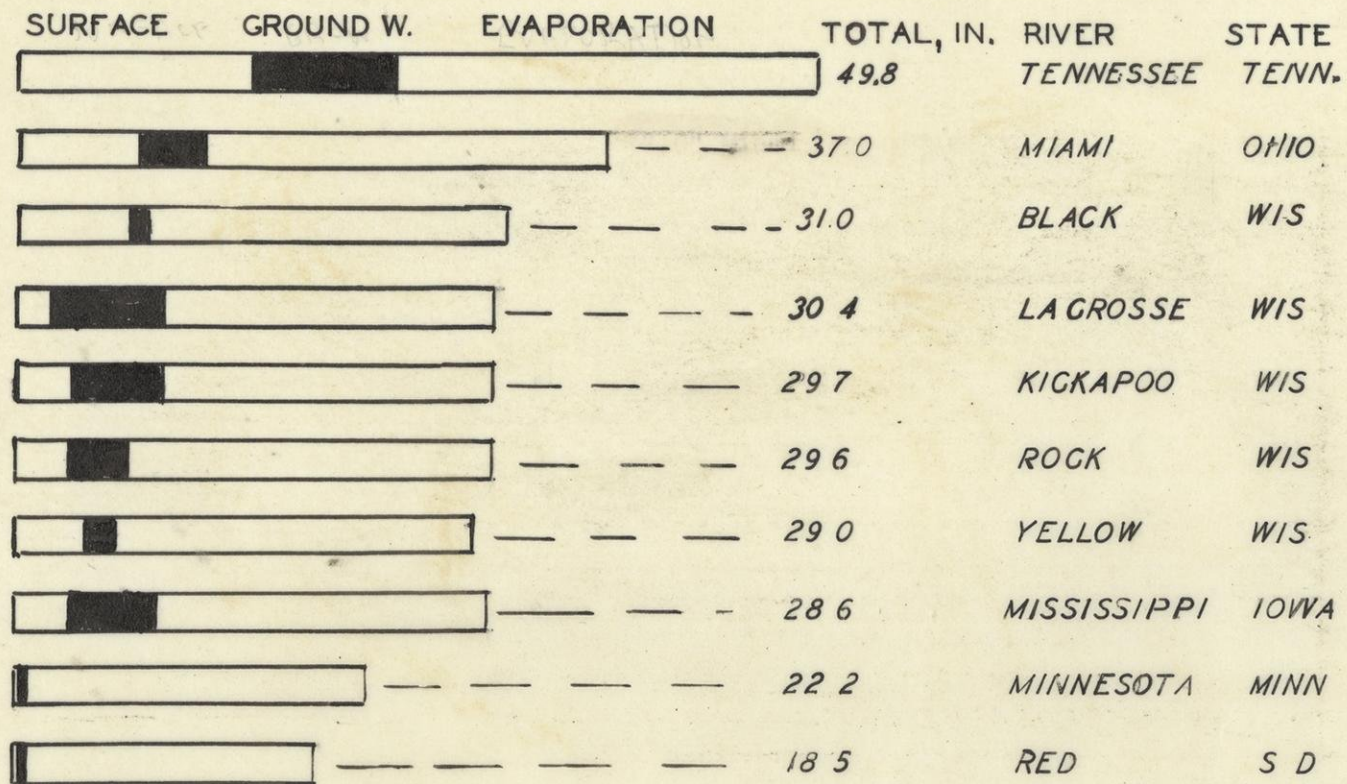

Fig 158 Qattara Depression
 70 82
 Geog. Rev 82:289







1.2

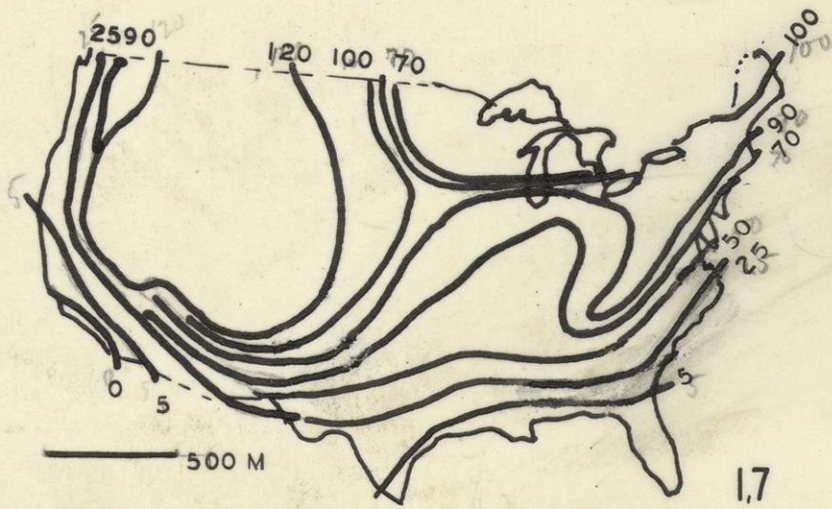
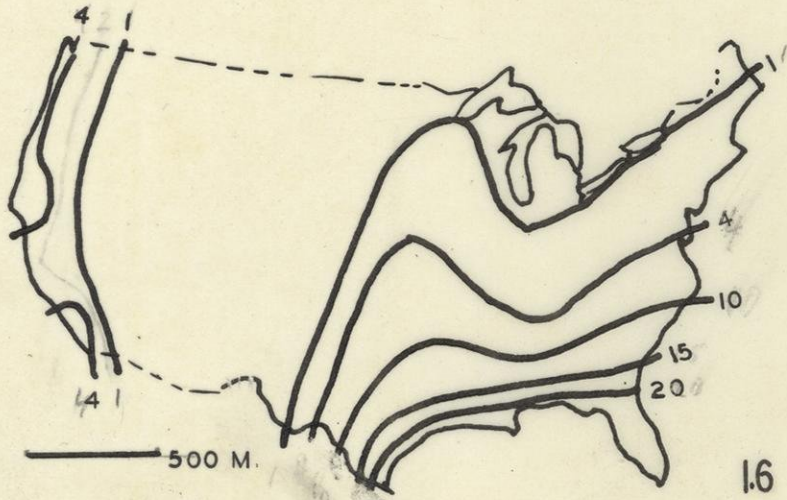

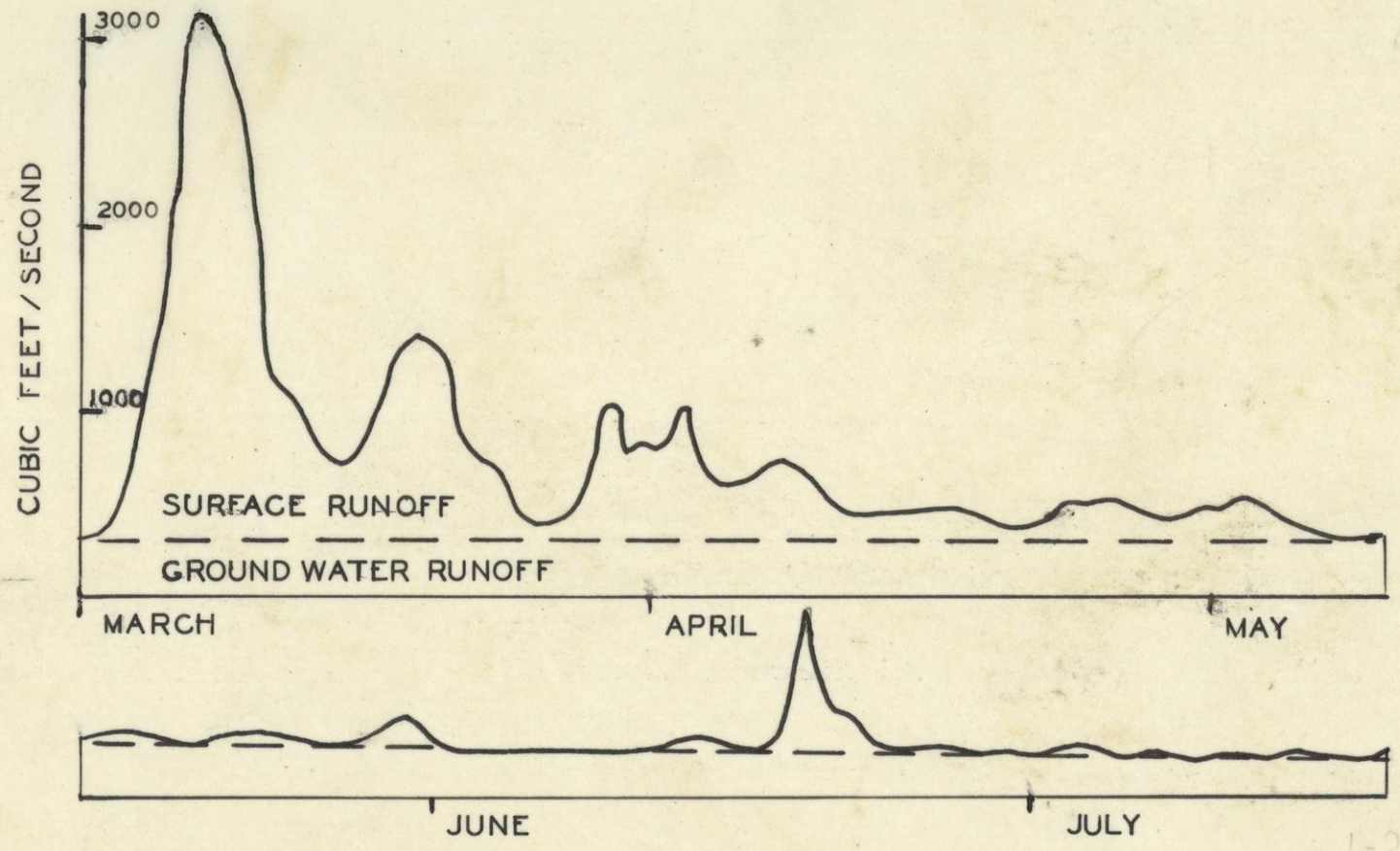
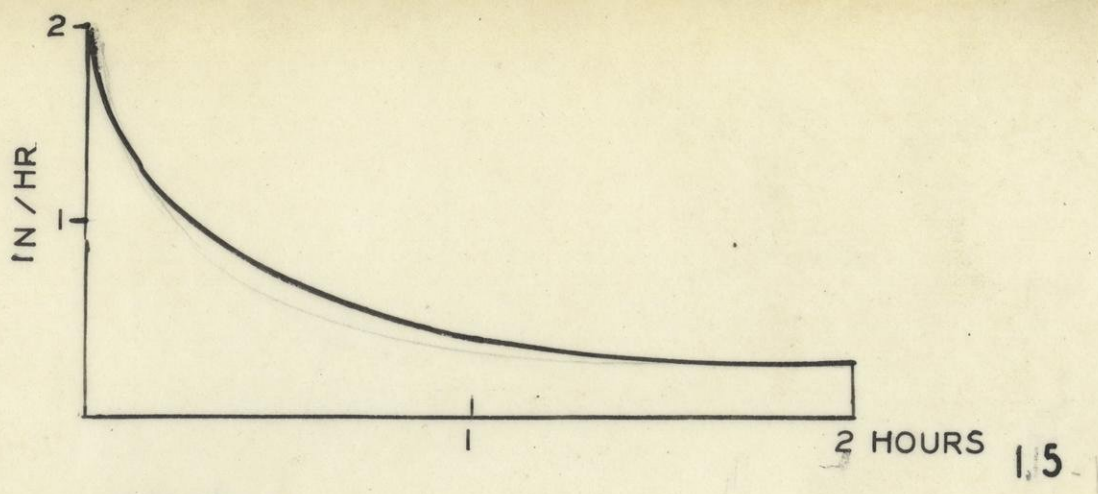

1-2 1.1

1.1

W. J. ...

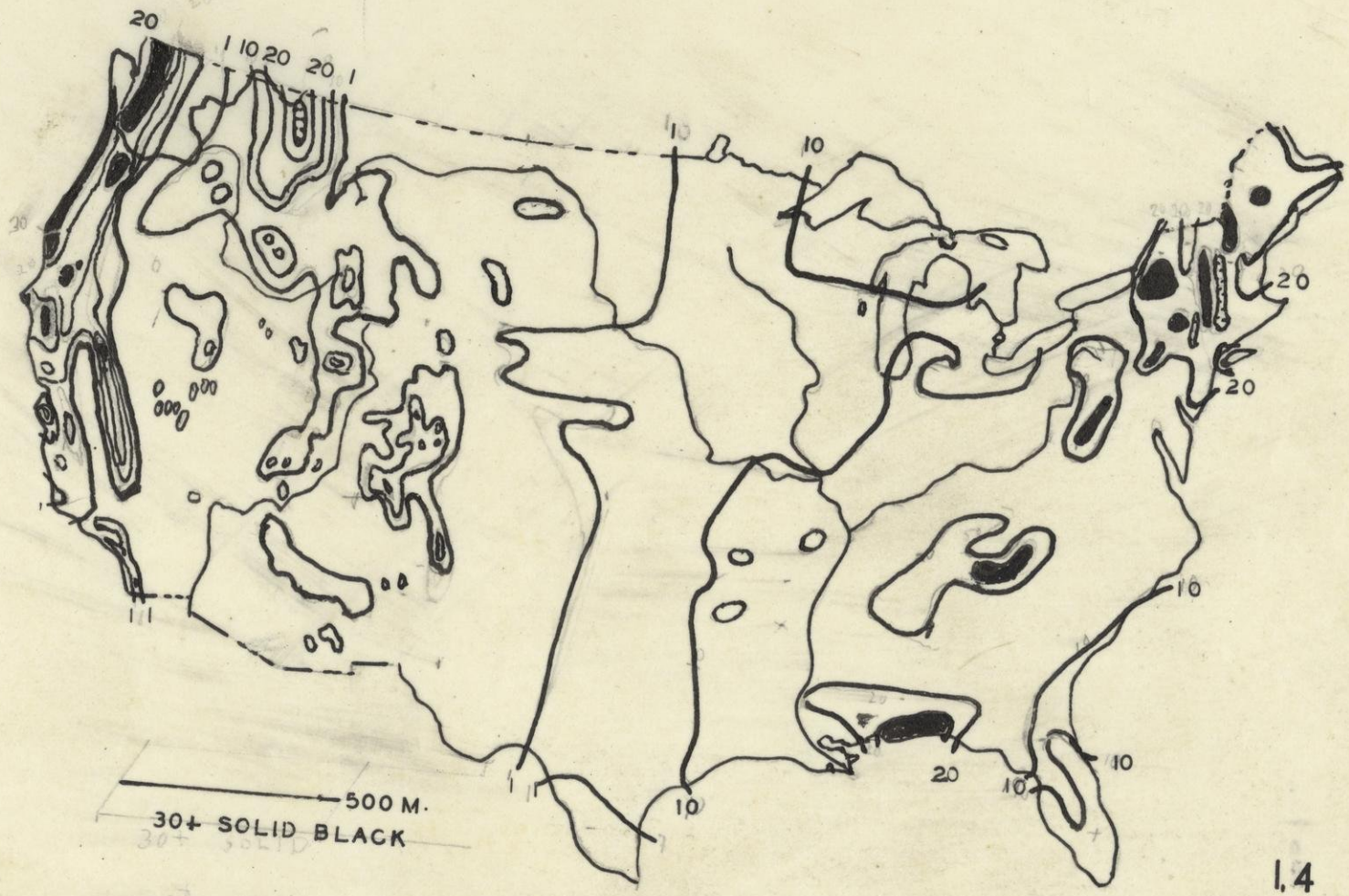

1.4

1.7

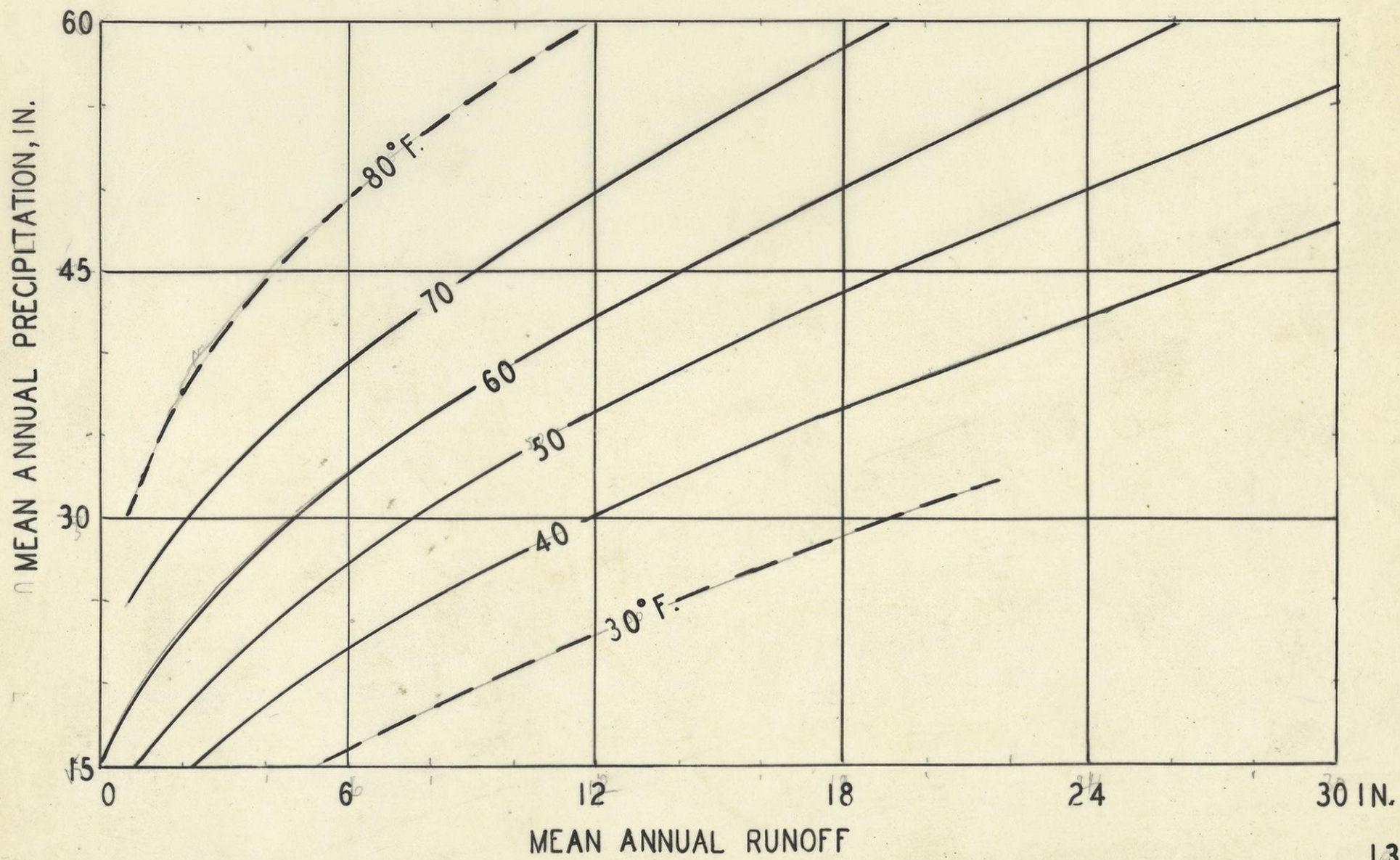

1.3

1.3

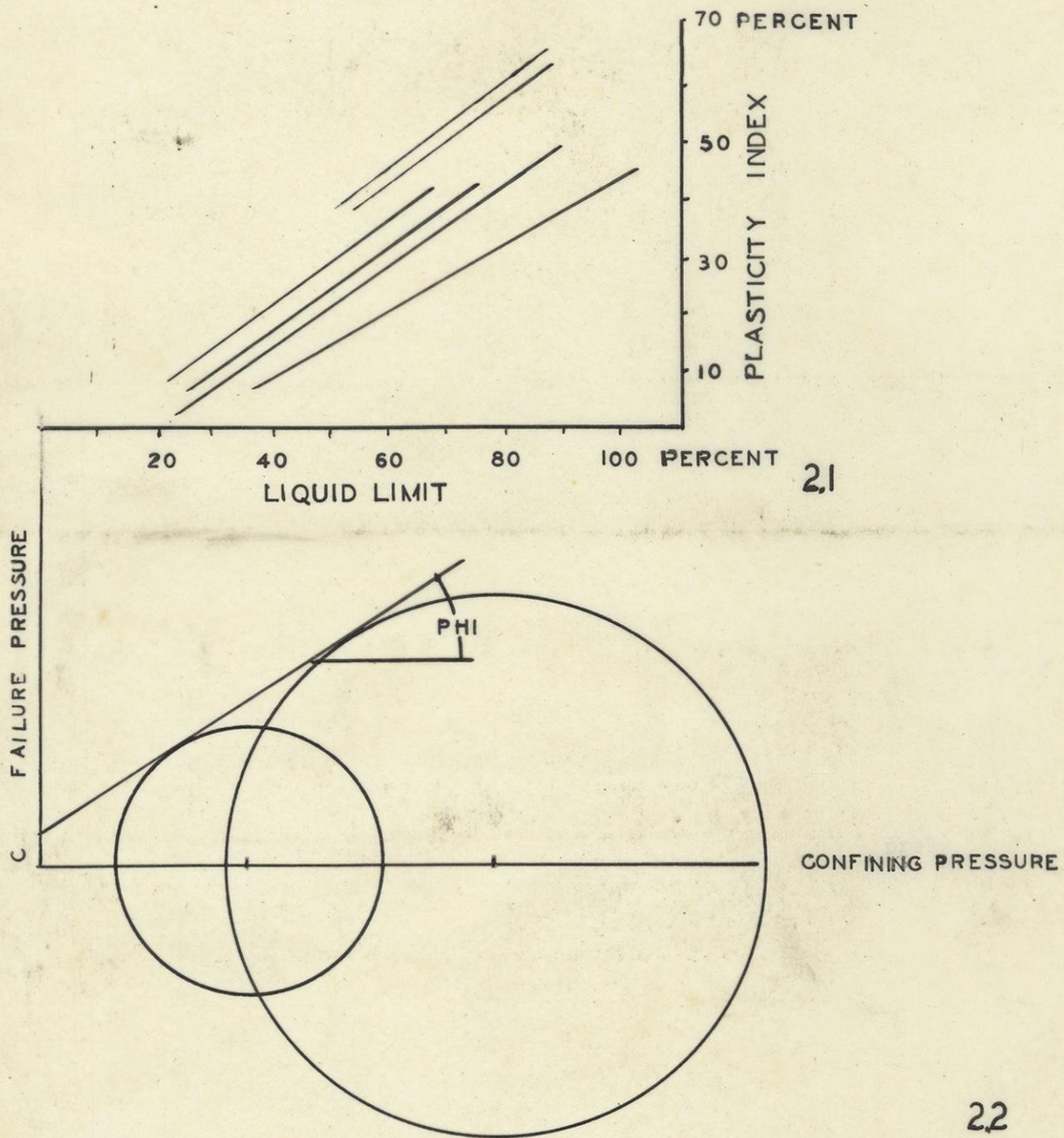

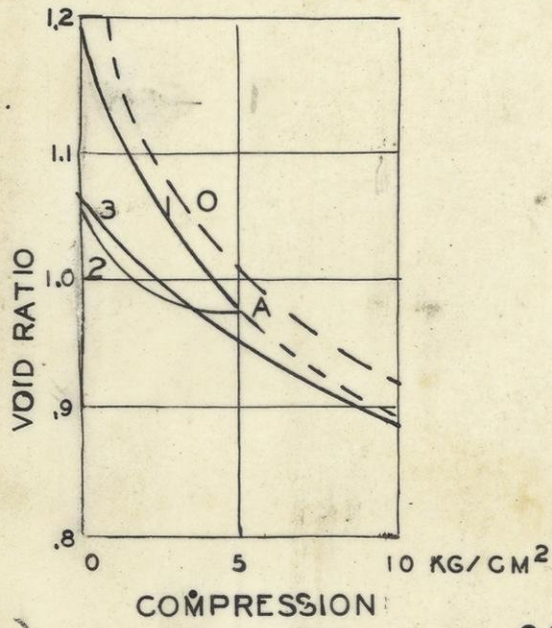

2.3

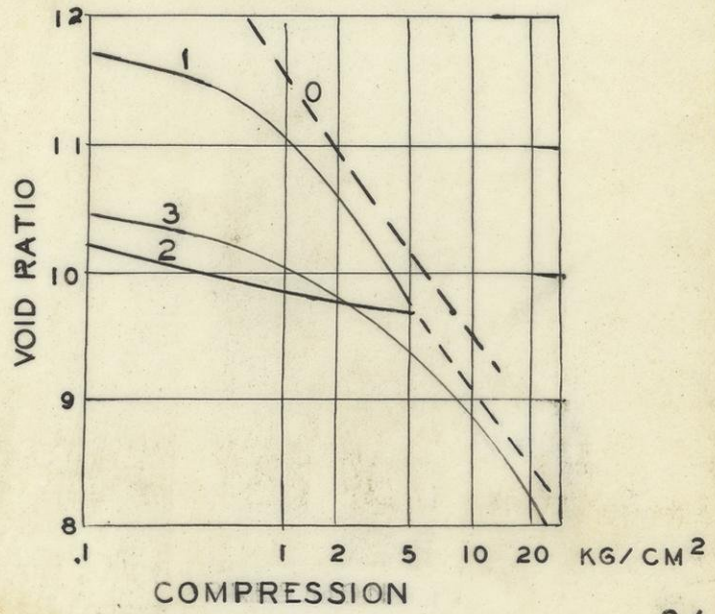

2.4

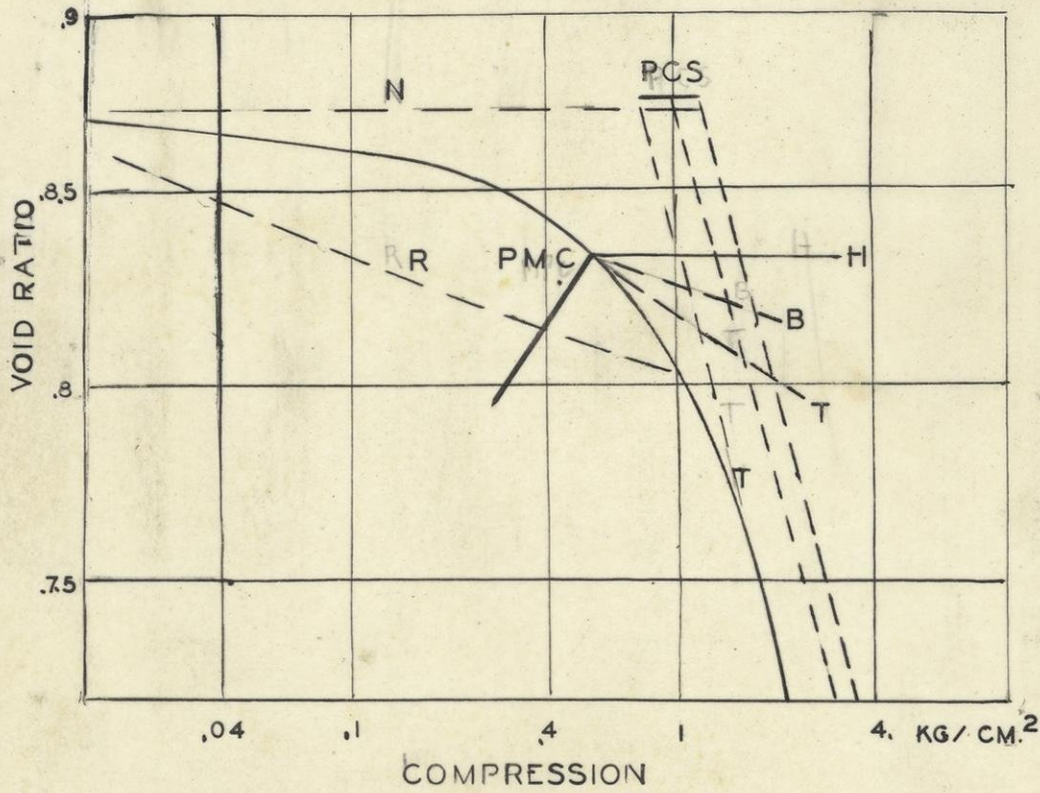

2.5

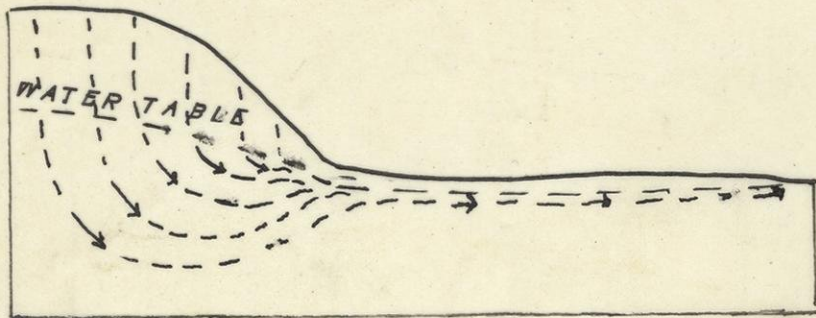

3.1

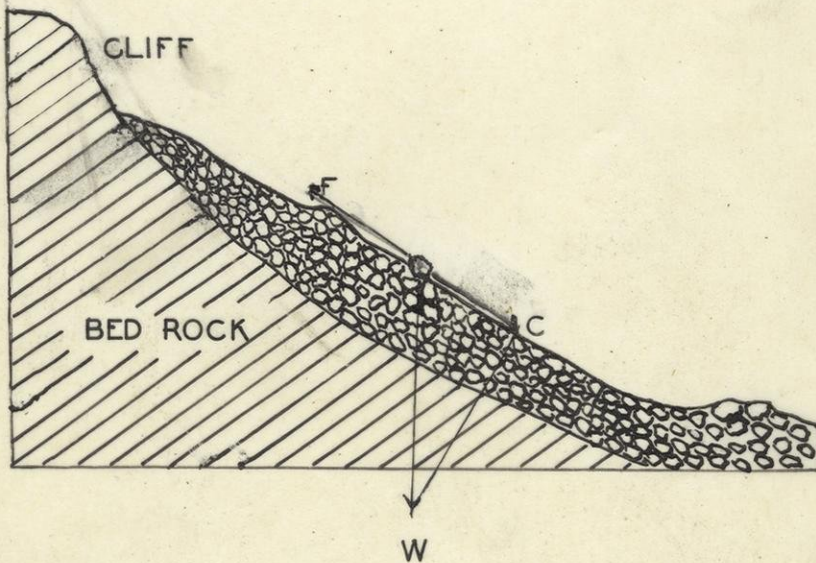

3.3

33

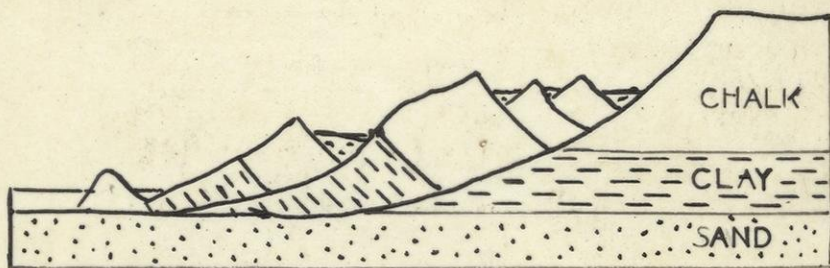

3.4

34

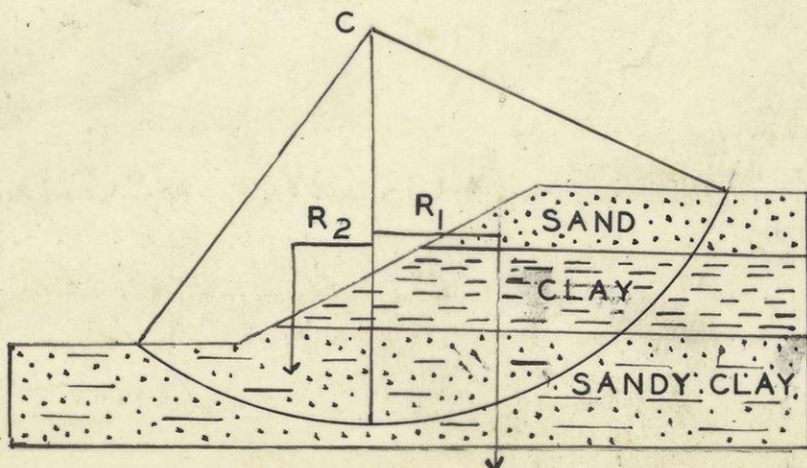

3.5

$$f = (1.25 \times 10^{-4}) h^2$$

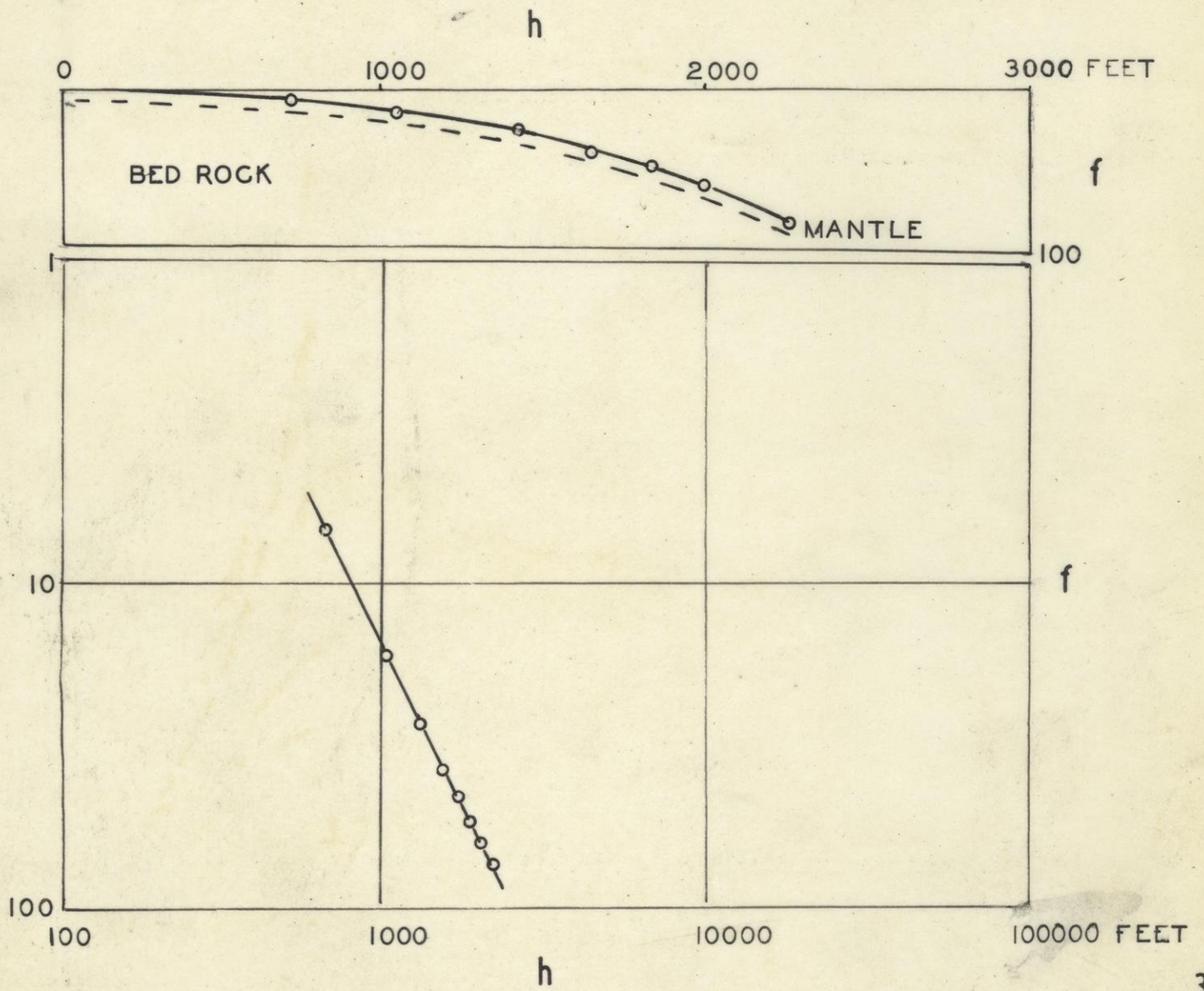

3.8

3.8

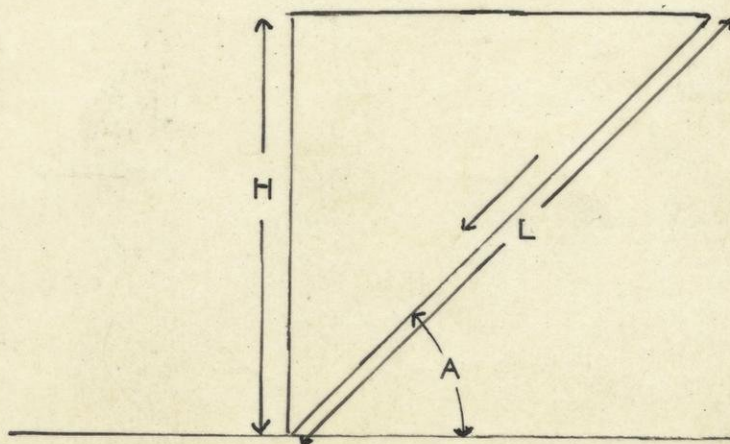

3.2

3.2

3-2

TOP OF BANK

-18 -16 -14 -12 -10 -8 -6 -4 -2 0°C

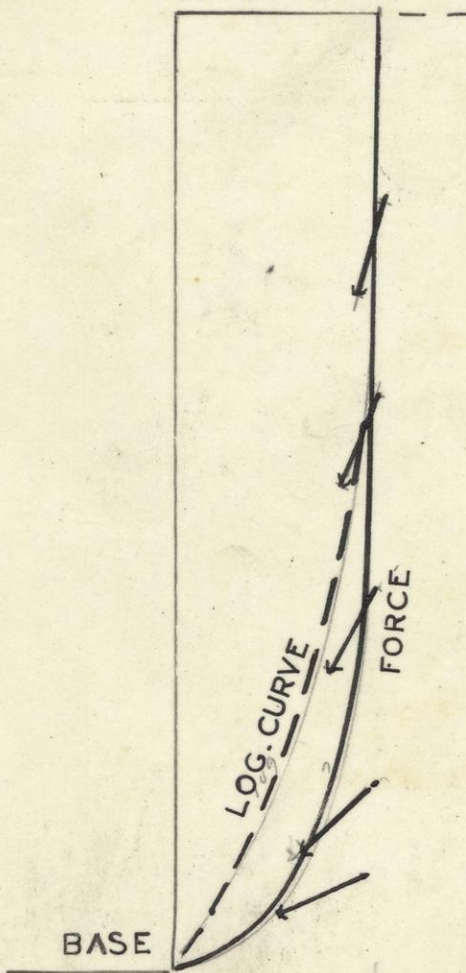

3.7

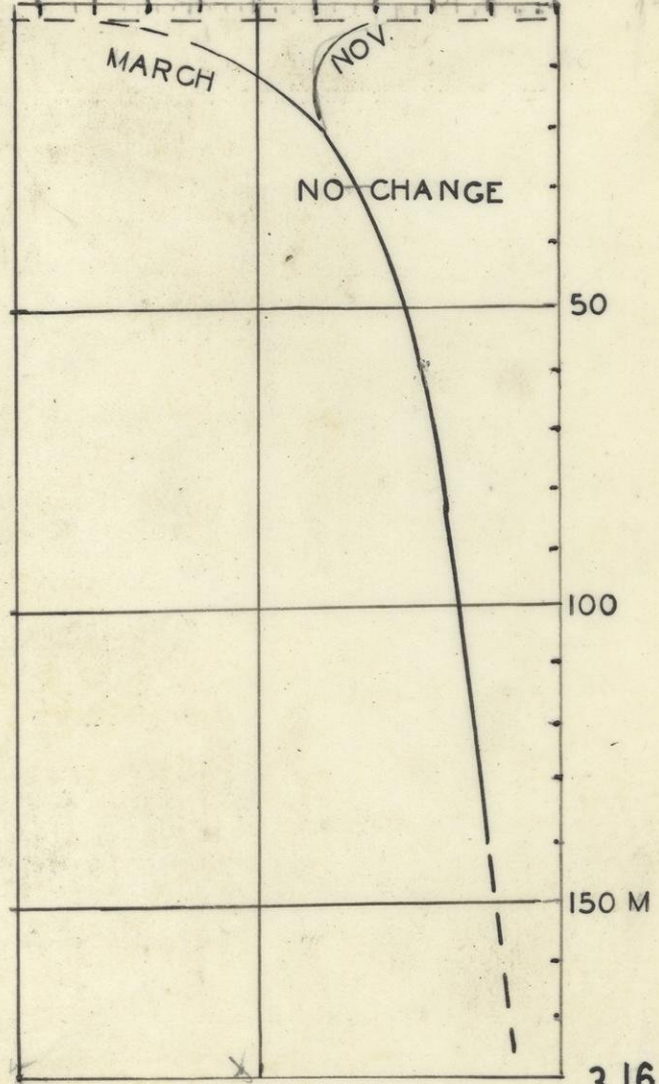

3.16

3.16

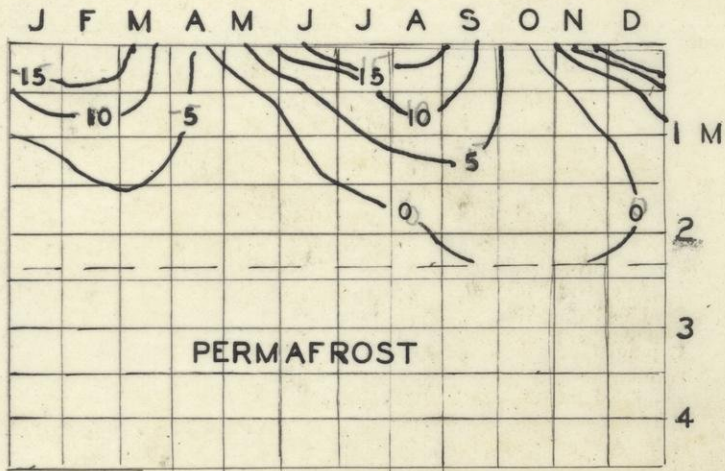

3.15

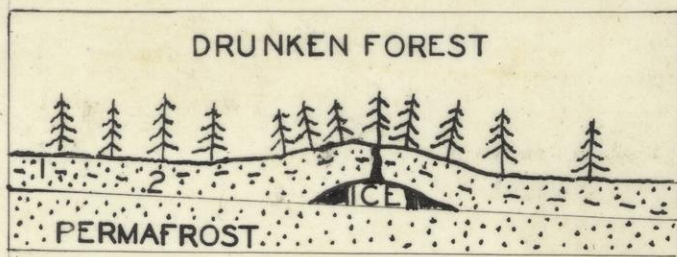

3.17

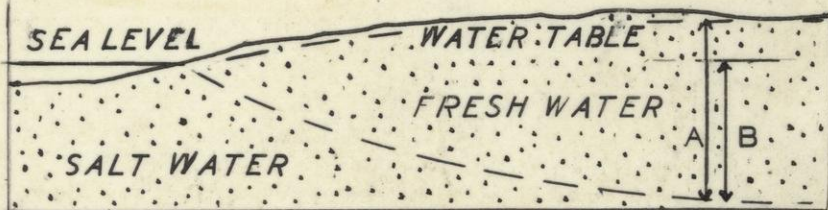

3.10

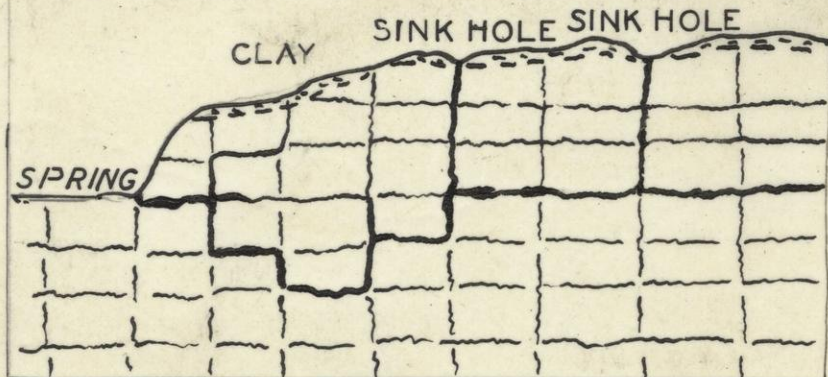

3.82

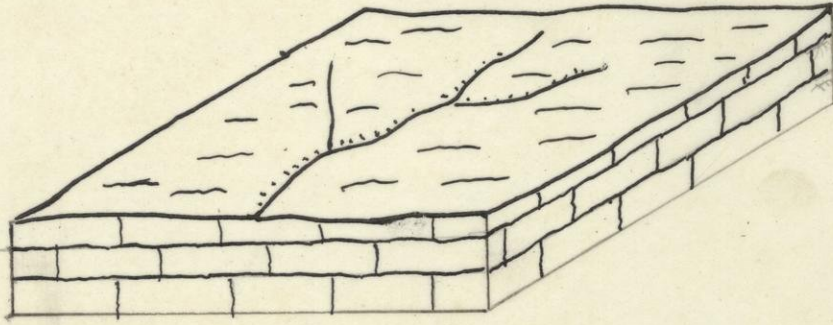

3.11

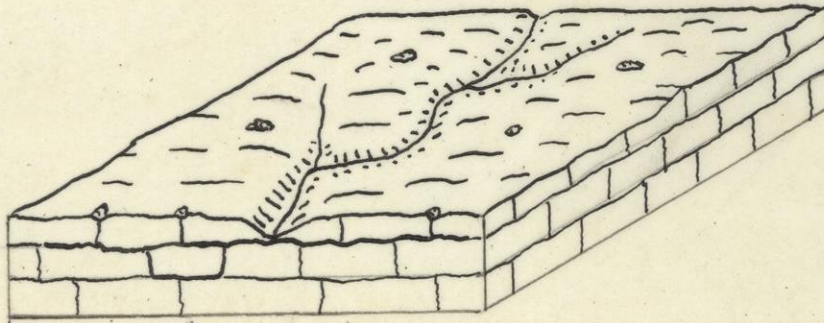

3.12

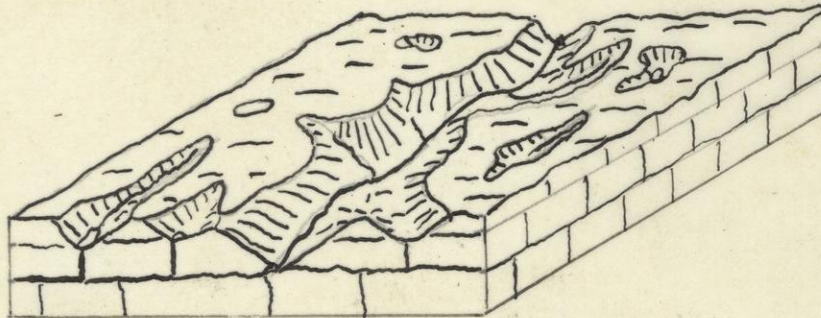

3.13

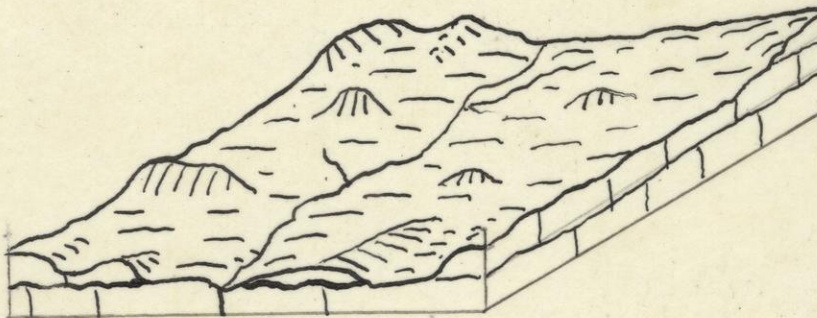

3.14

51

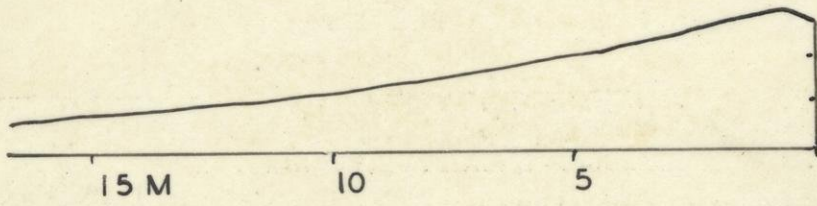

MAUNA LOA

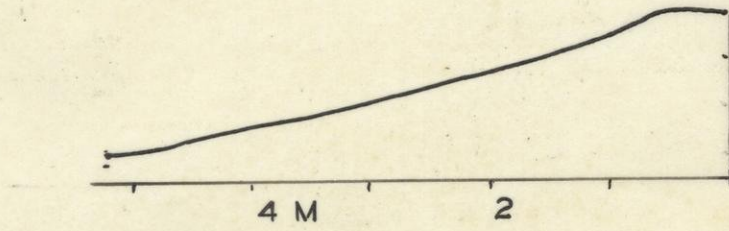

MT HOOD

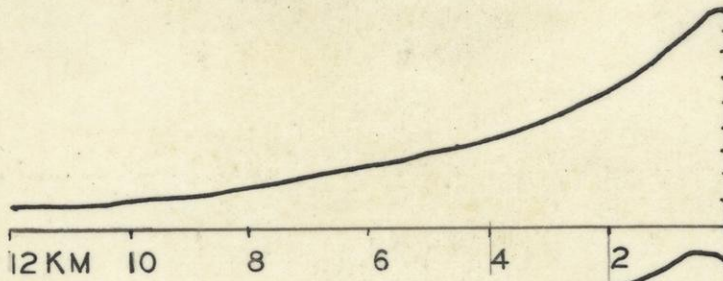

FUJIYAMA



VESUVIUS

5.1

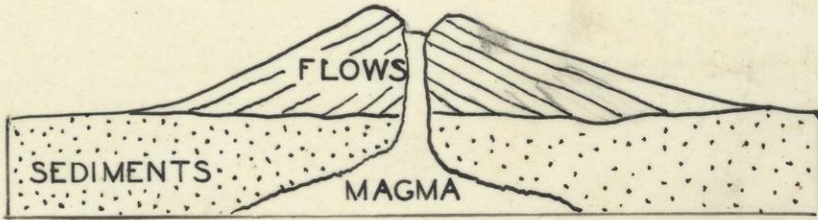

PUMICE ERUPTION

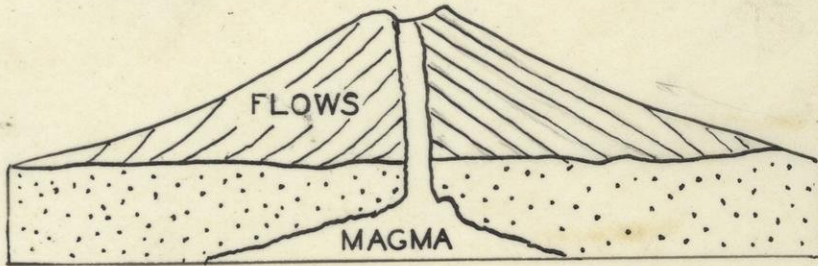

EXPLOSIVE ERUPTION

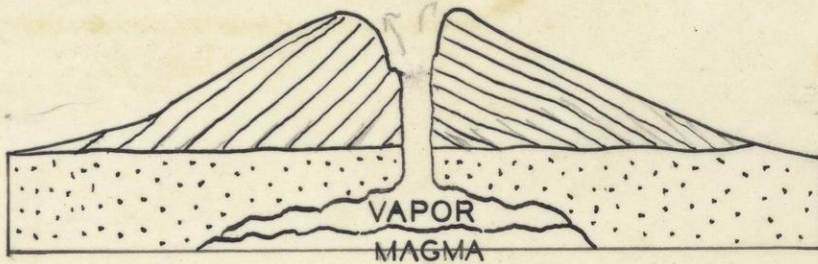

MAGMA FALLS

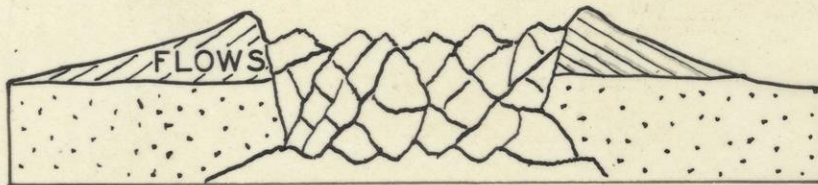

COLLAPSE

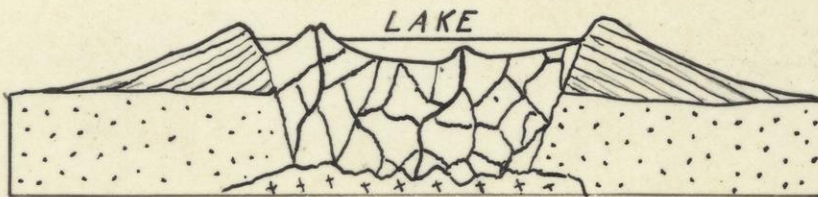

SMALL ERUPTIONS

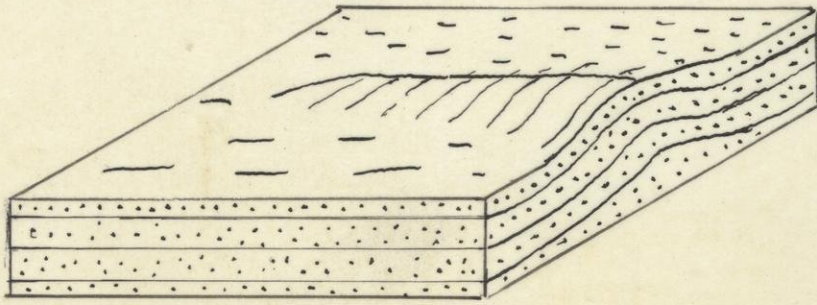

6.1

6-1

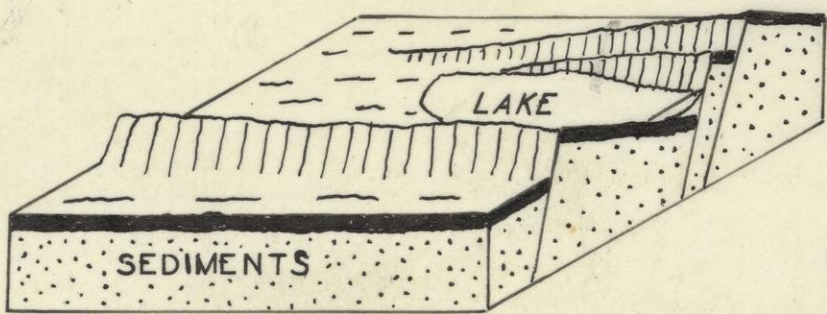

LAVA

6.2

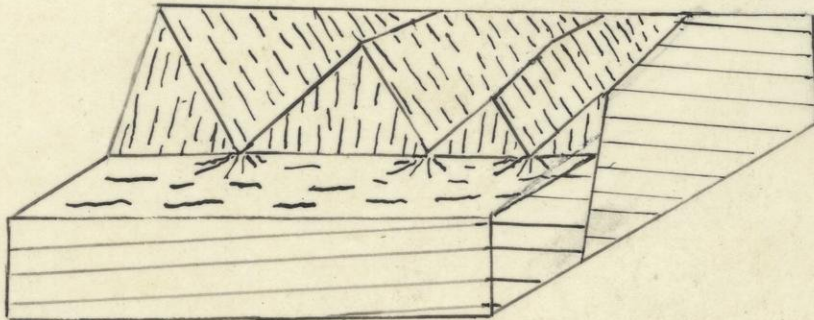

6.3

S

N

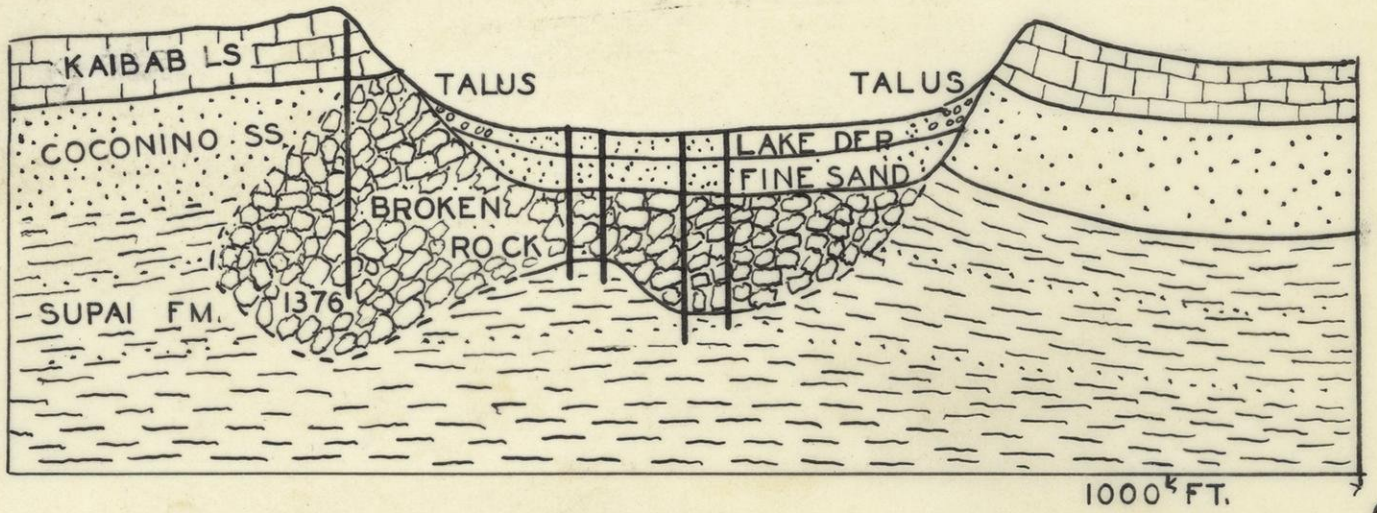

6.4

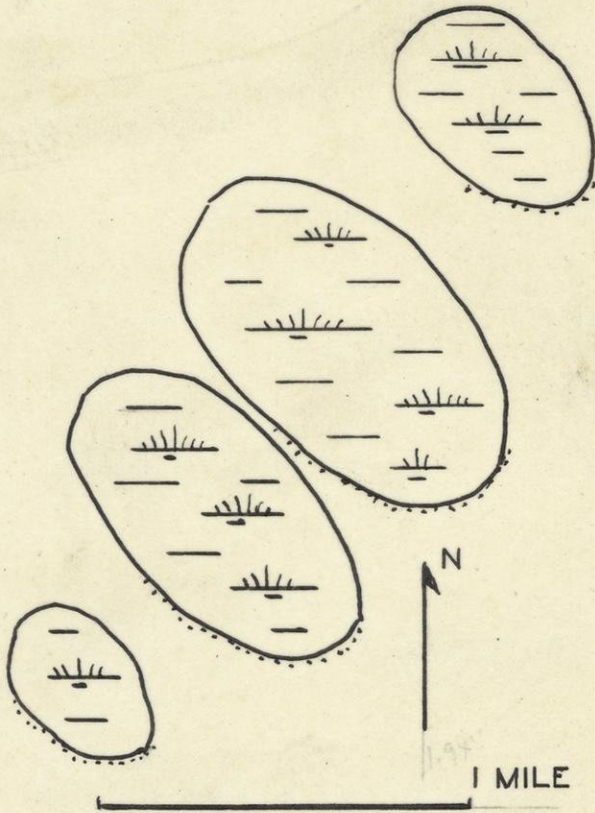

6.5

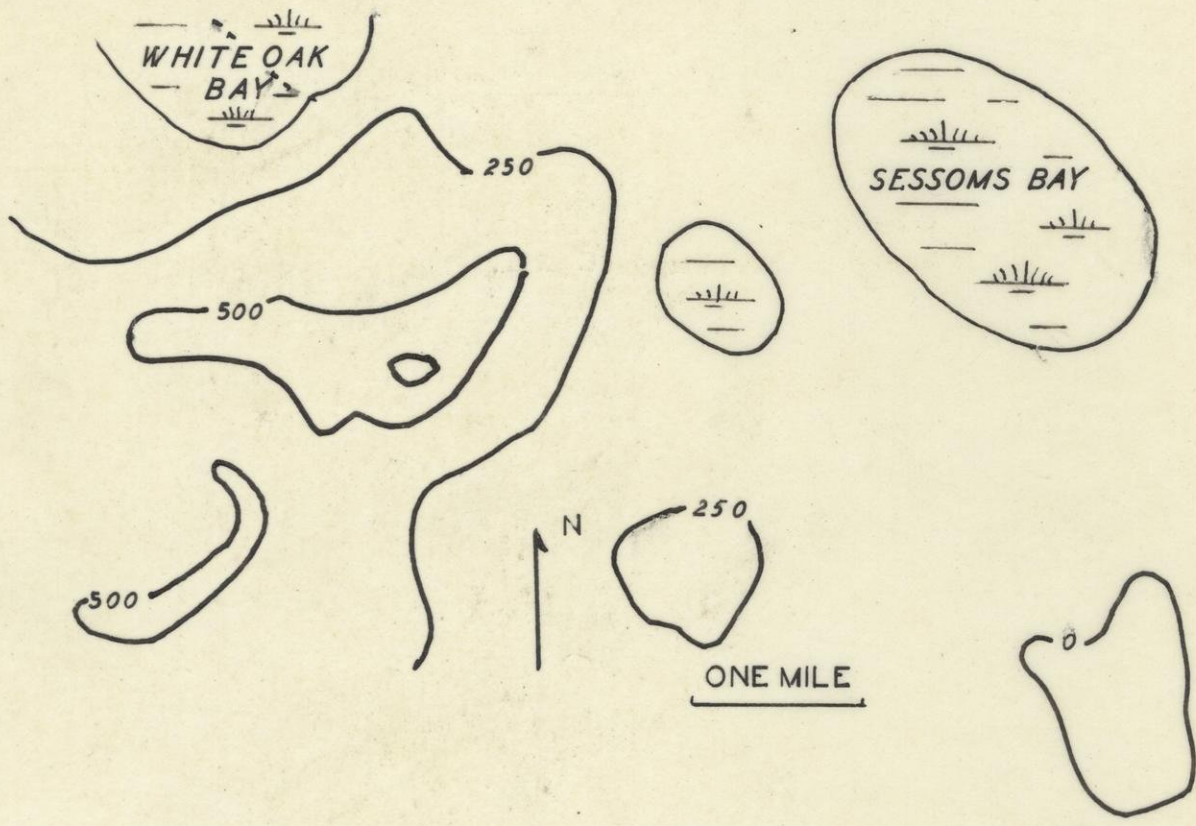

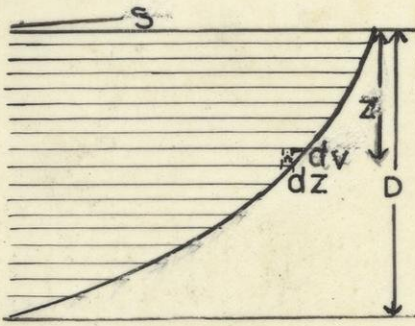

7.1

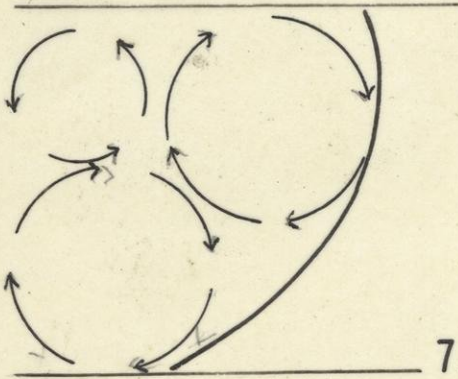

7.2

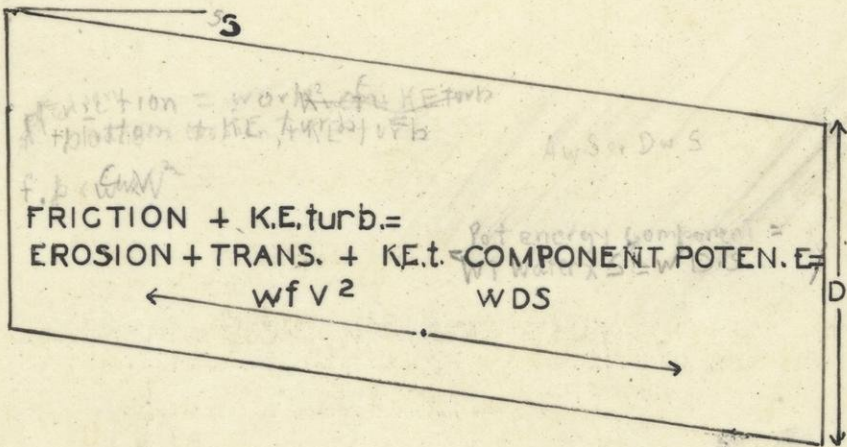

7.3

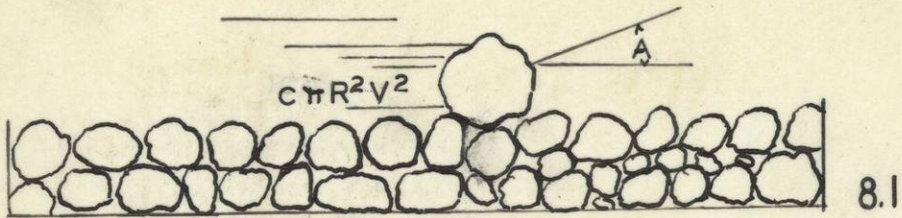

8.1

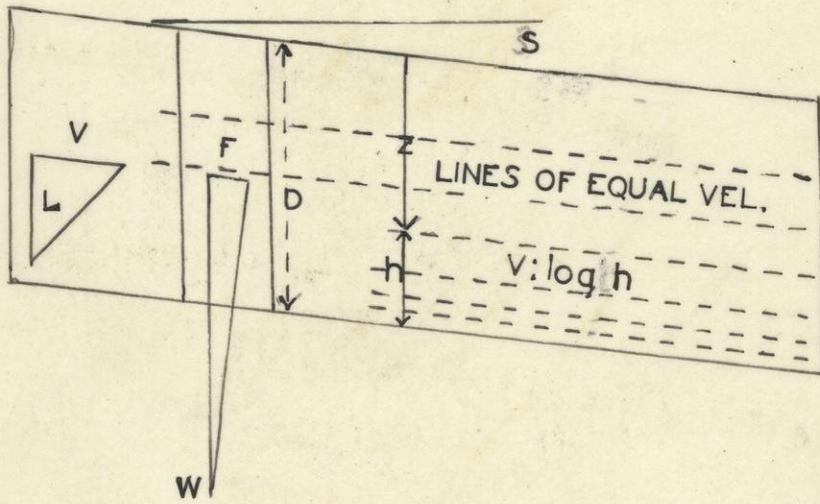

8.2

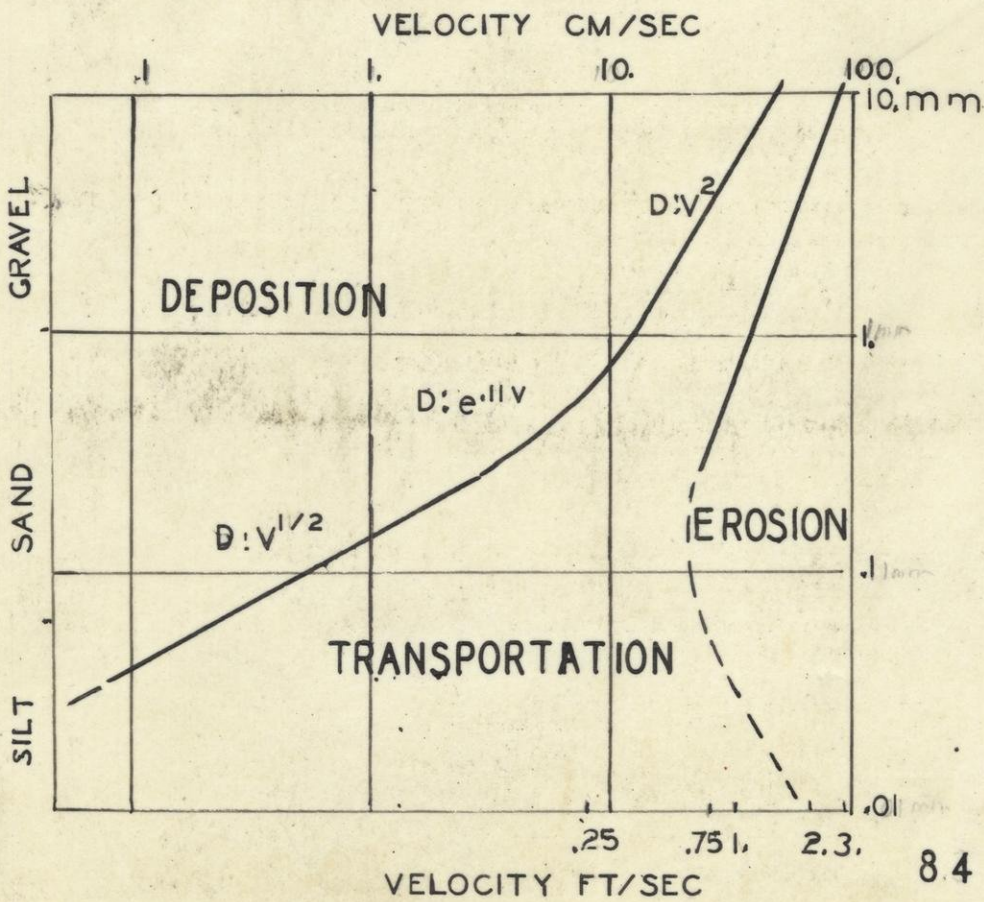

8.4

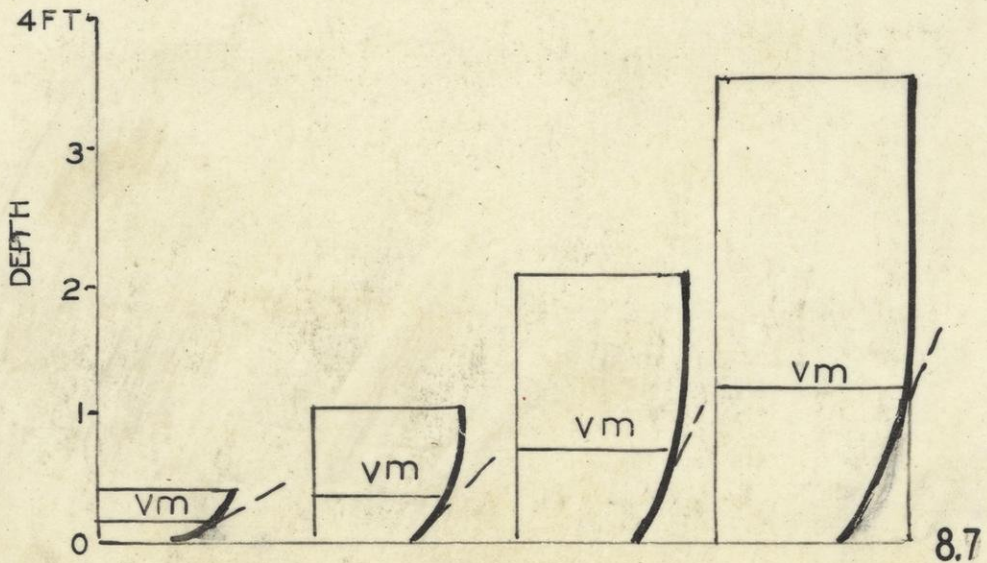
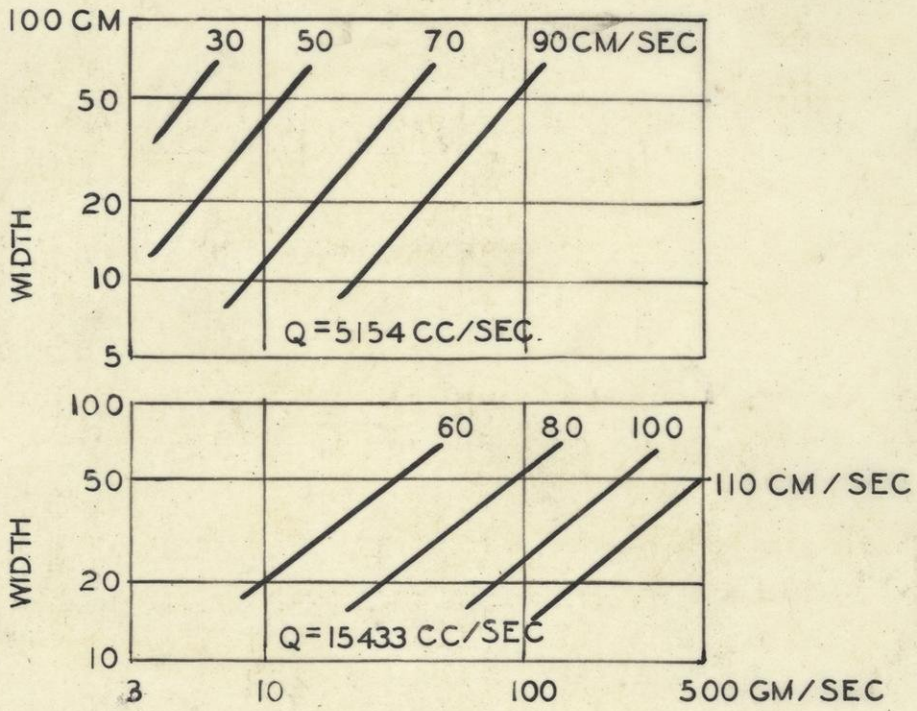
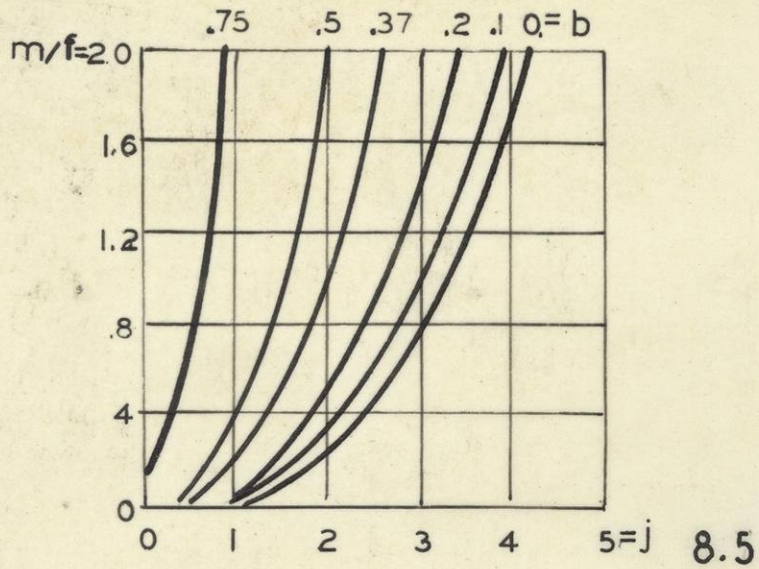

SUSPENDED SEDIMENT, TONS/DAY

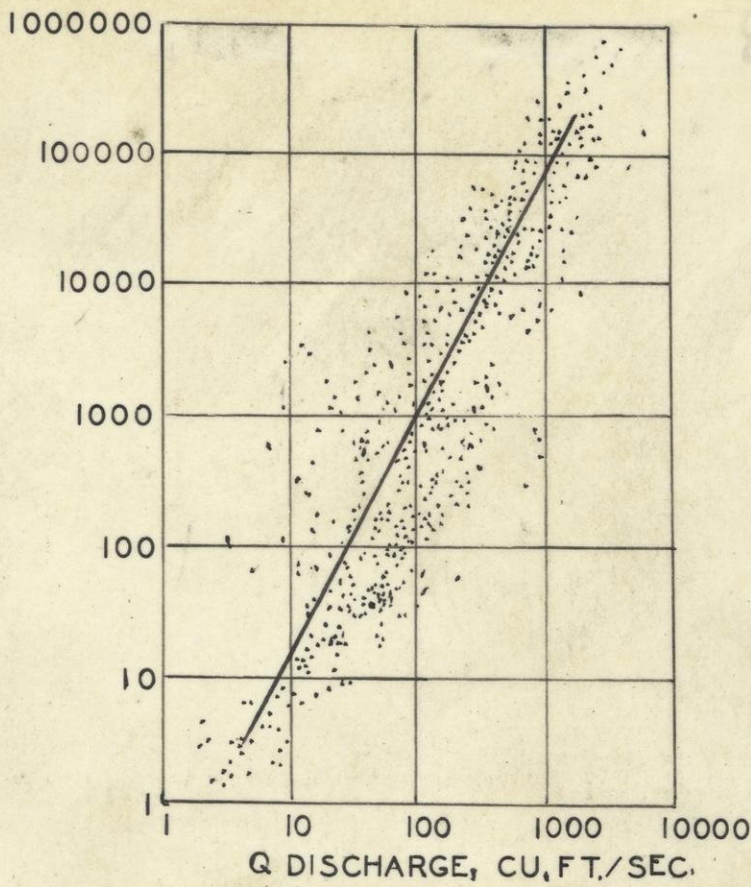

8.3

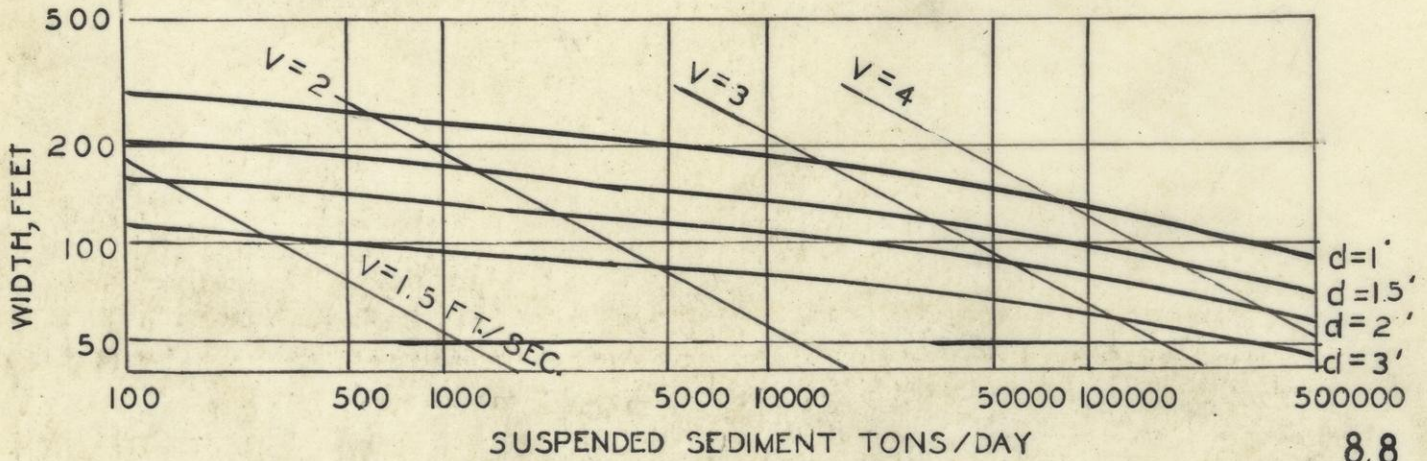

8.8

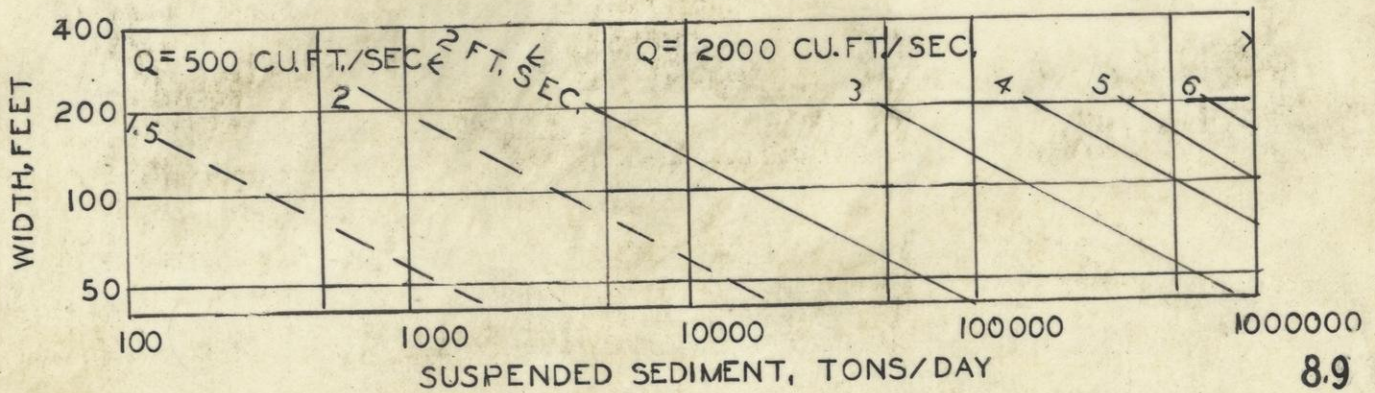

8.9

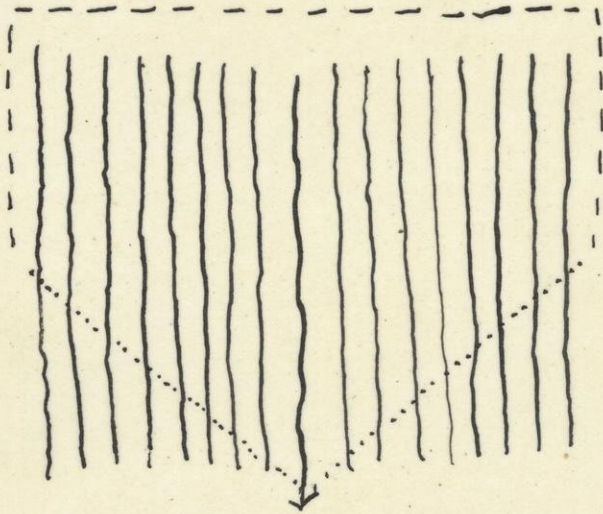

91

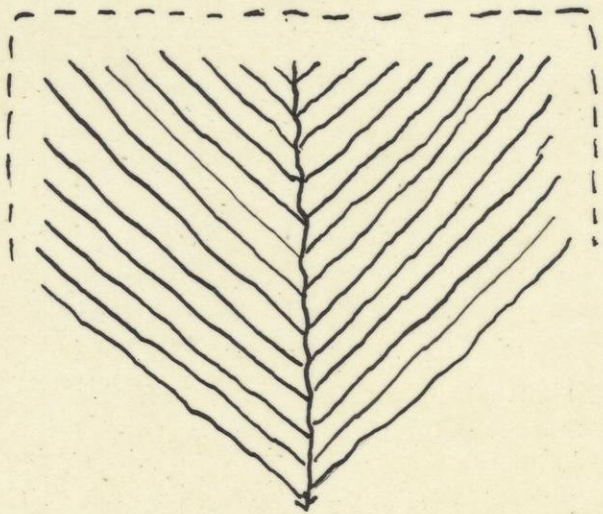

92

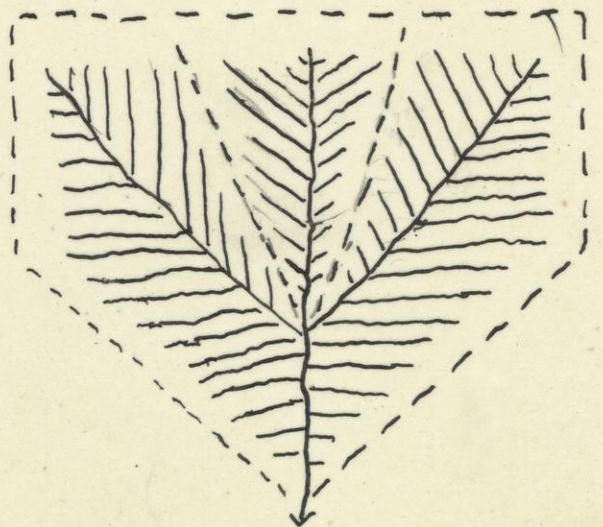

93

9-2

92

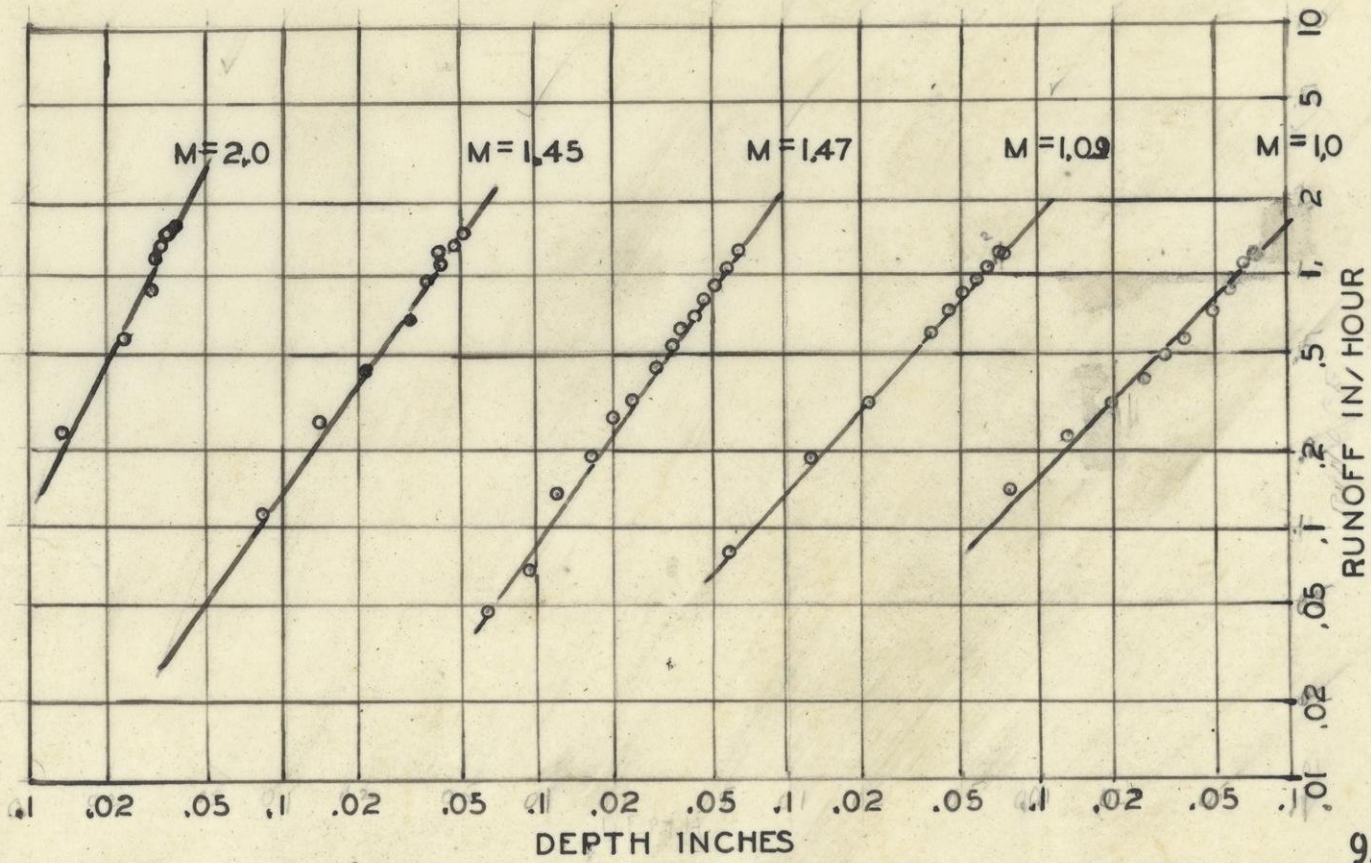

9.1

9.1

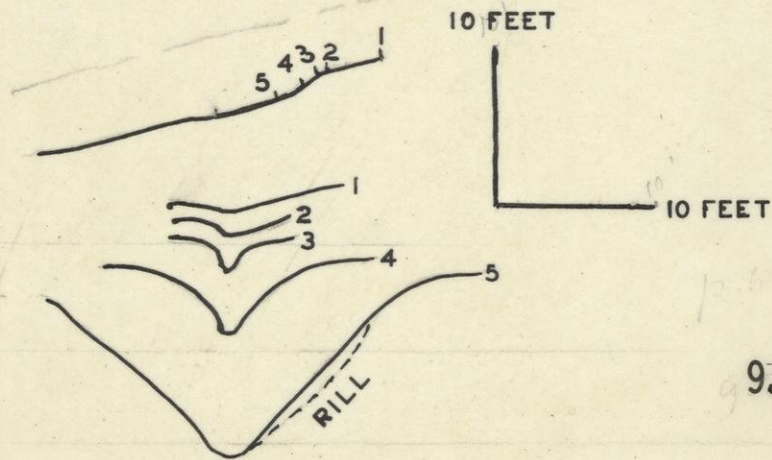

9.3

9.3

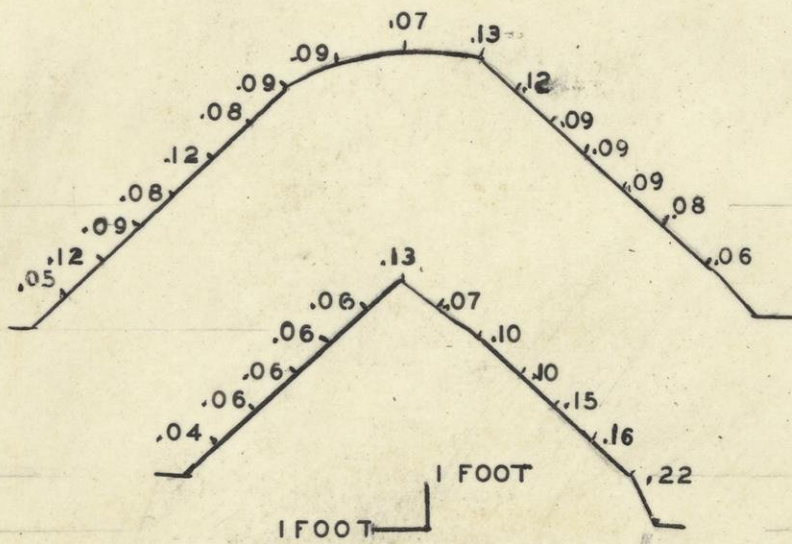

SLOPE EROSION IN 10 WEEKS, FEET

9.4

9.4

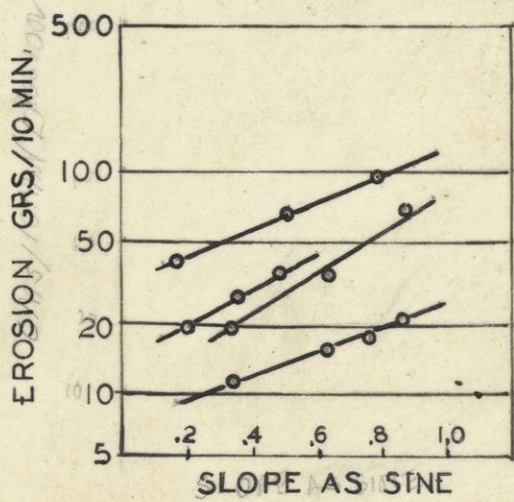

9.5

9.5

940
 900
 42 MILES FROM WISCONSIN DELLS
 1.62 FT./MILE W = 700 FT.
 ORIGINAL SURFACE
 RIVER
 55
 0.87 FT./MILE W = 480 FT.
 900
 960
 70

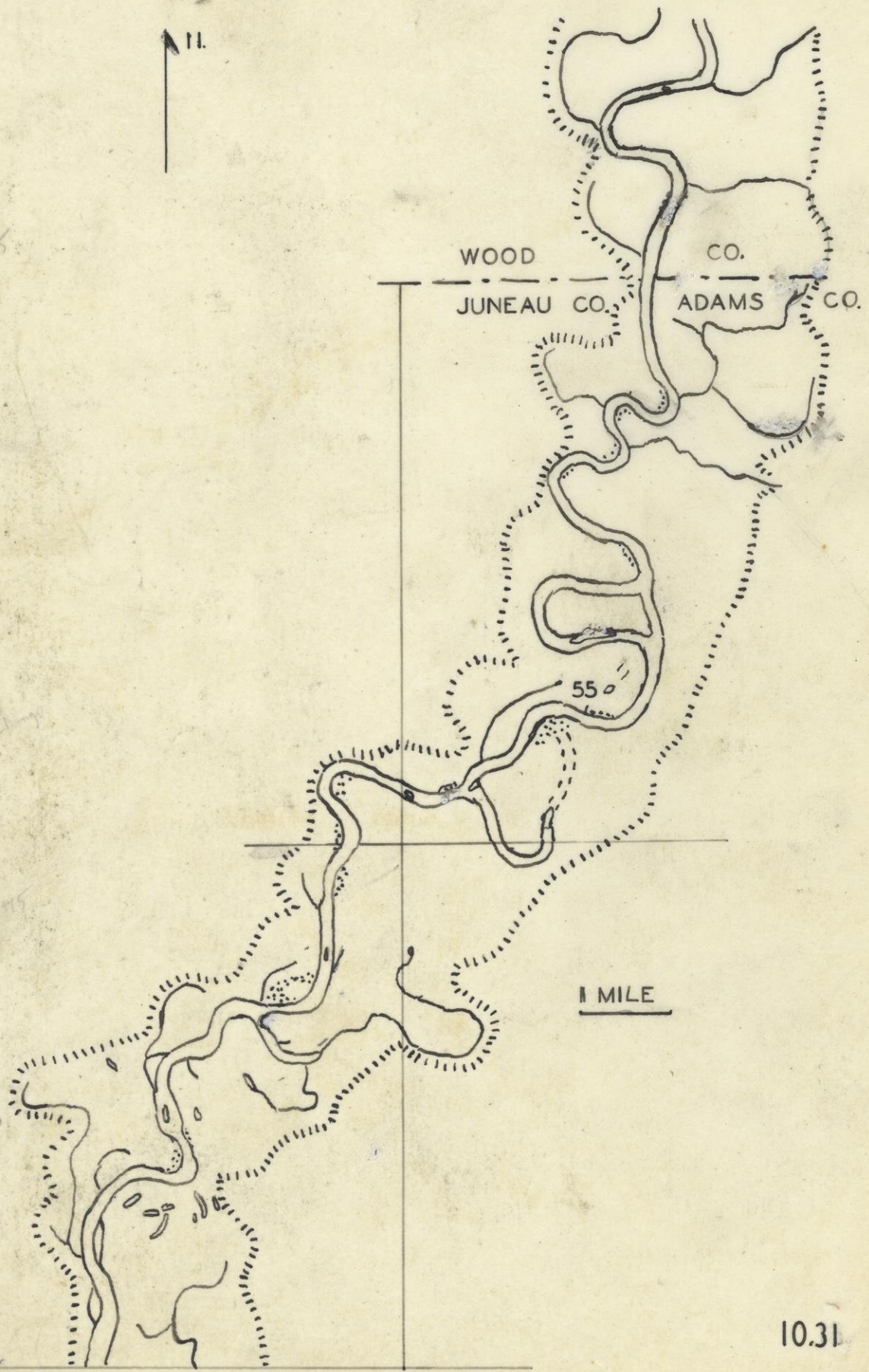
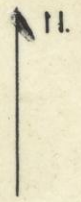

10.31

1031

10-18

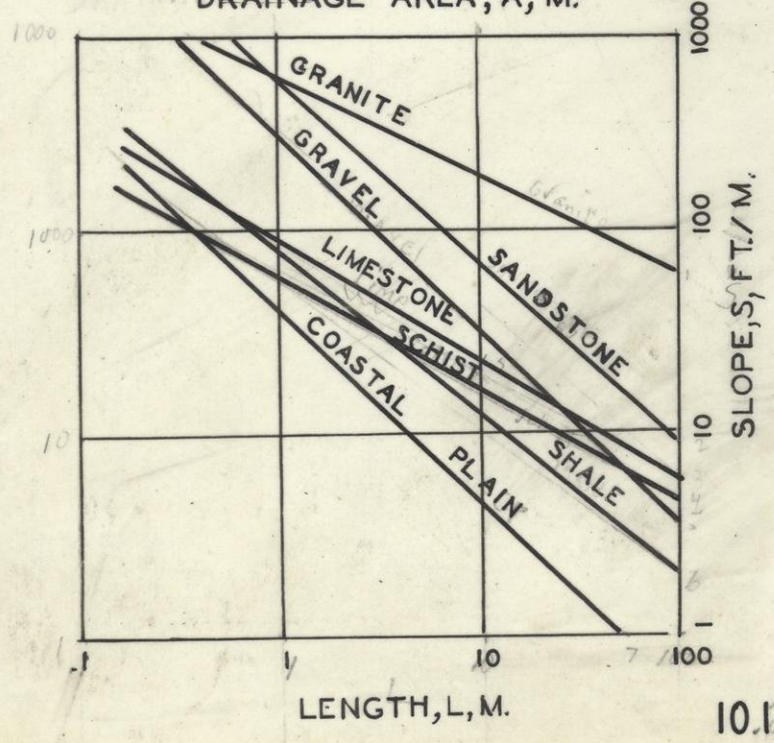
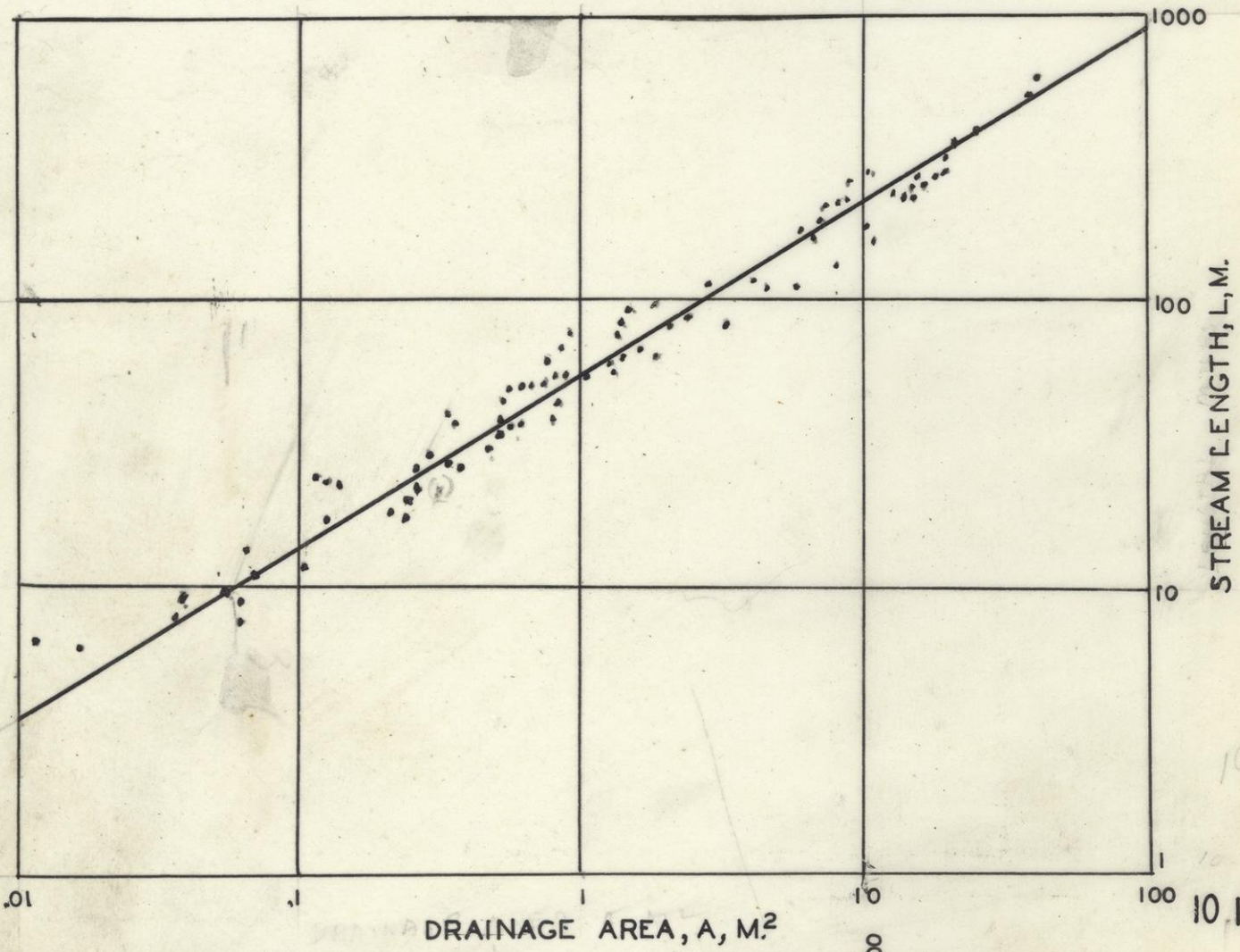

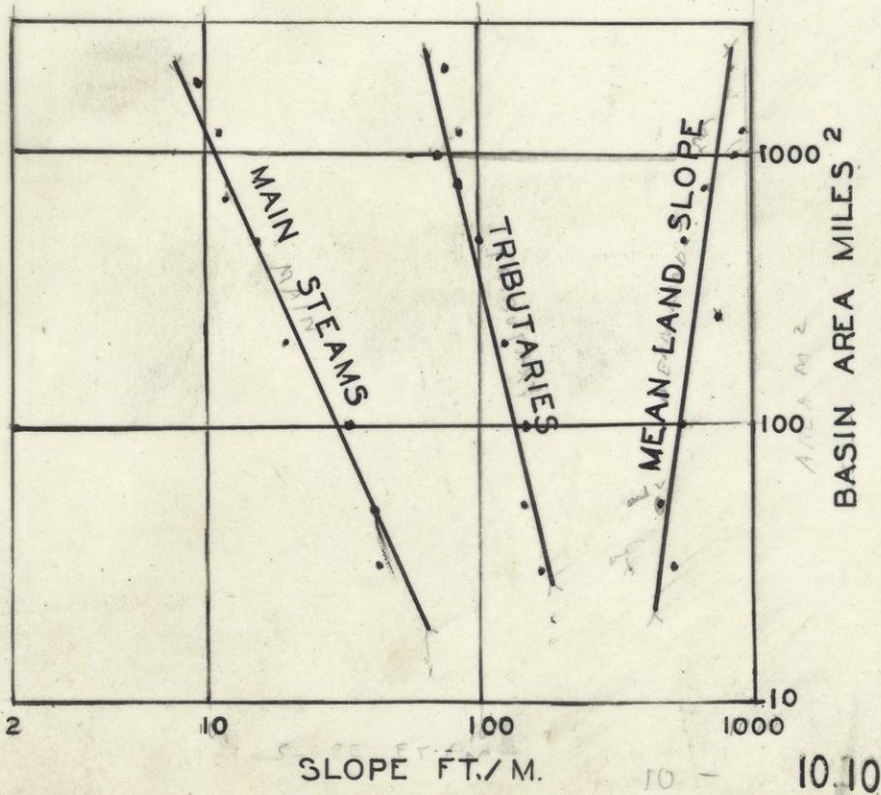

1010

10-29

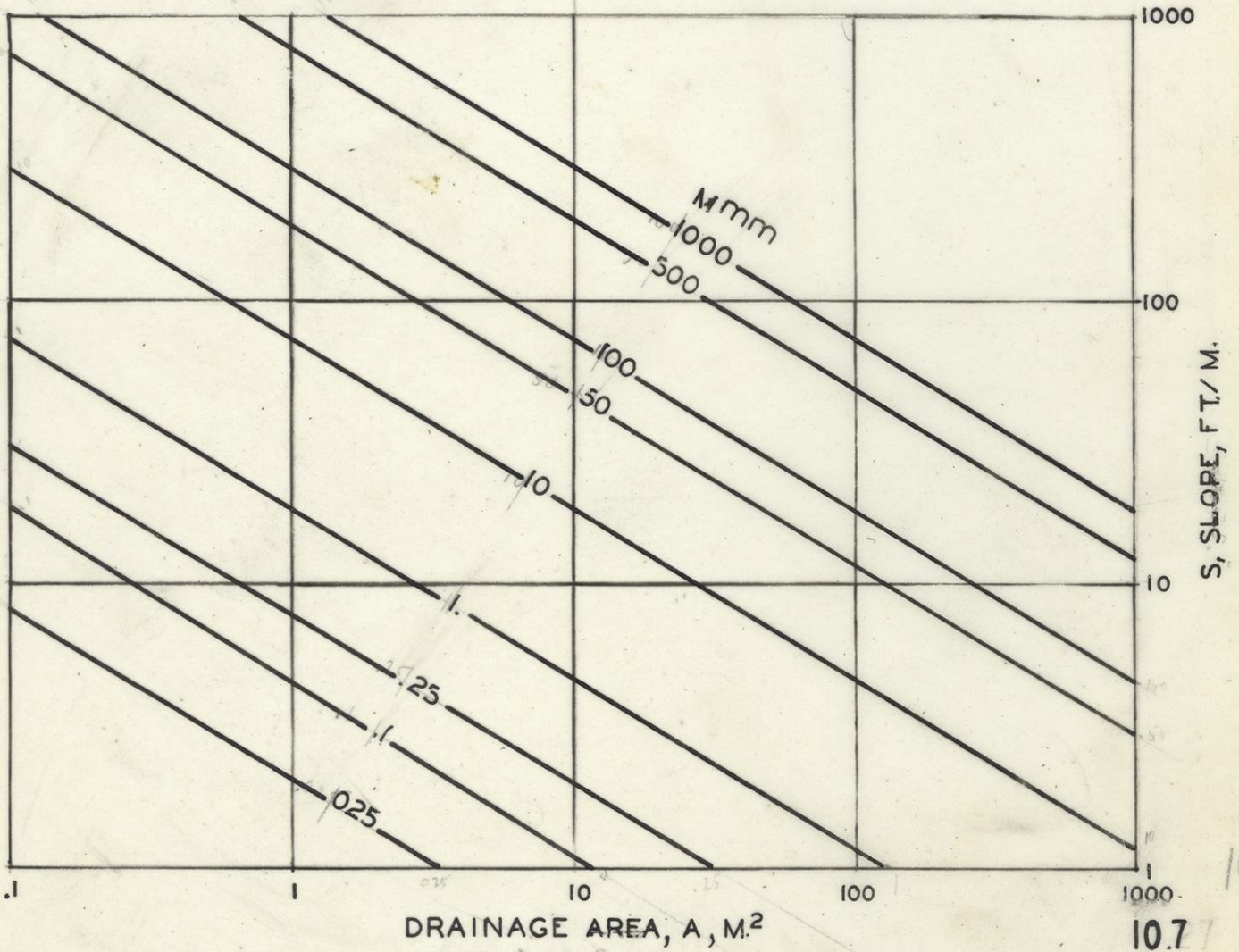

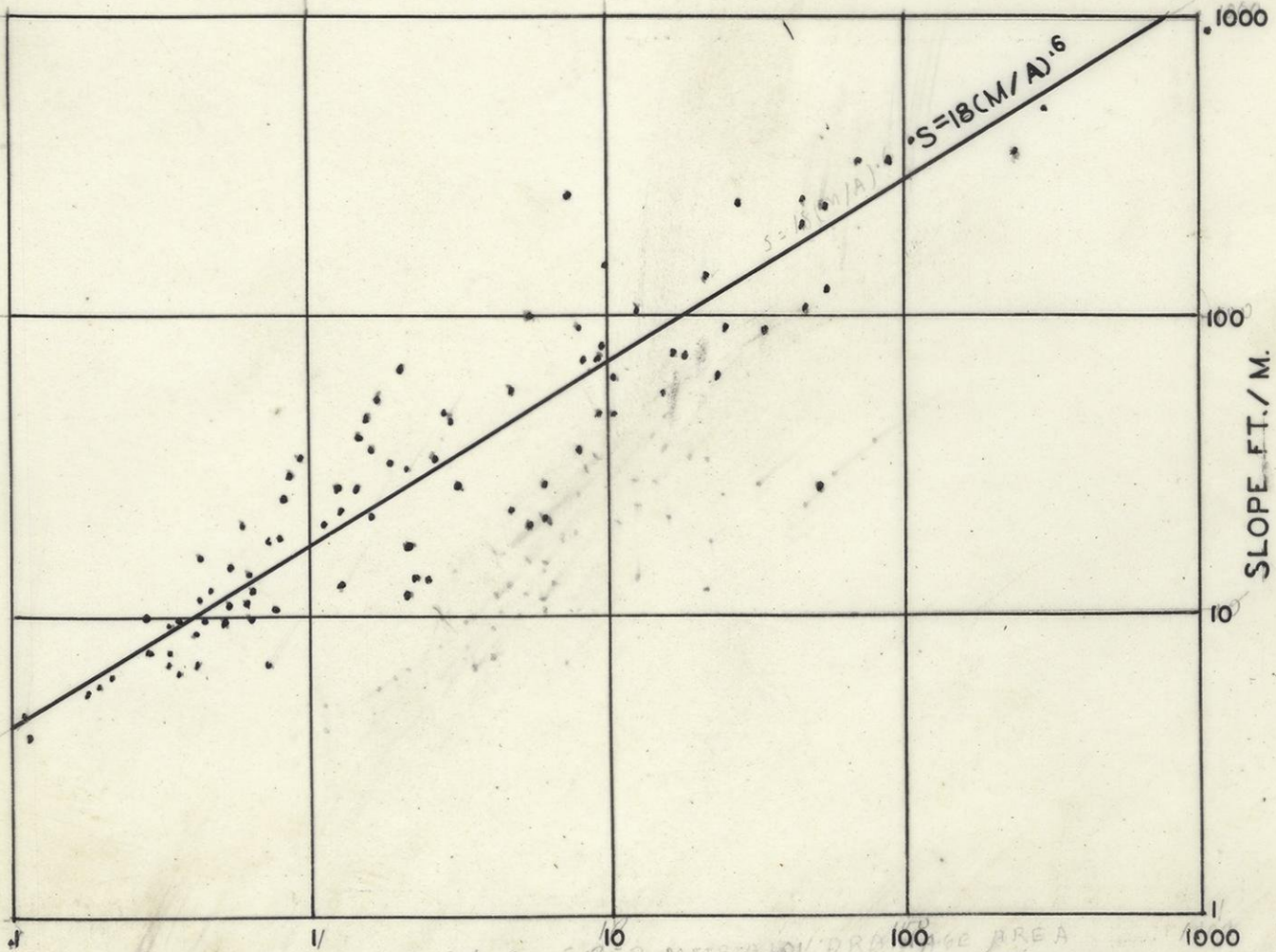

SLOPE FT/M

10.9?

10.9

RATIO OF MEDIAN SIZE OF BED MATERIAL, M, TO DRAINAGE AREA, A: 10.9

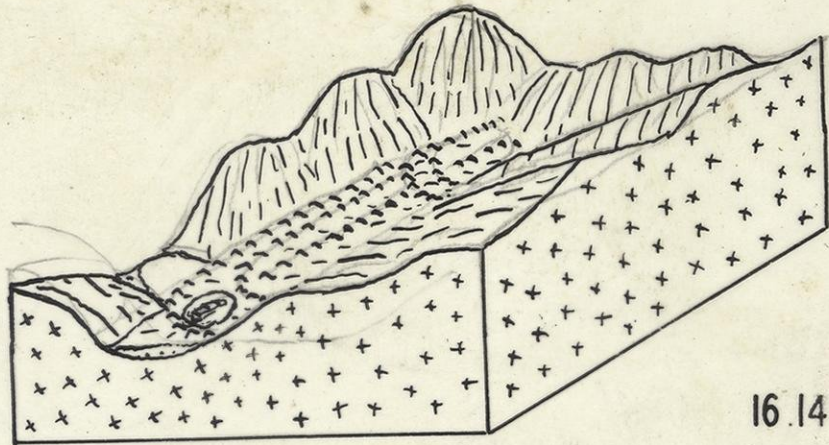

16.14

16.14

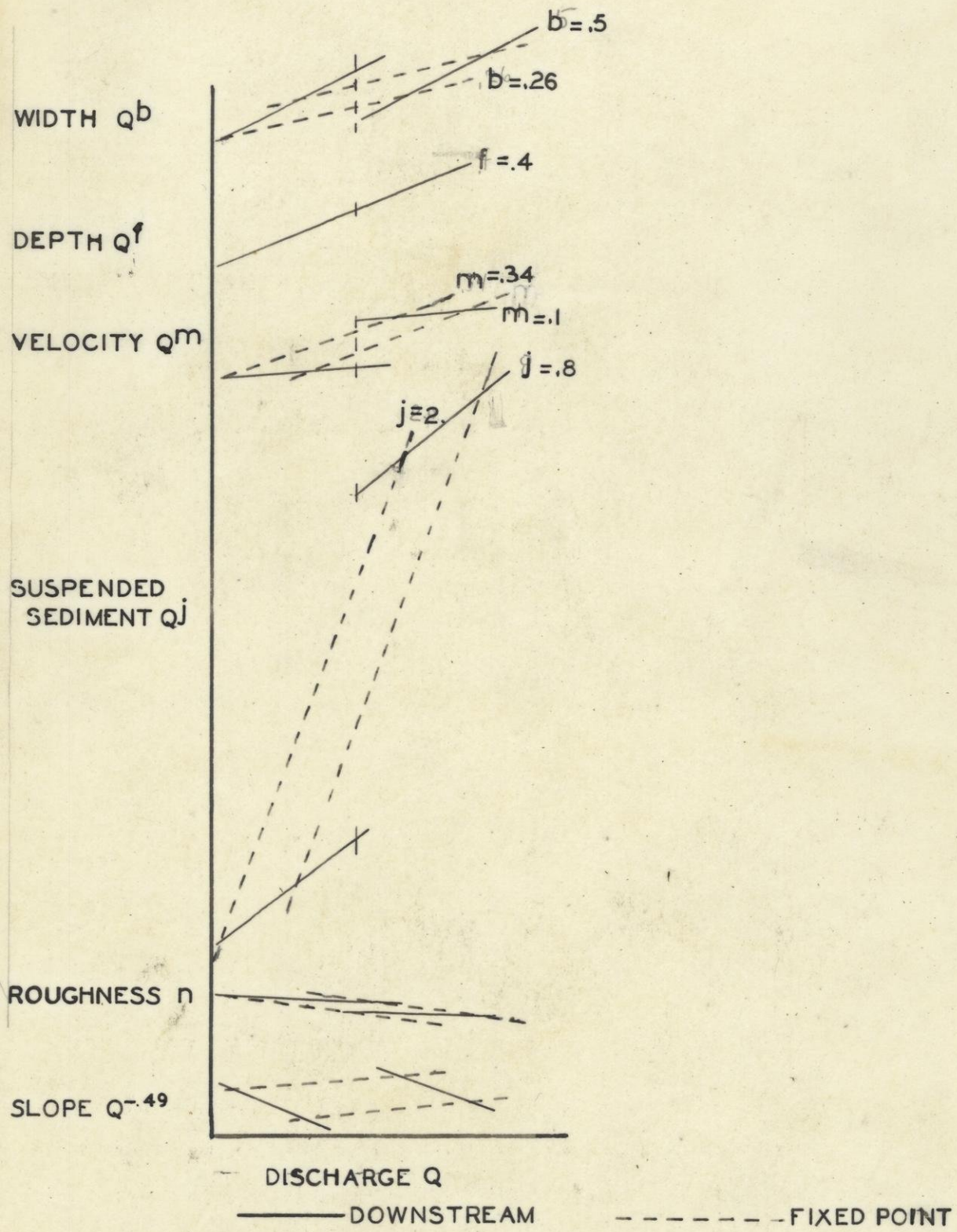

1021

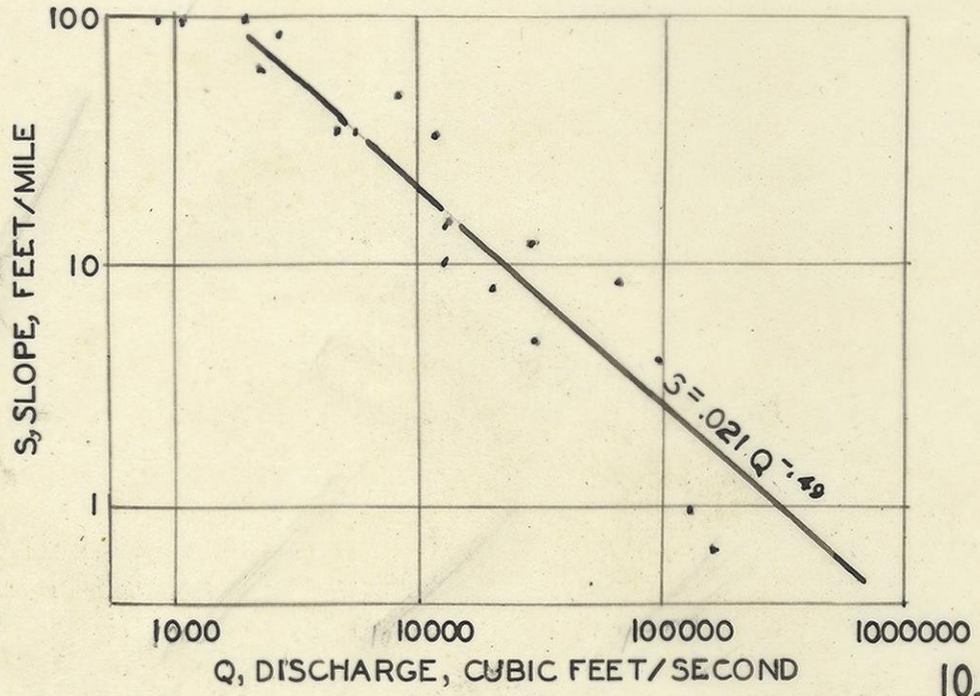

10.6

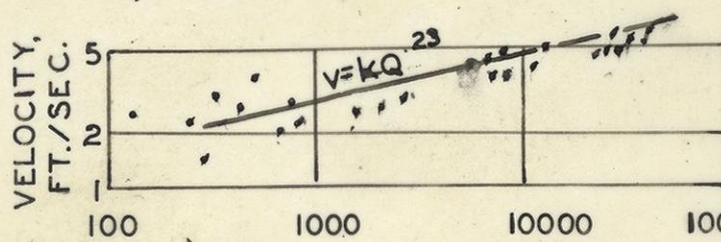
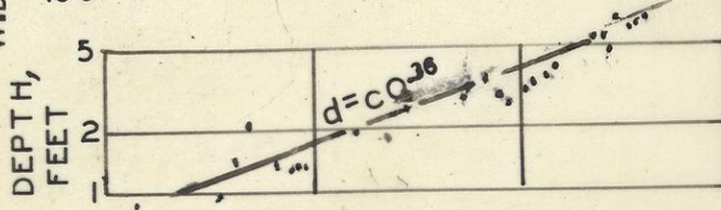
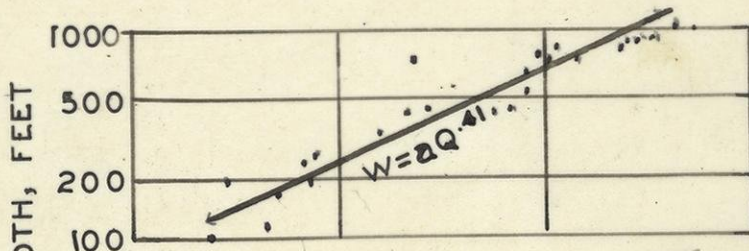

100 1000 10000 100000 CU FT/SEC.

1013

1013

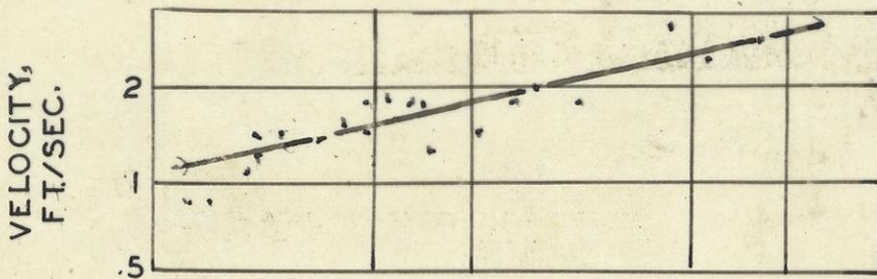
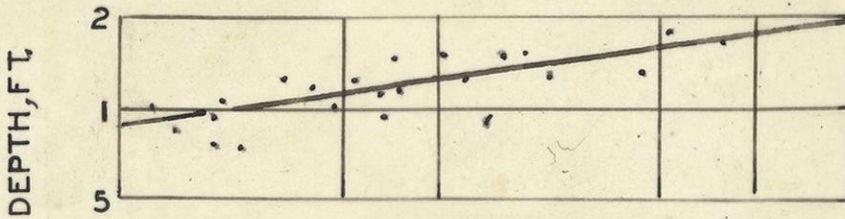
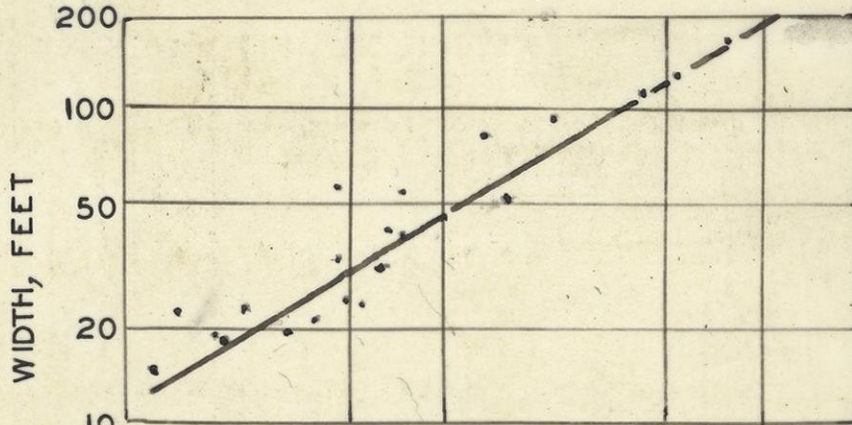

10 50 100 500 1000 MEAN ANNUAL DISCHARGE CU.FT./SEC.

10.14

10.14

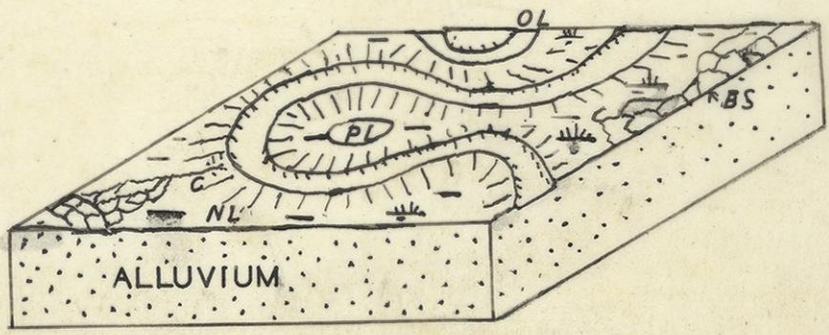

10.28 1028

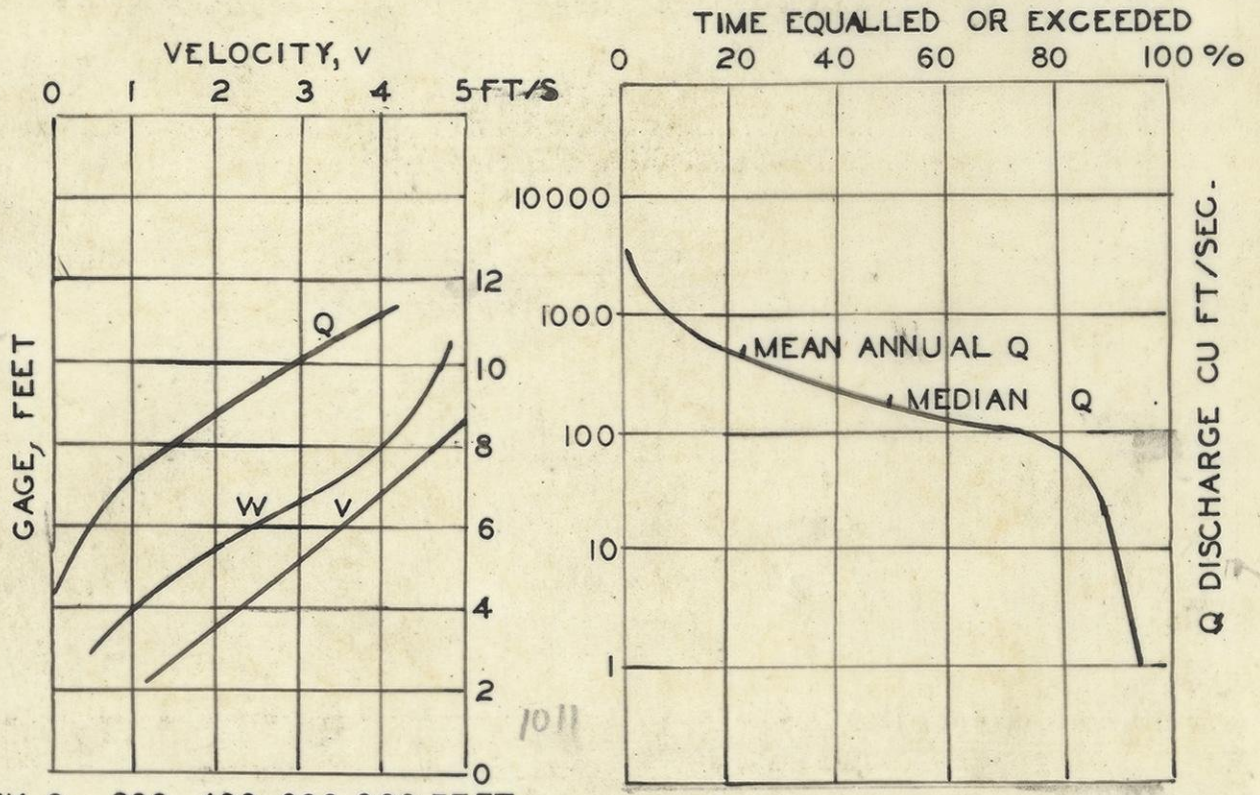

W, WIDTH 0 200 400 600 800 FEET
 Q, DISCHARGE 0 10000 20000 30000 40000 CU. FT/SEC.

10.11

10.12

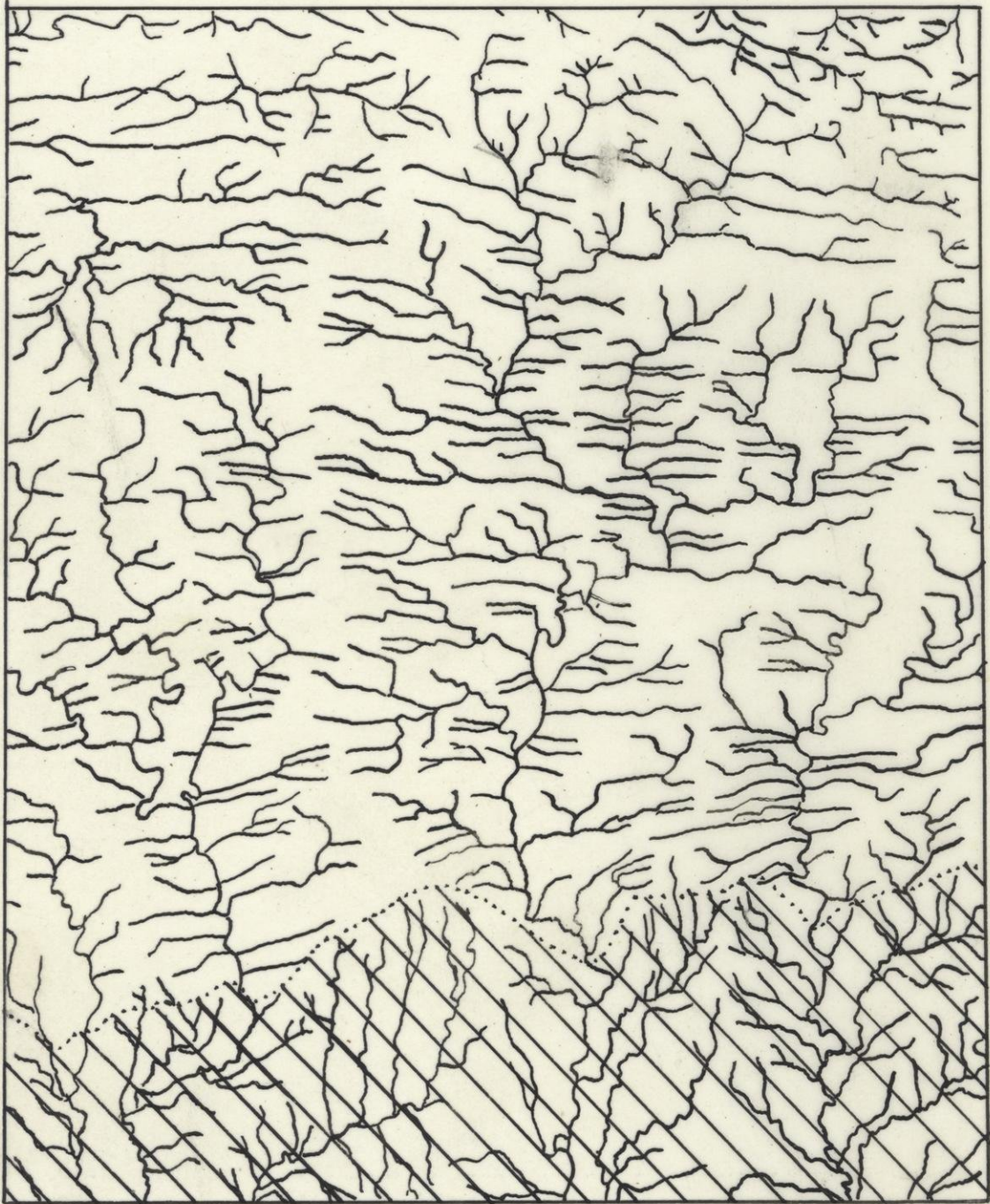

N

5 M.

10.20

10-20

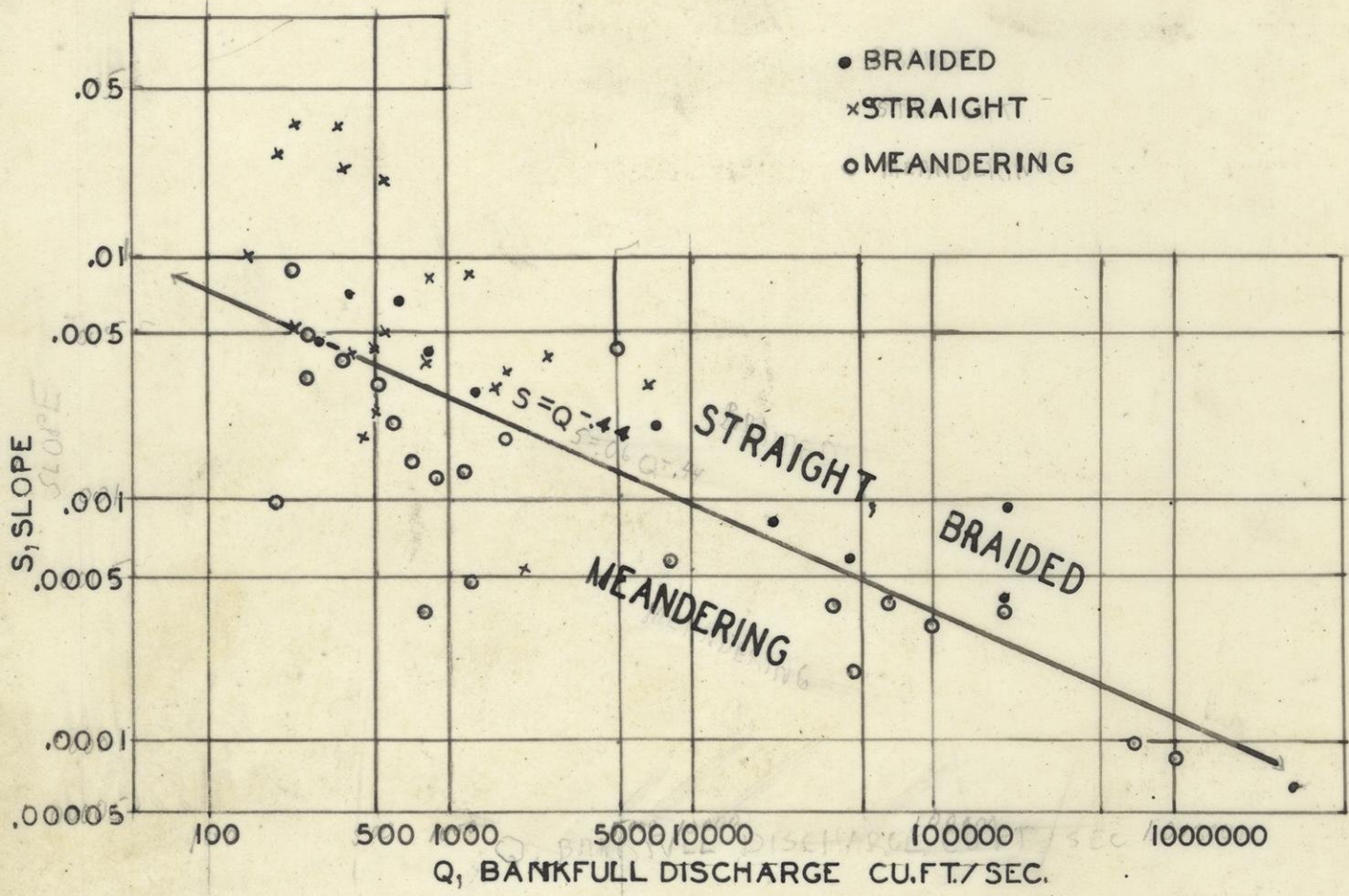

10.24

10.24

Q, BANKFULL DISCHARGE, CU.FT./SEC.

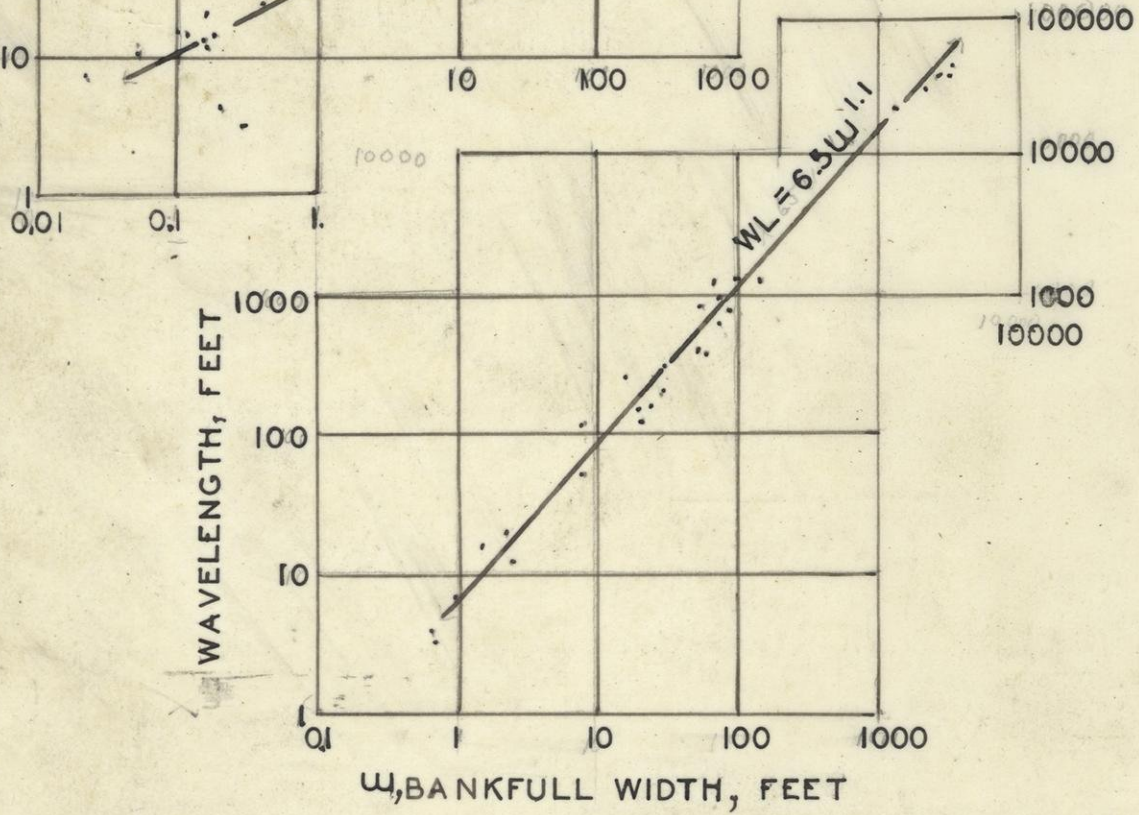
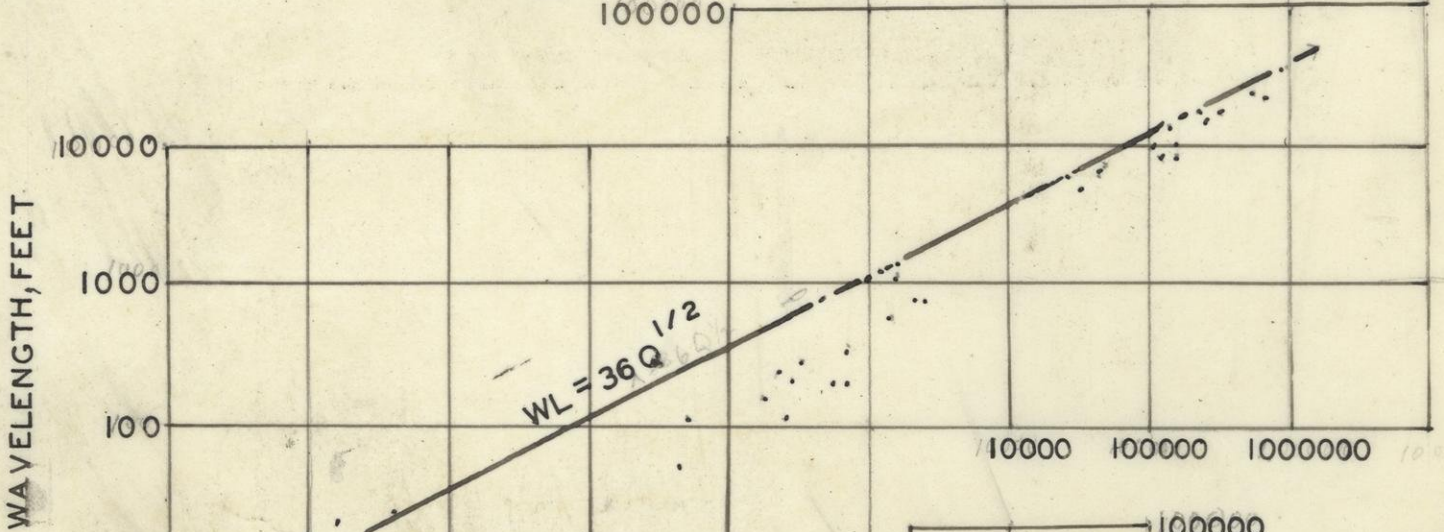

1025

10.25

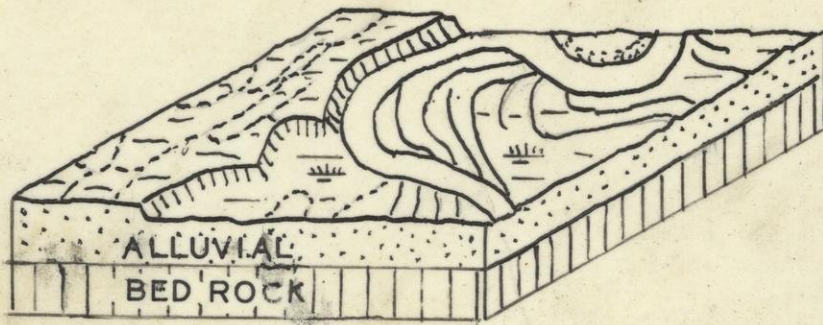

10.22

1022

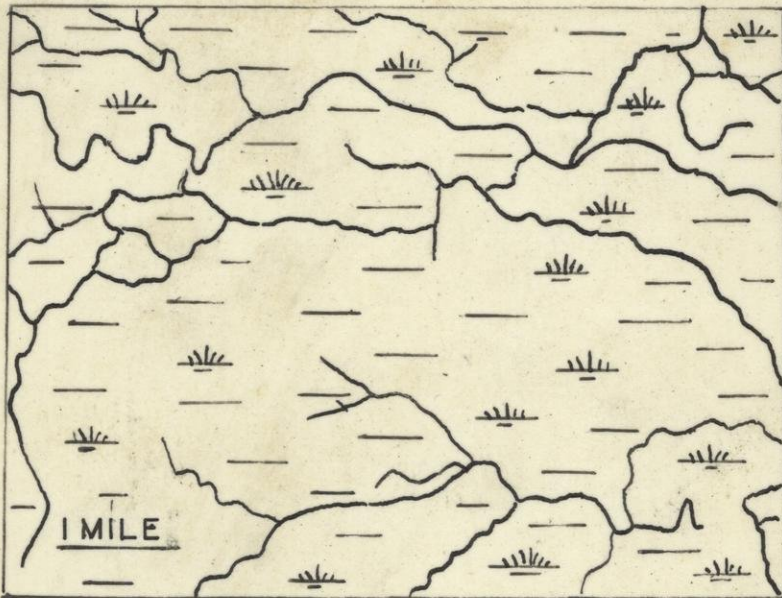

10.19

1019

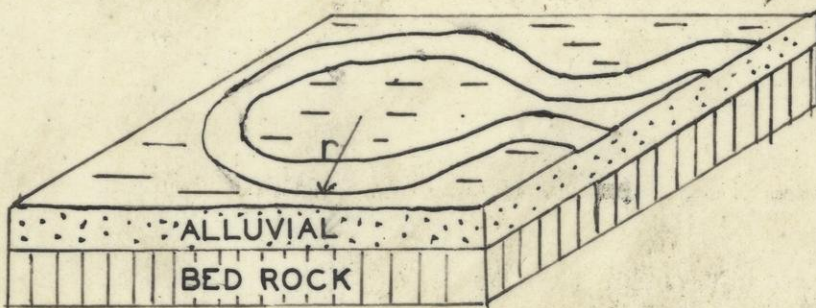

10.23

1023

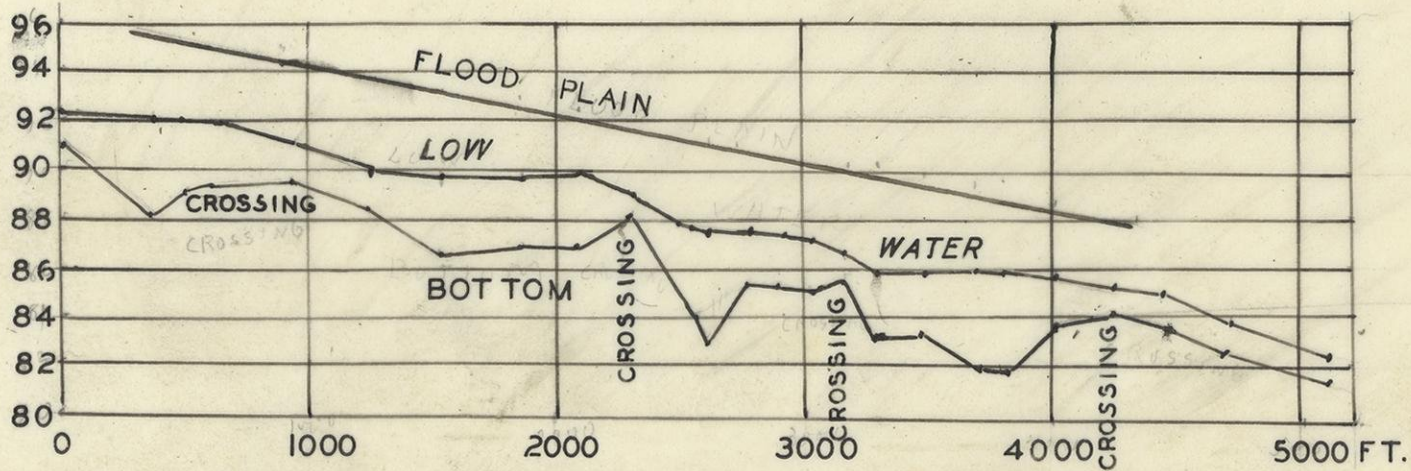
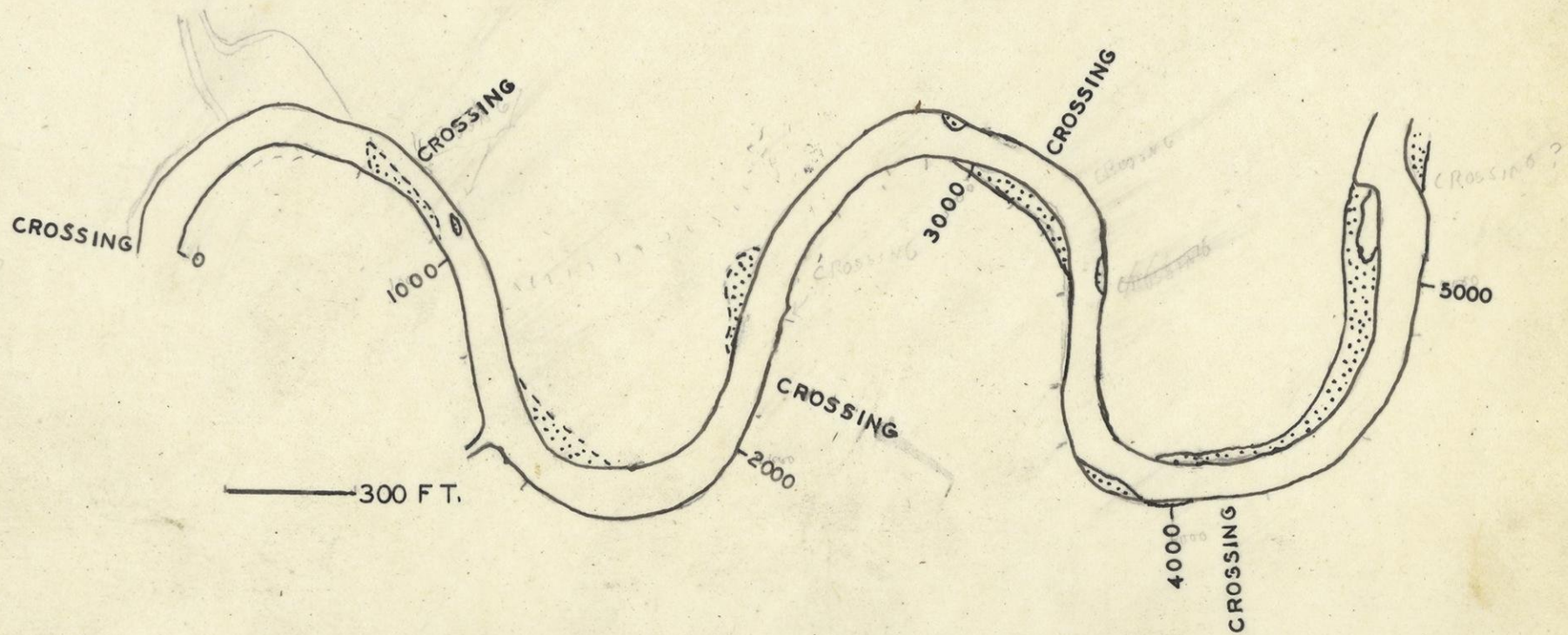

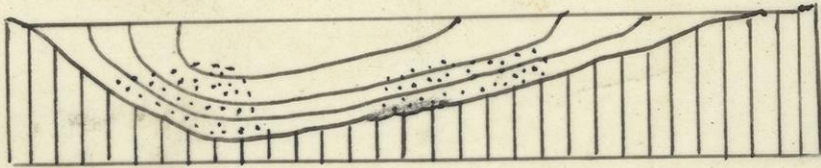
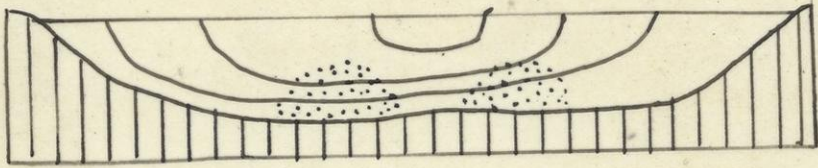

10.29

1029

10-13

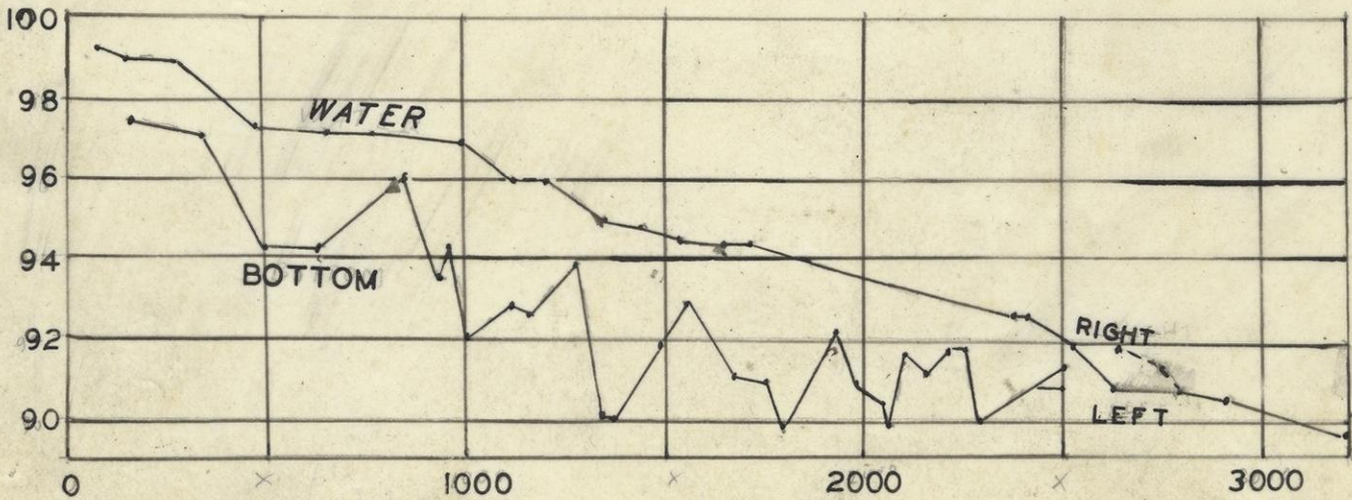
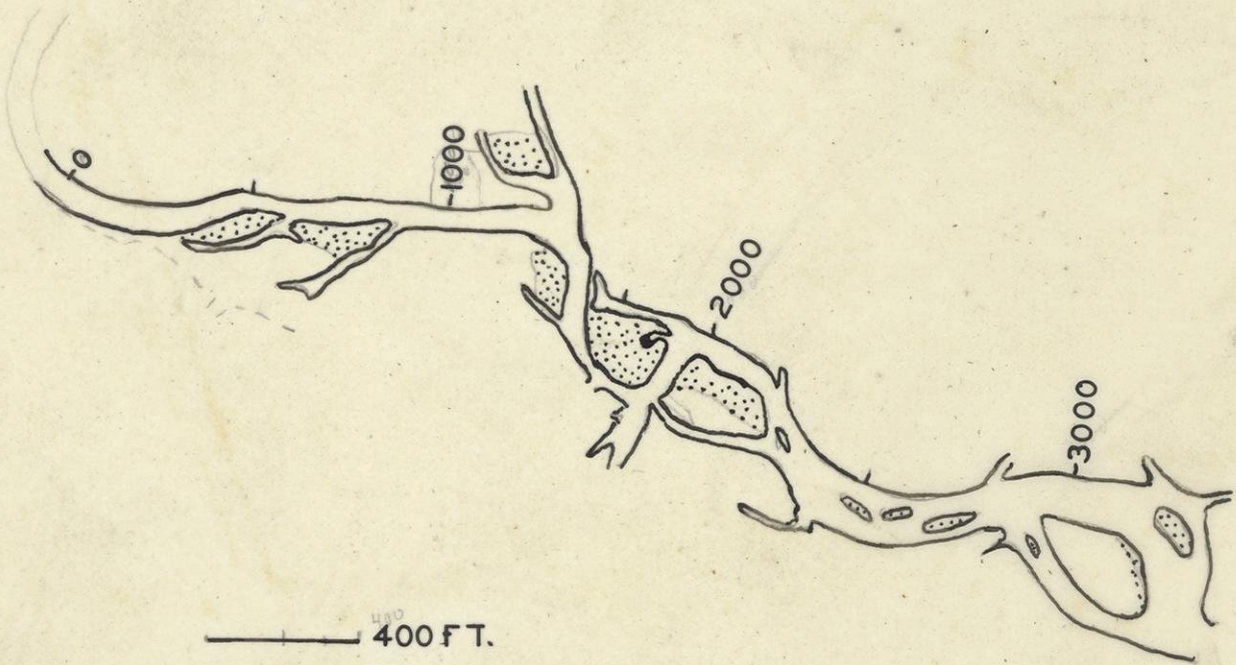

1026

10.26

10-14

W?
?

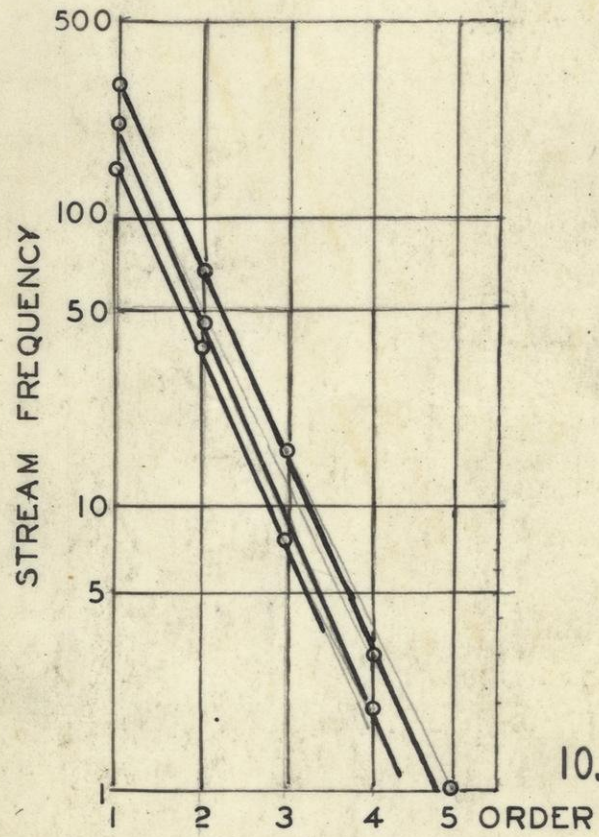

10.4

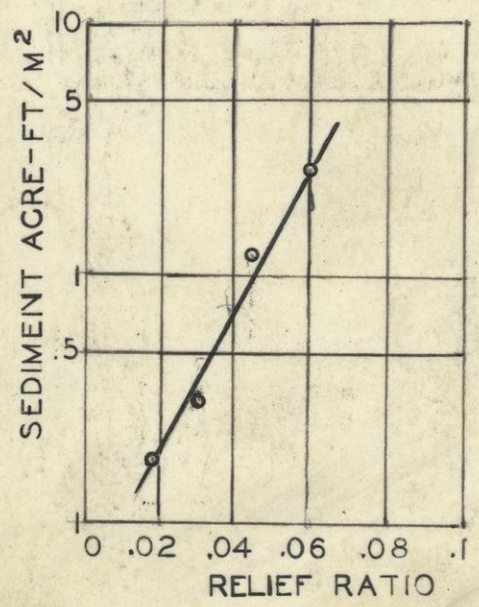

10.30

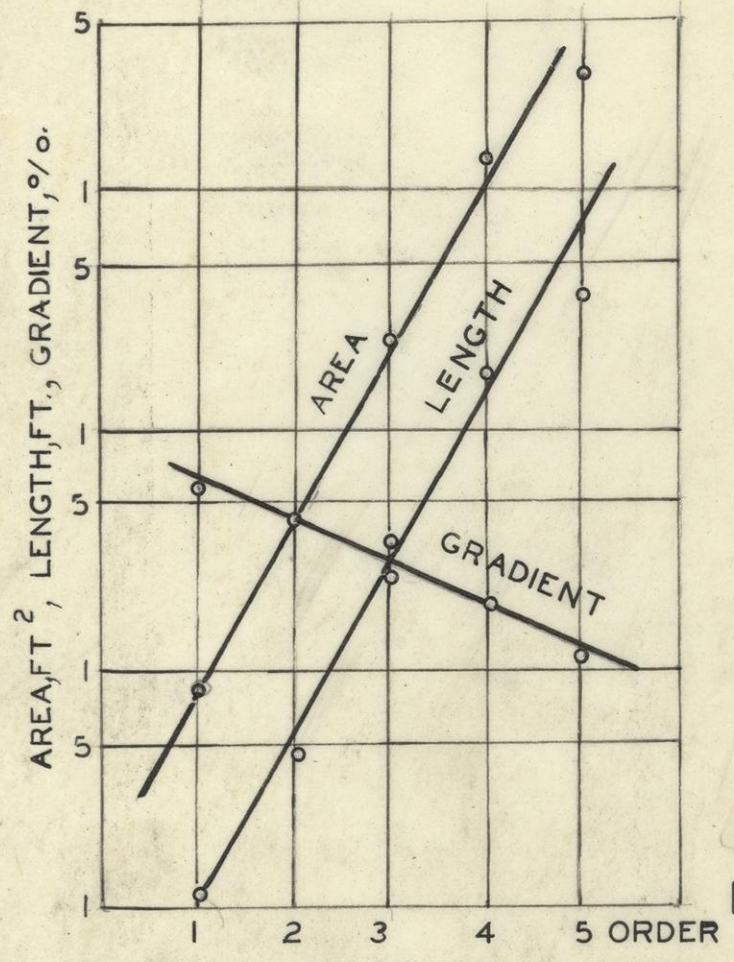

10.5

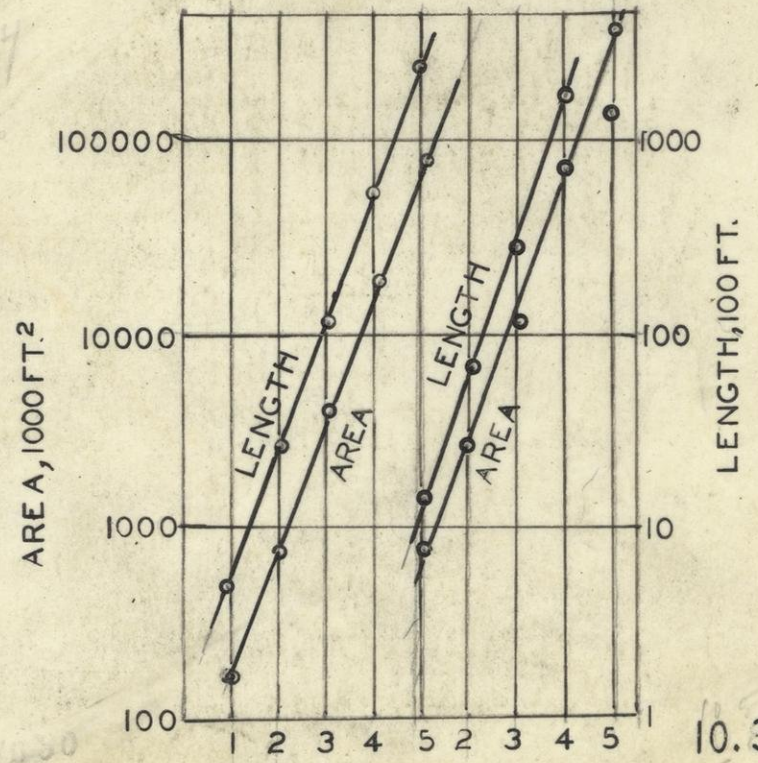

10.3

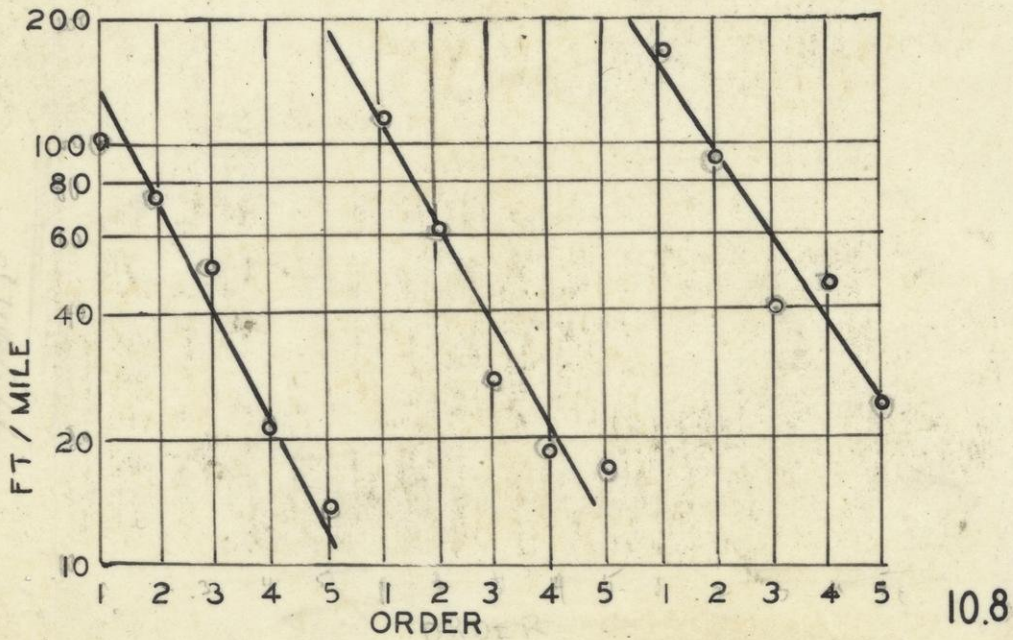
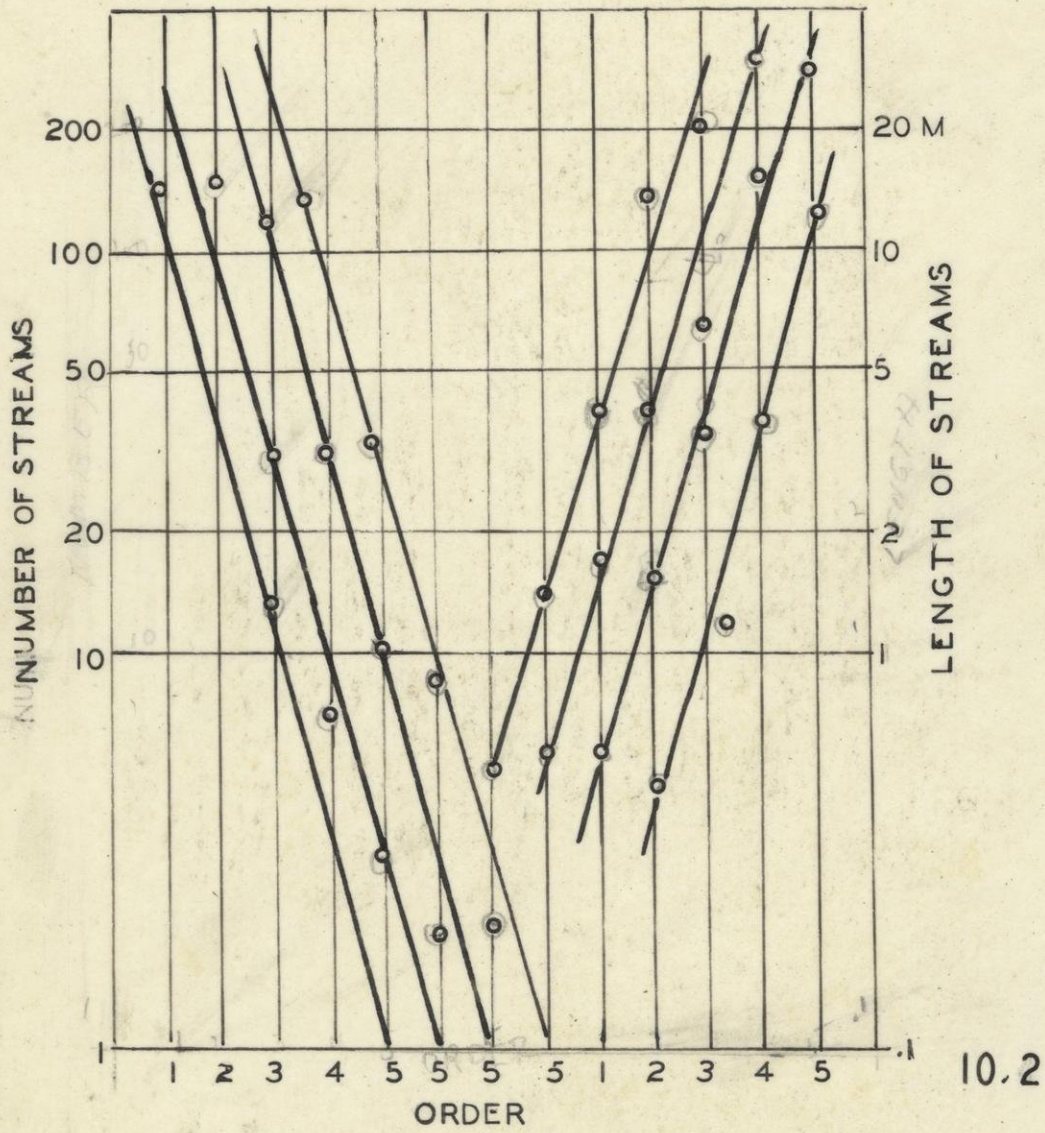

10.8

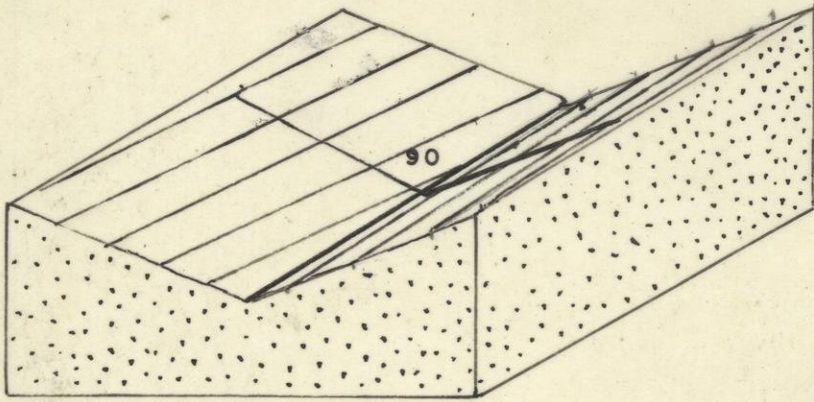

10.17

10.17

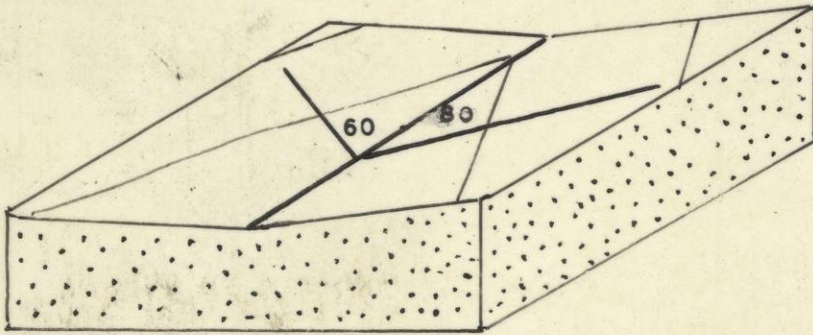

10.18

10.18

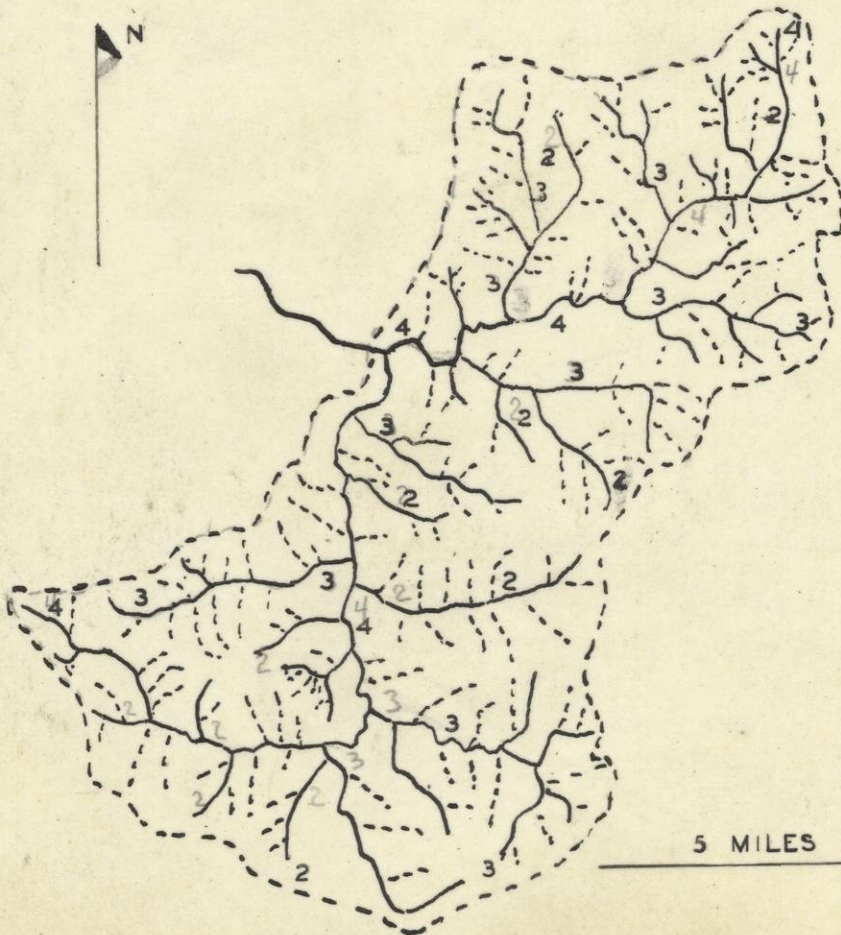

10.1

10.1

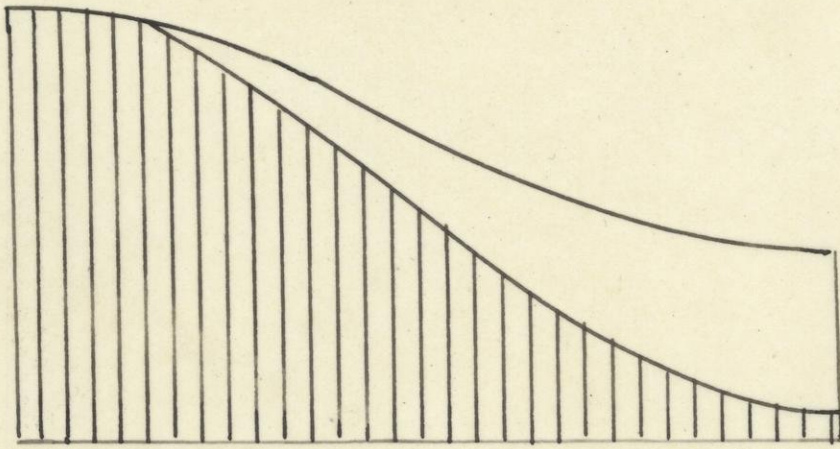

11.1

11-1

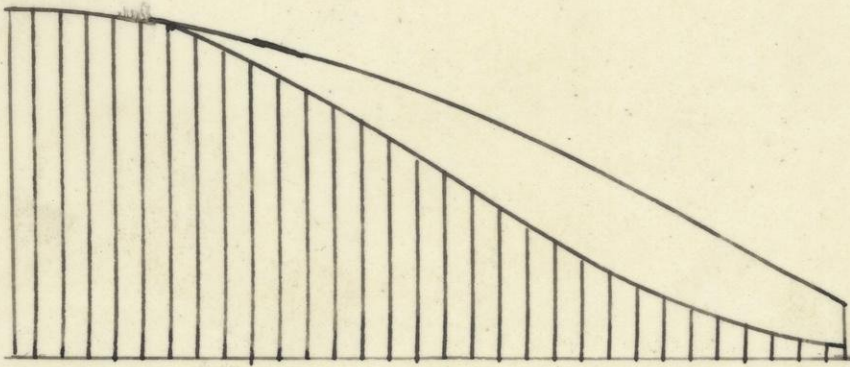

11.2

11-2

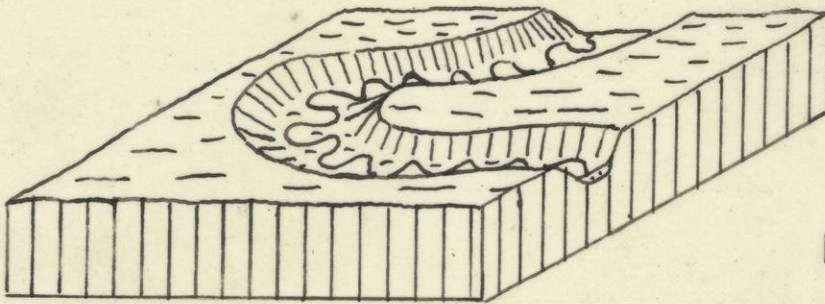

11.6

113
116 on

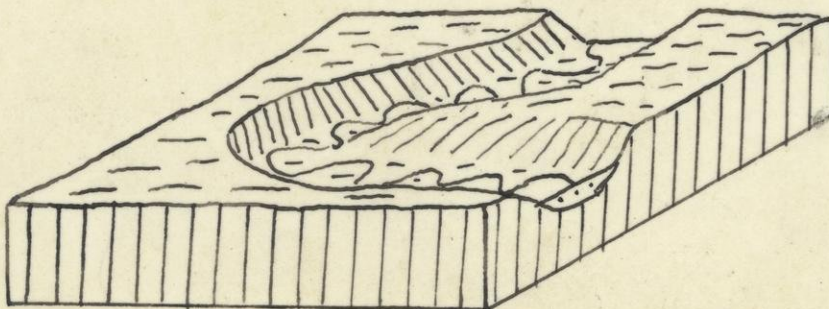

11.7

11.7

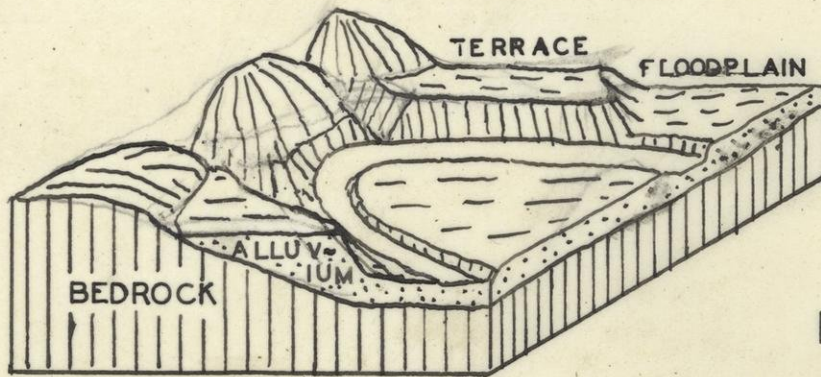

11.8

11.8

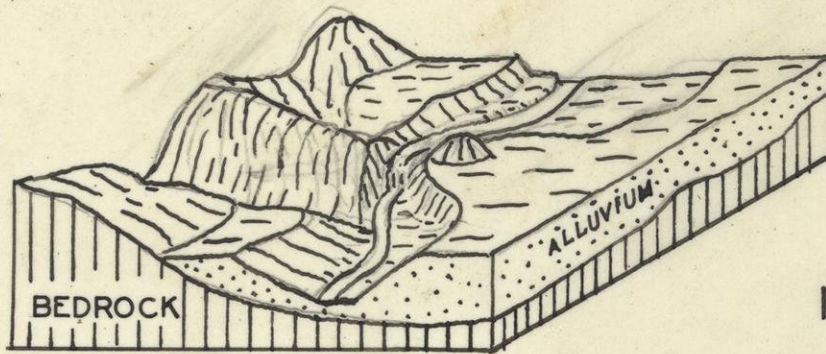

11.9

11.9

OK

11.9

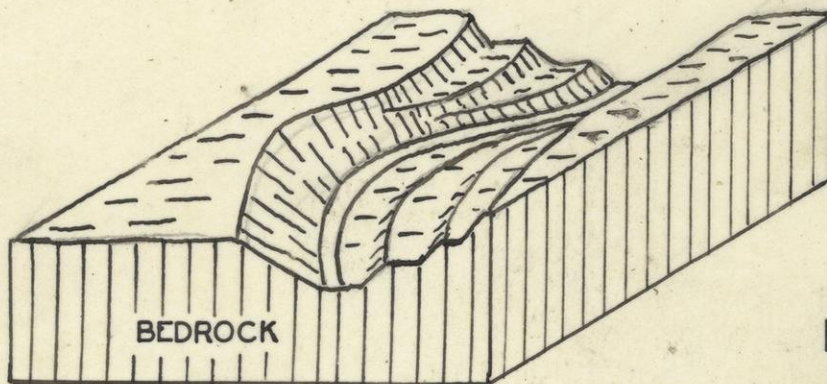

11.4

11.4

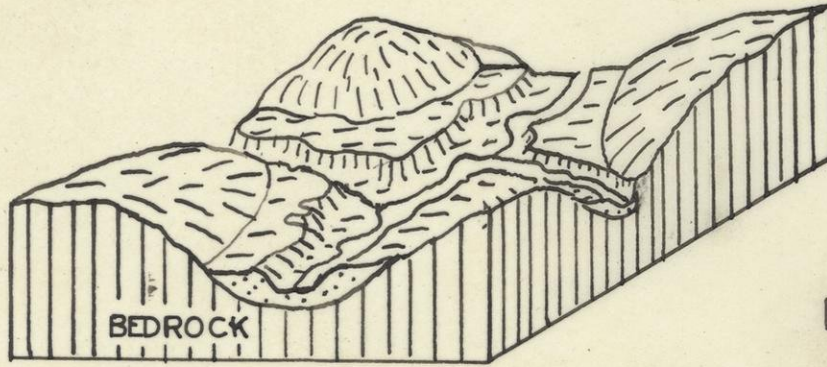

11.5

11.5

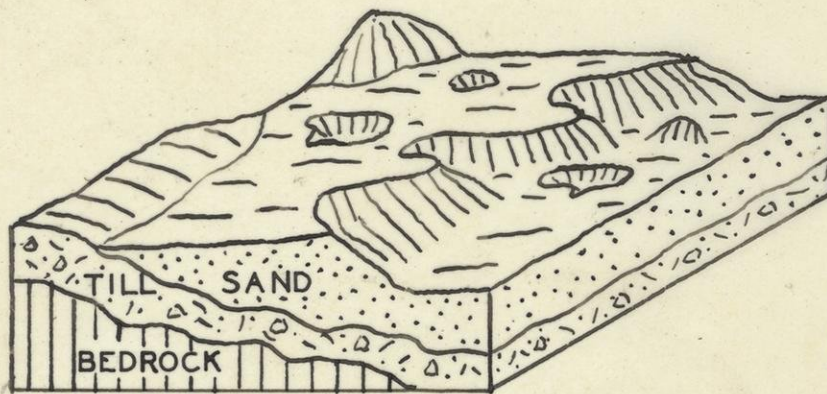

11.9

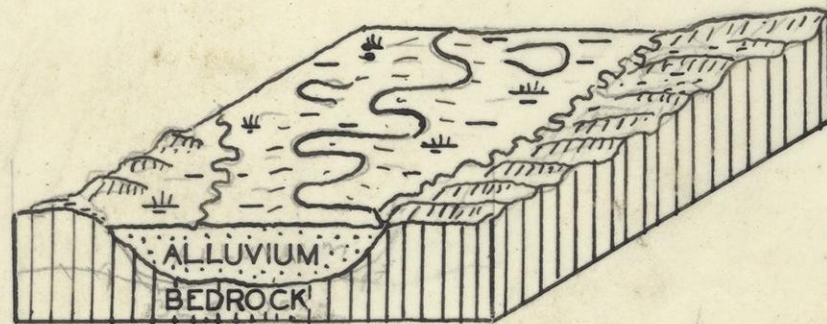

11.10

✓

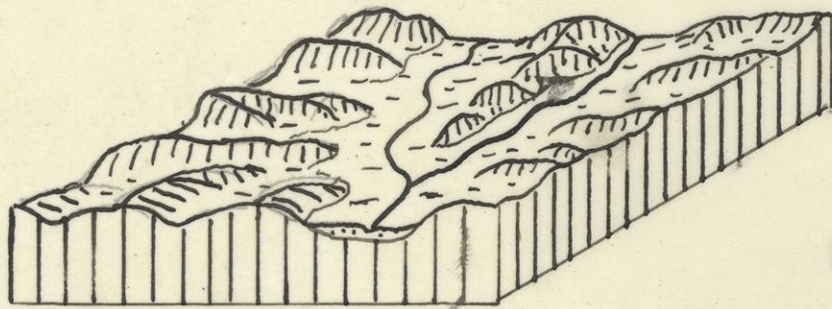

11.11 ✓

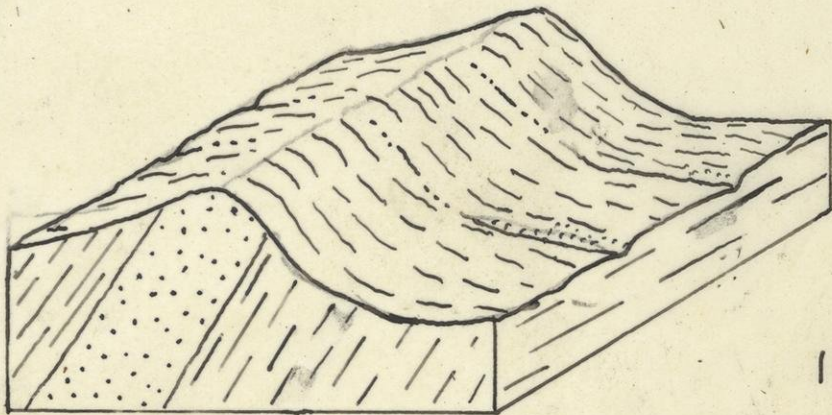

11.3

11.3

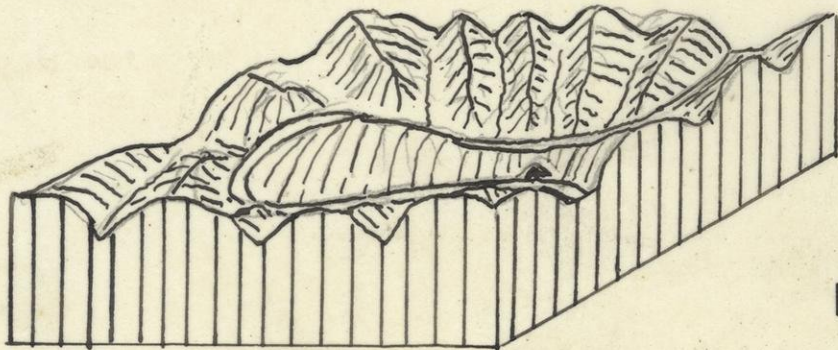

11.12

11.12

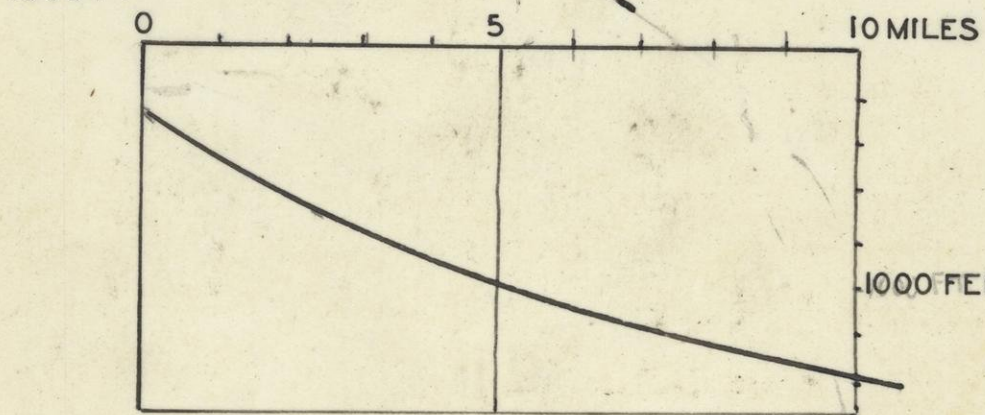
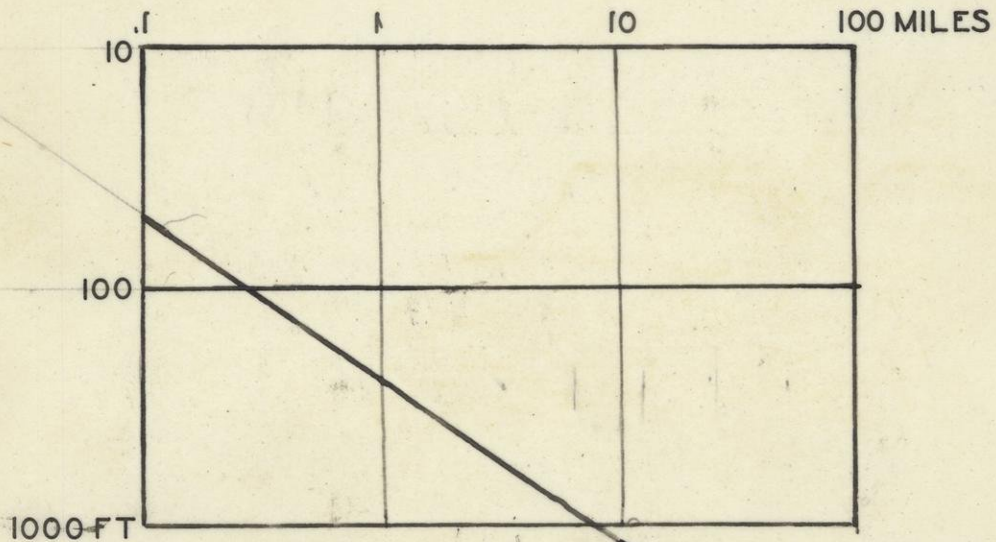

11.13

11.13

11.14

12.12

Synclinal

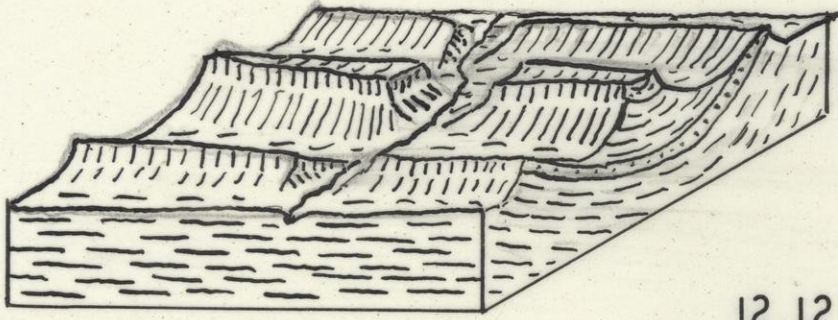

12.12

✓

plug out

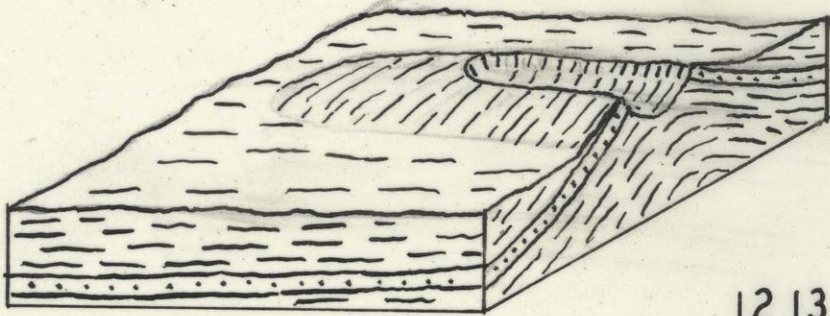

12.13

✓

plug out

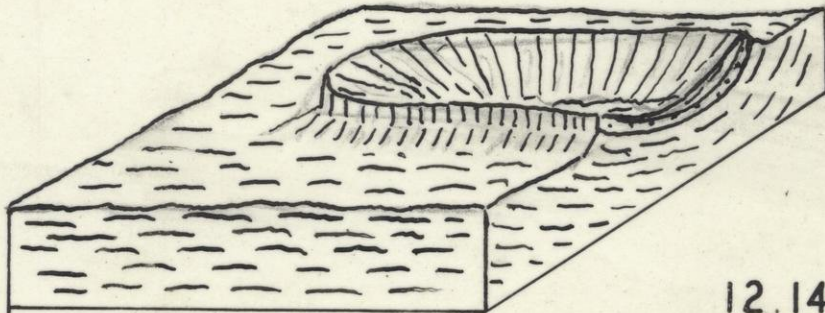

12.14

✓

12-7

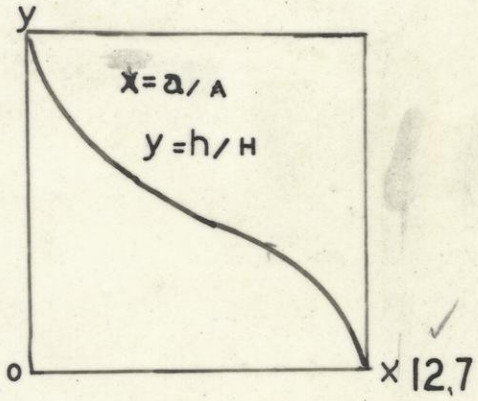

12-8

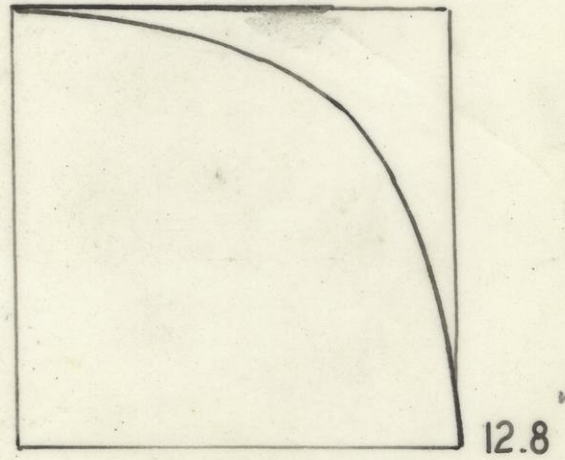

12.9

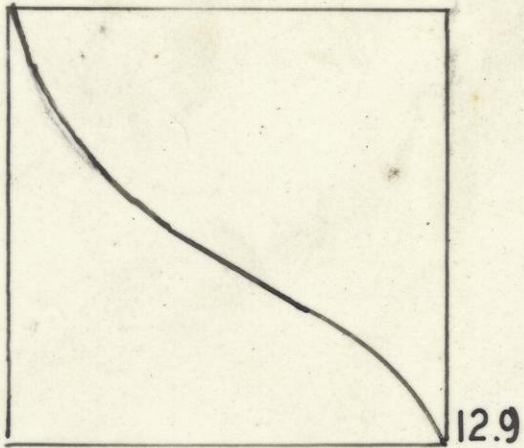

2.10

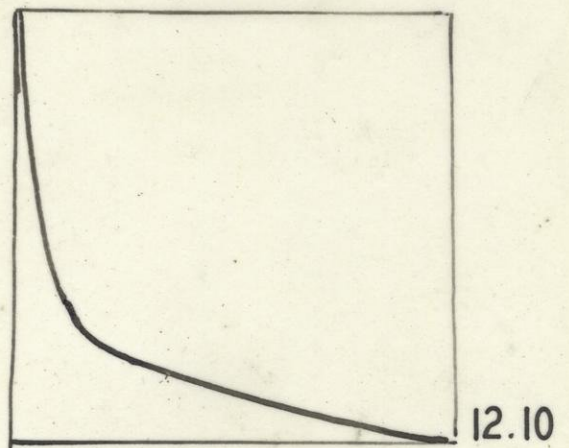

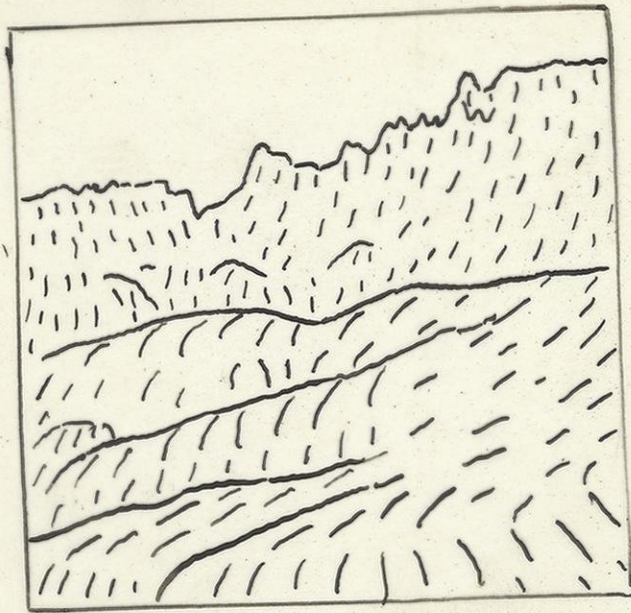

12.3

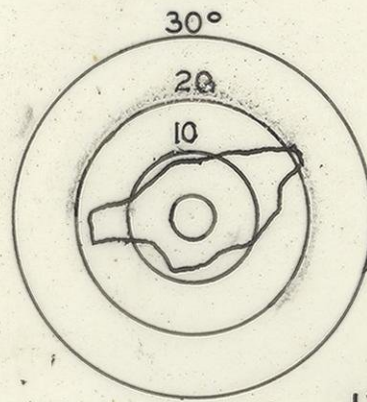

12.4 ✓

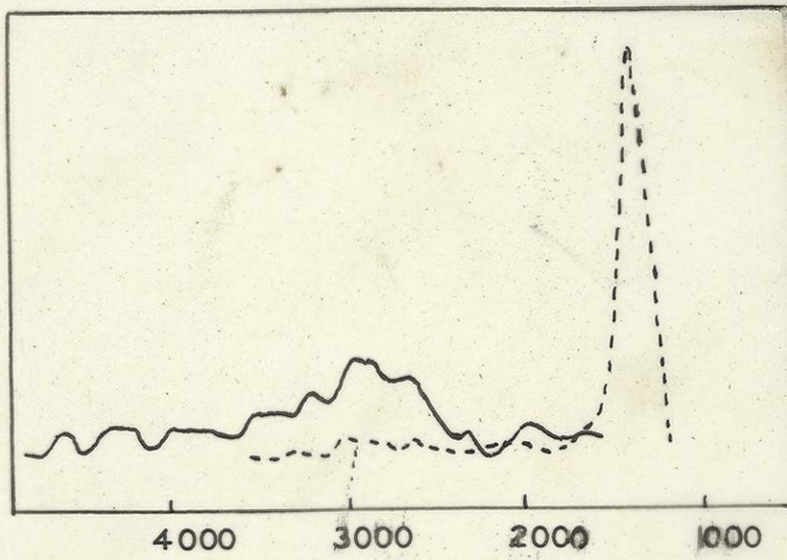

12.5 ✓

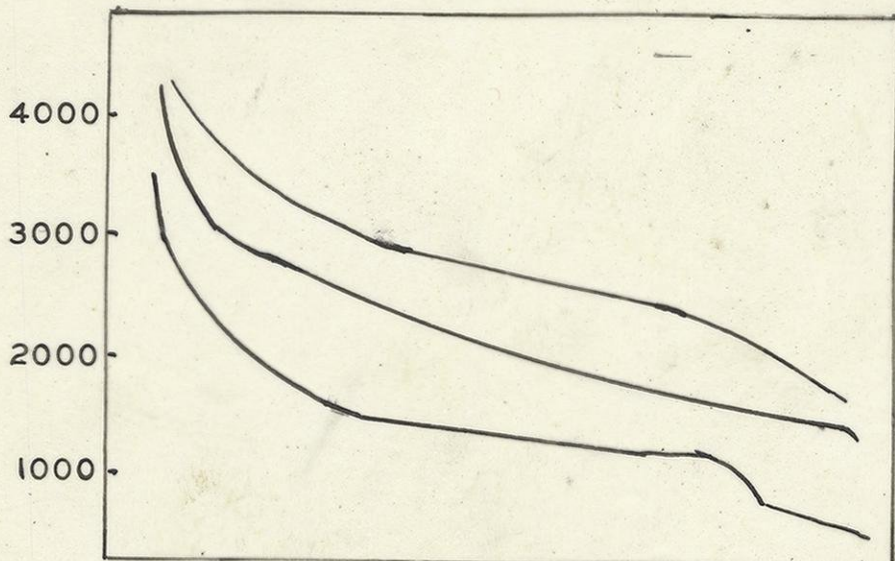

12.6 ✓

WAXING OR CONVEX SLOPE

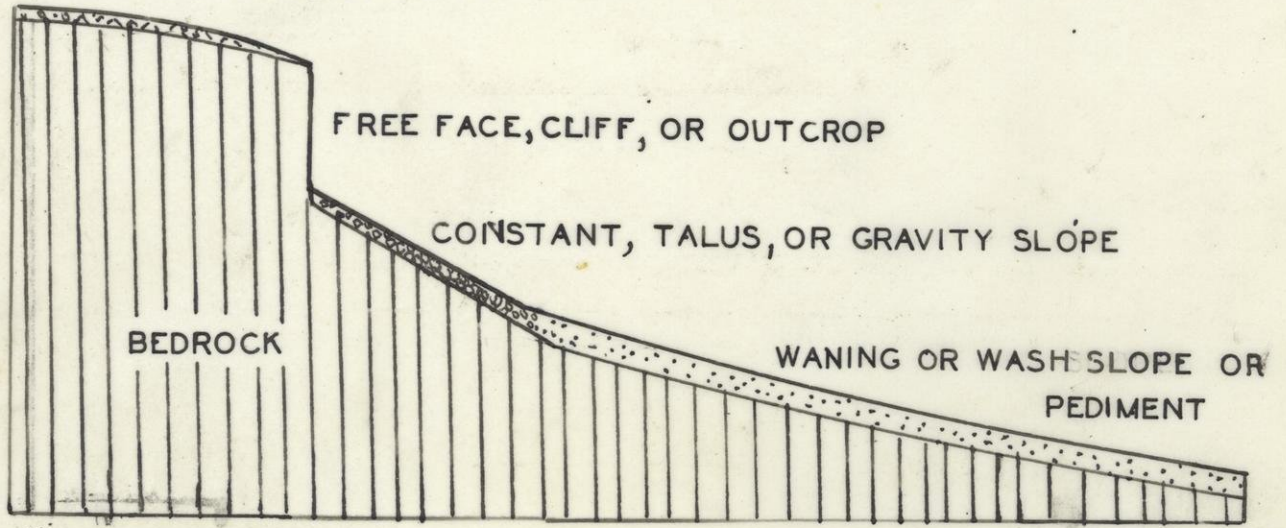

12.1



ARID



SEMIARID



HUMID

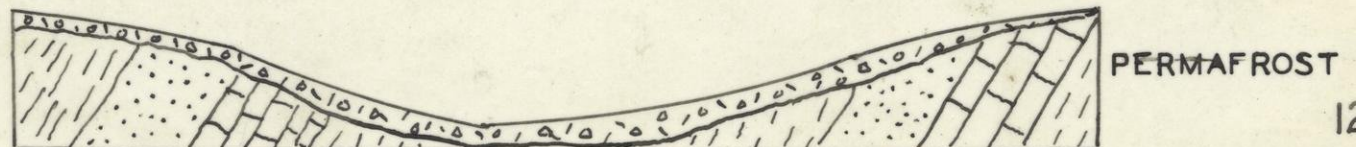

PERMAFROST

12.2

12.2

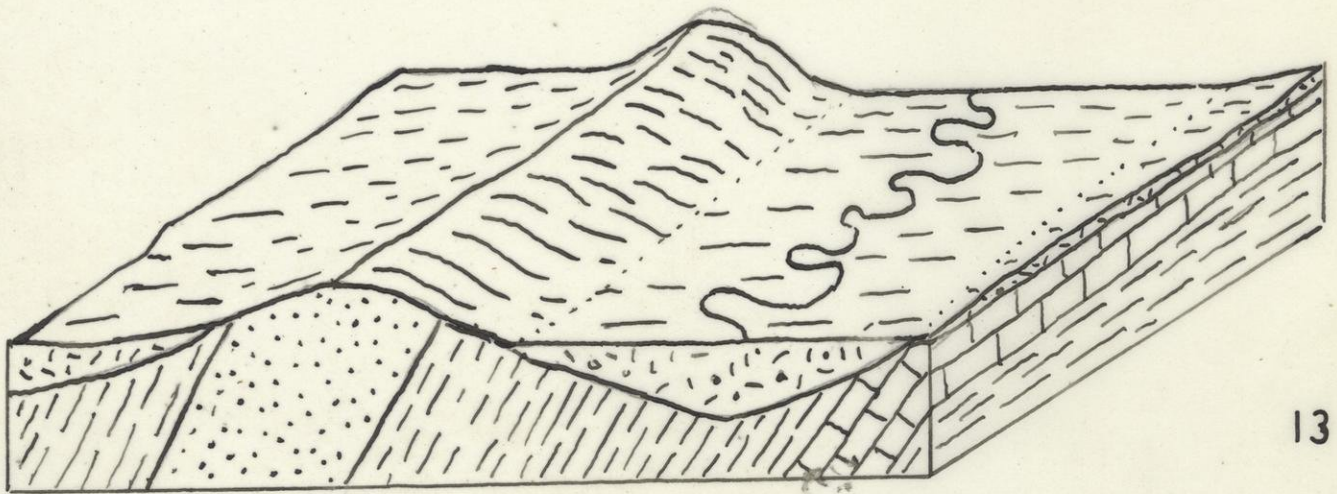

13.1 ✓

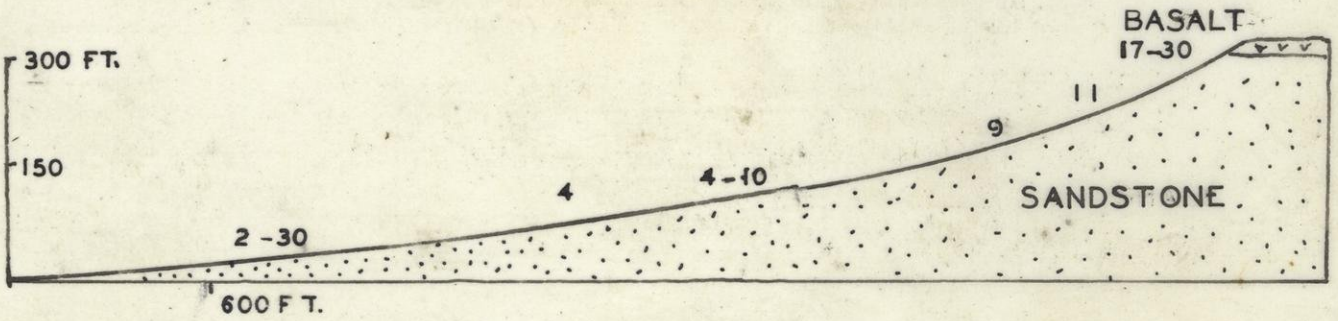
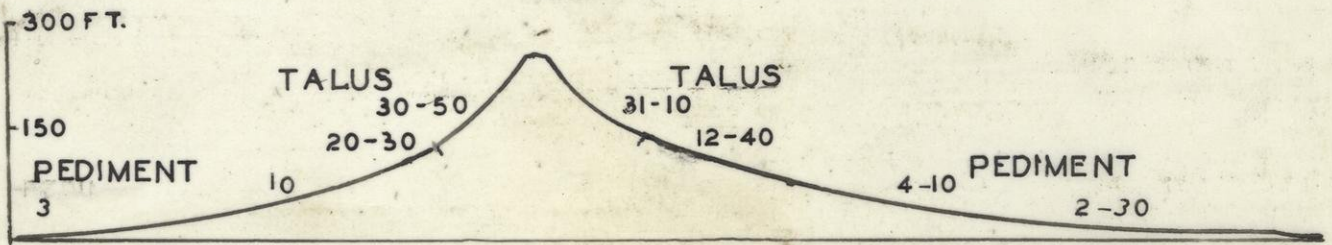

13.4

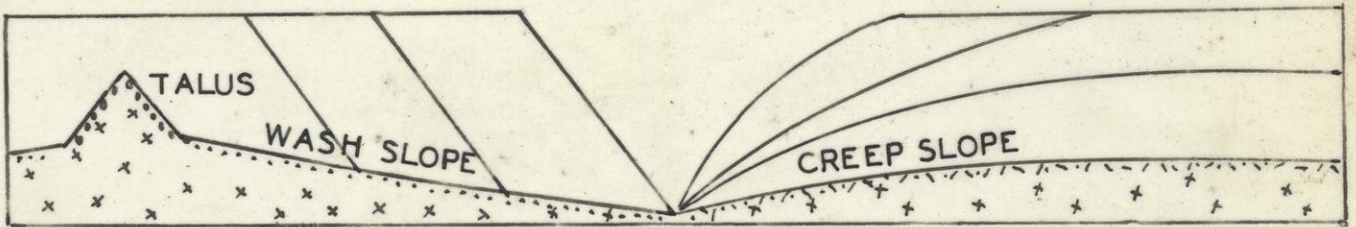

13.5

13.5

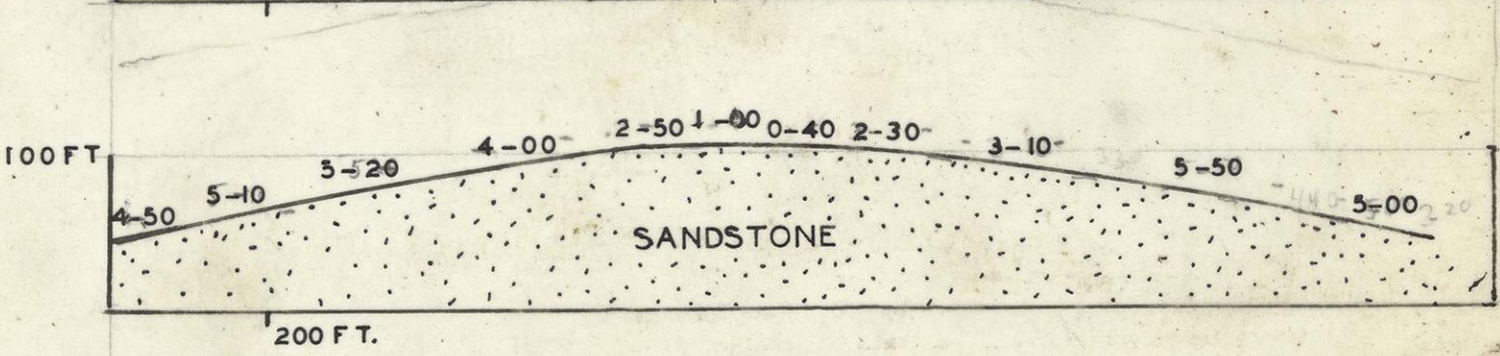
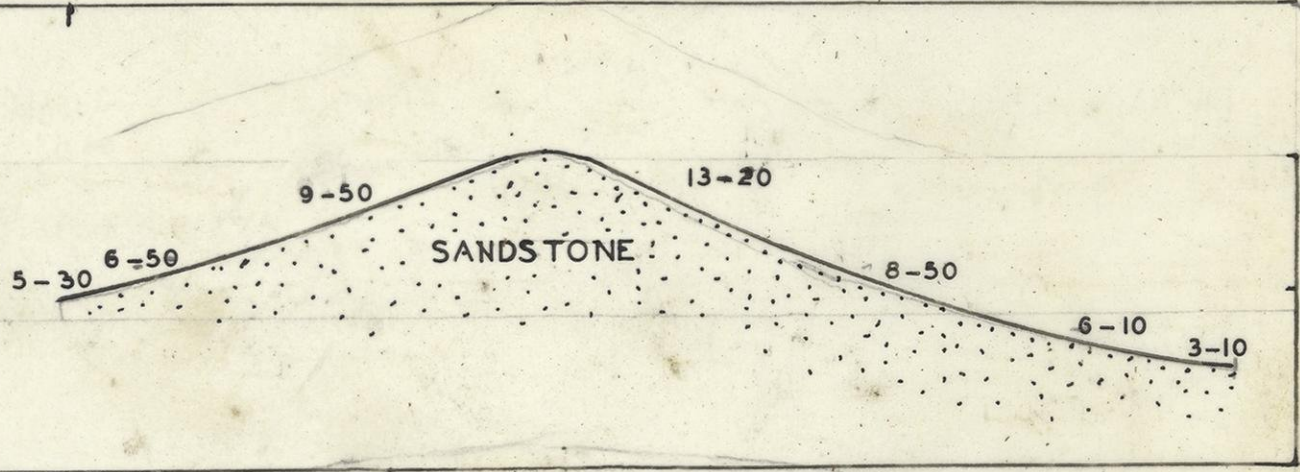
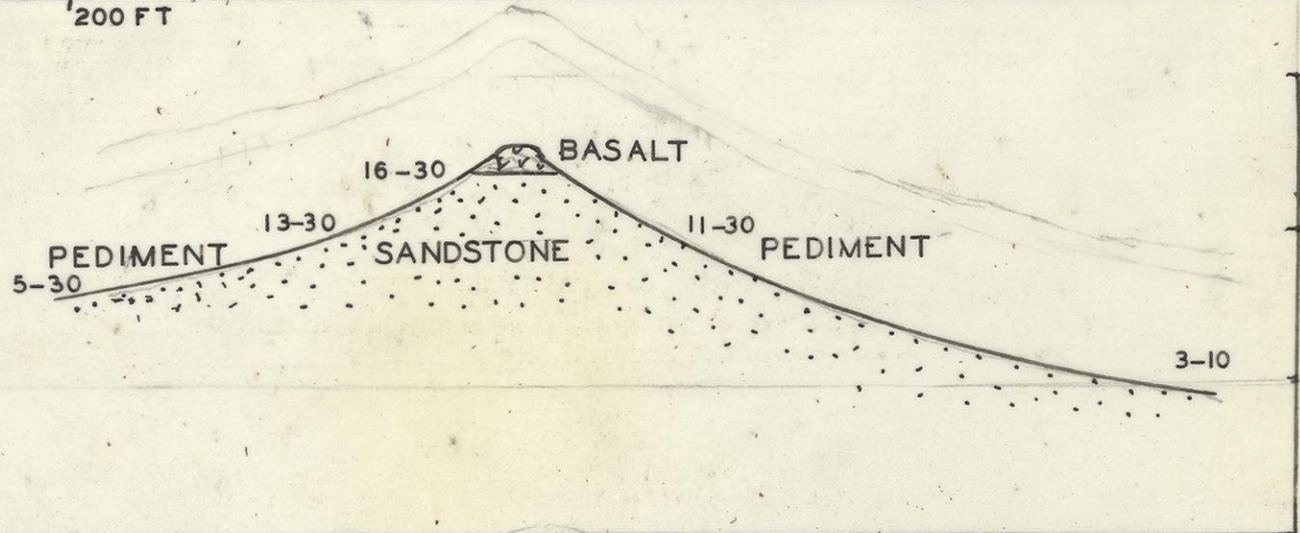
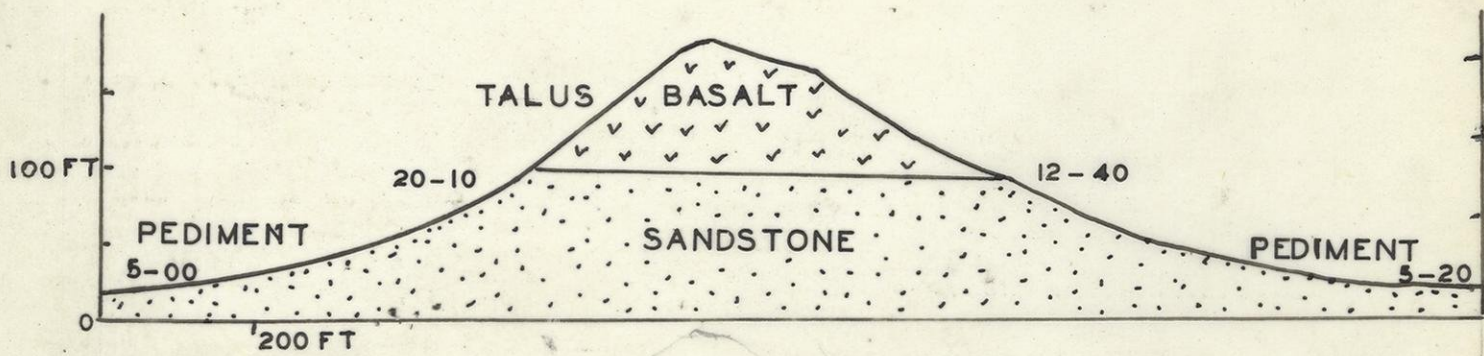

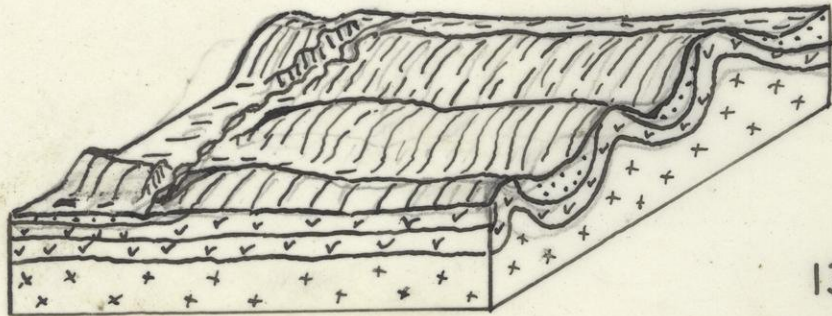

13.7

13.7

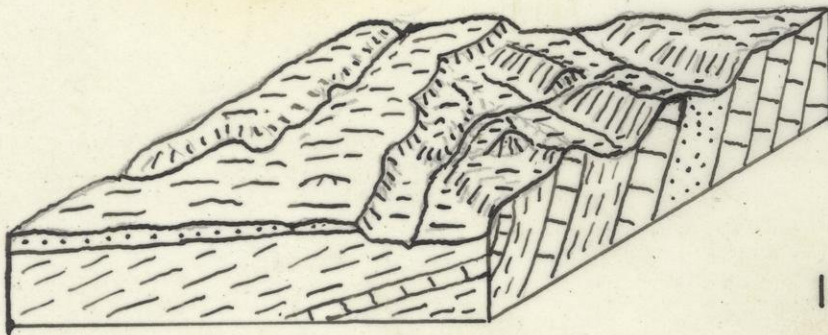

13.2

13.2

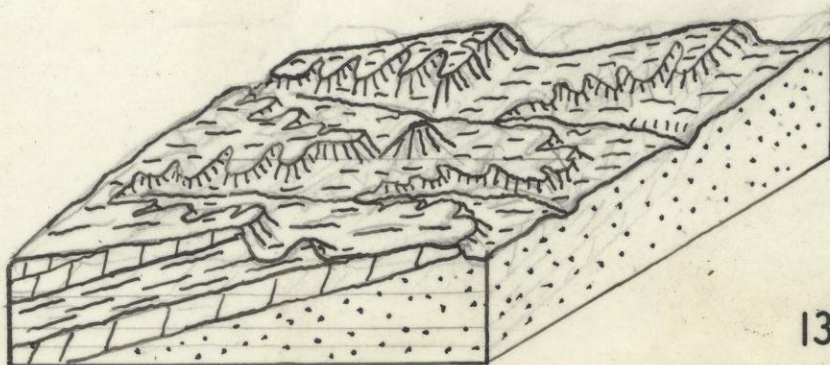

13.3

13.3

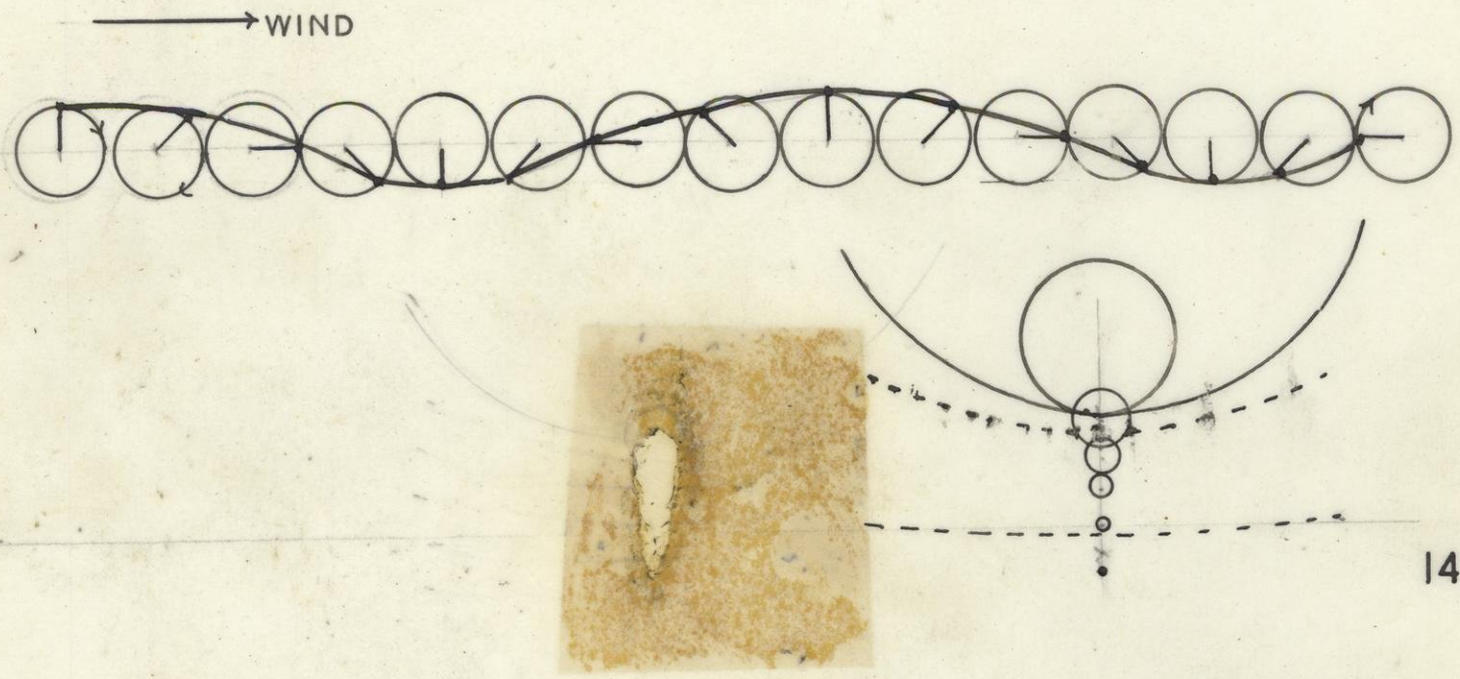

14.1 ✓

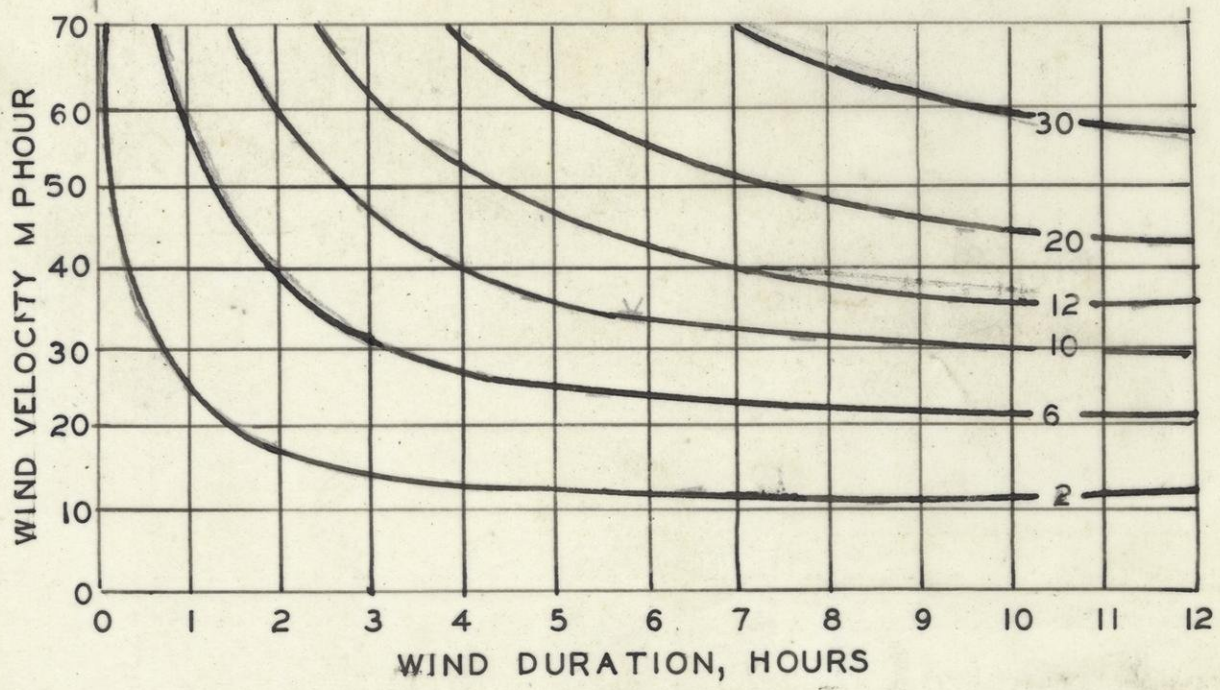

14.2

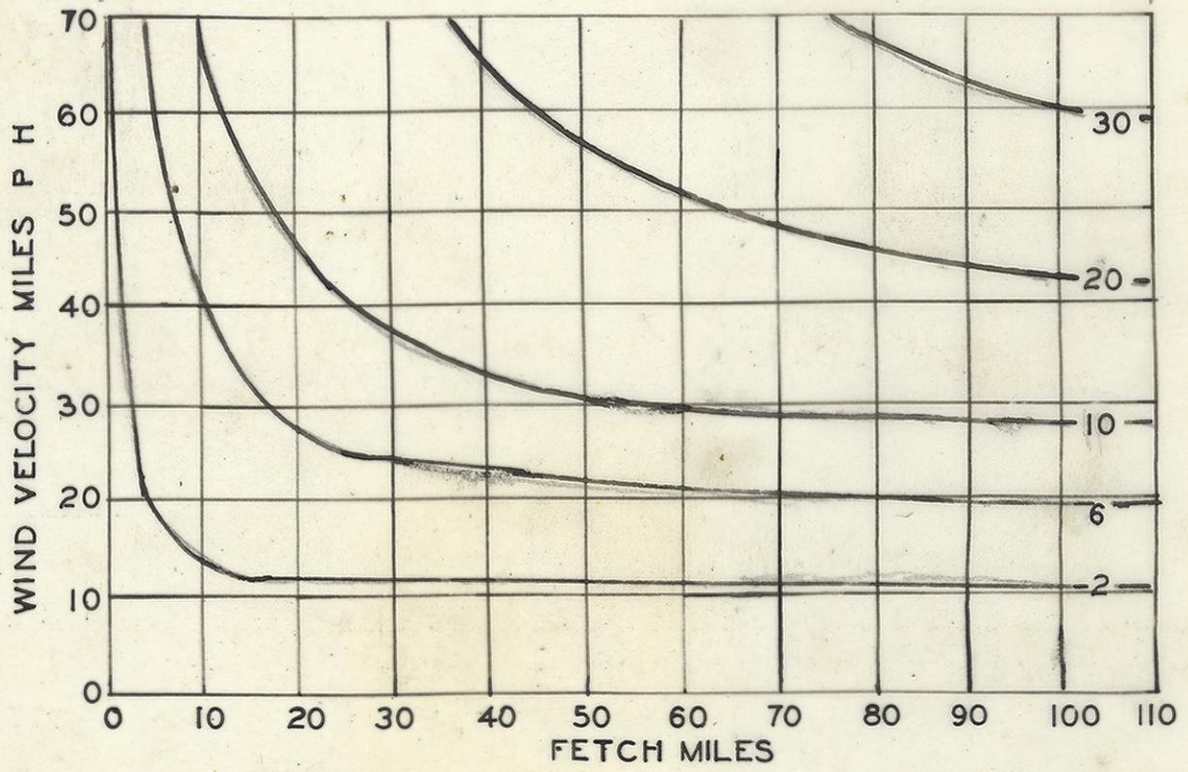

14.3 ✓

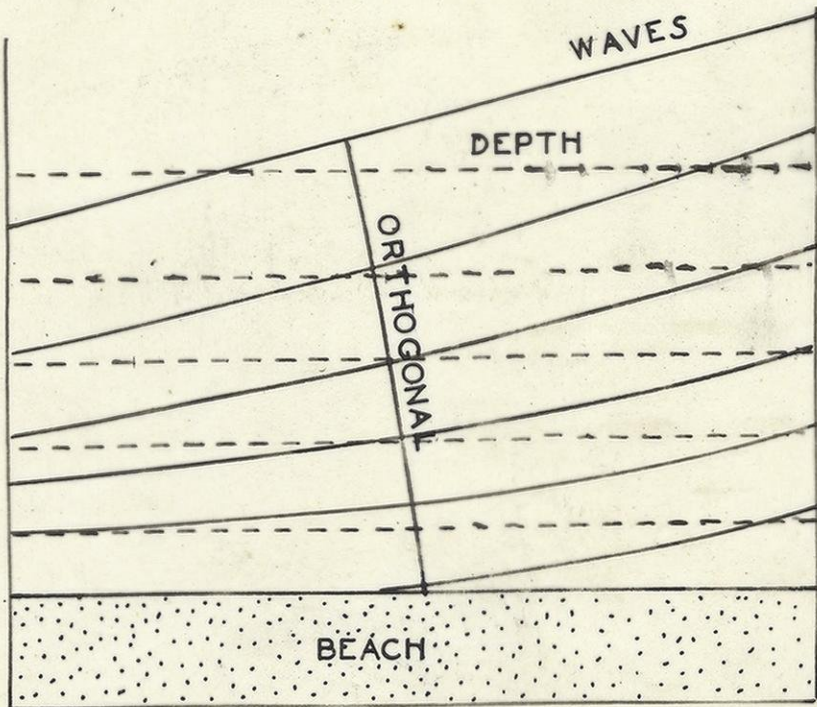

14.4 ✓

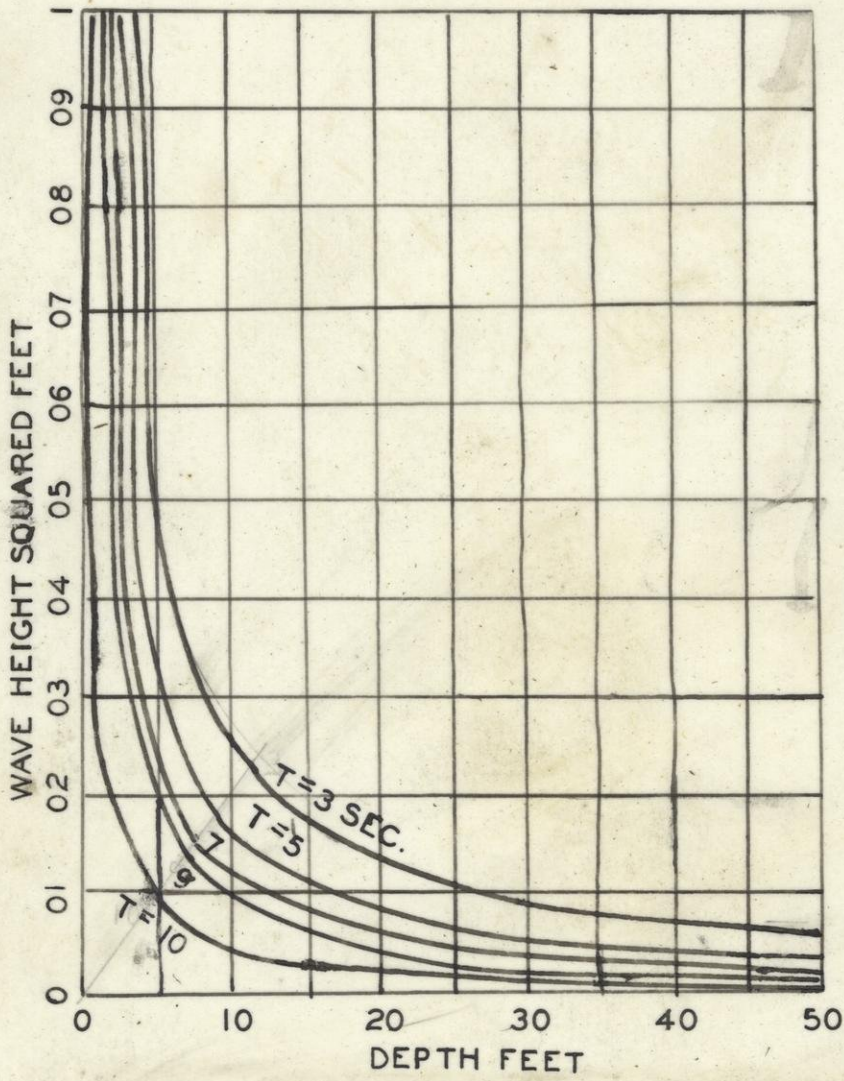

14.5 ✓

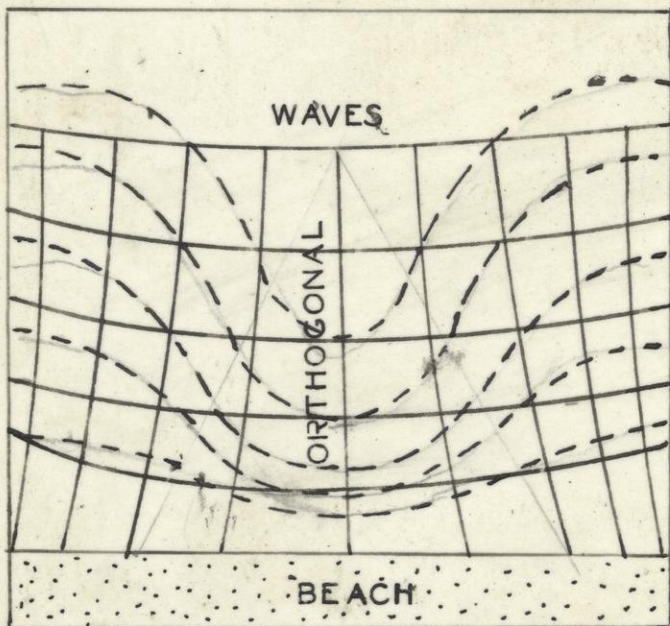

14.6 ✓

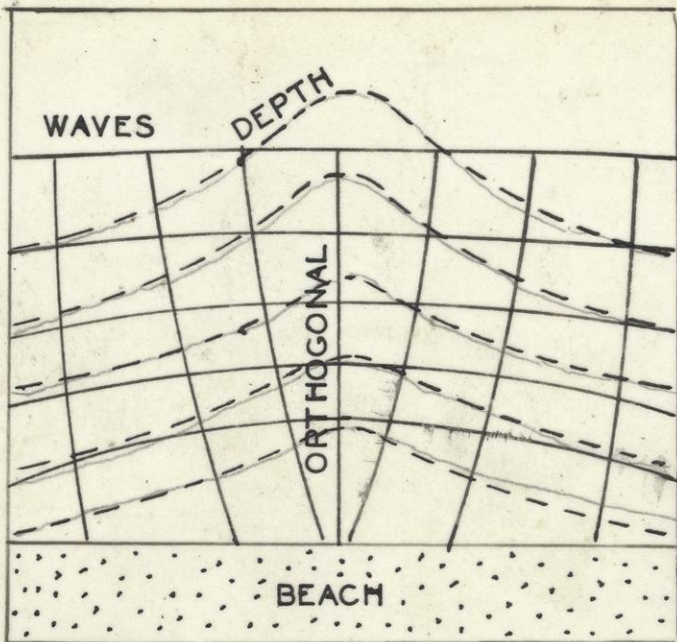

14.7 ✓

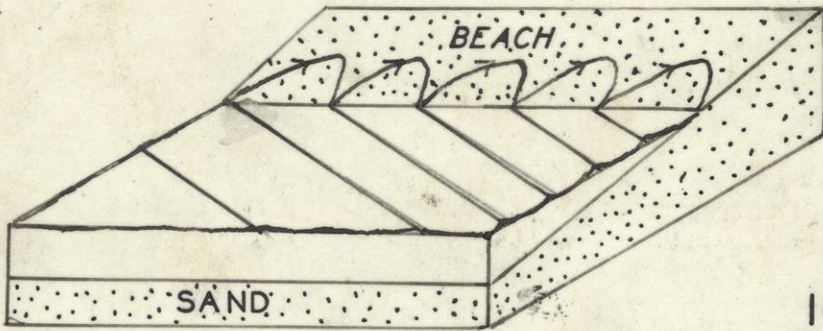

14.8 ✓

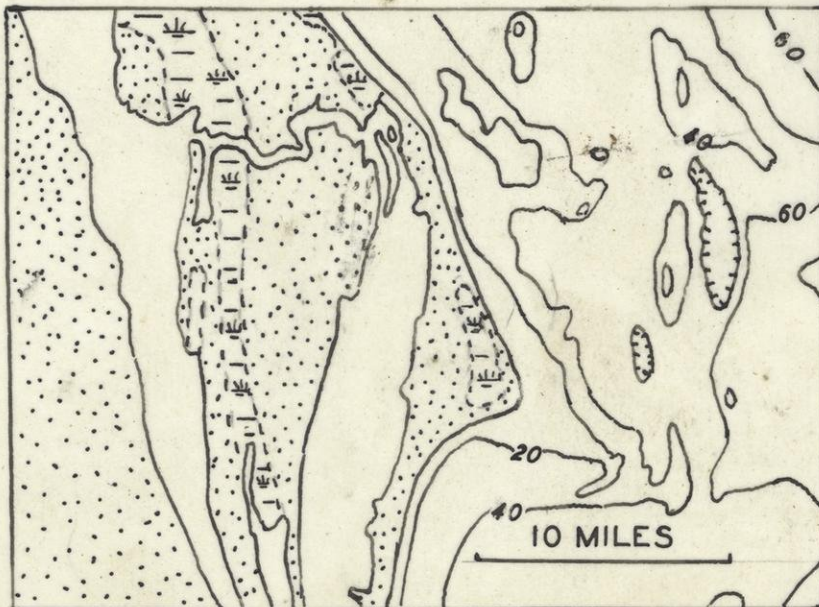

14.16

1416

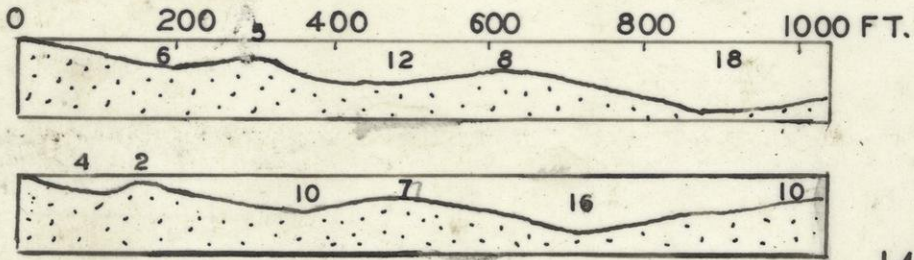

1414
14.14

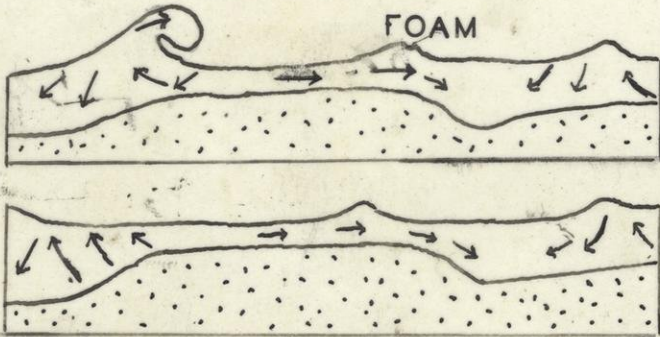

1415
14.15

6 MILES

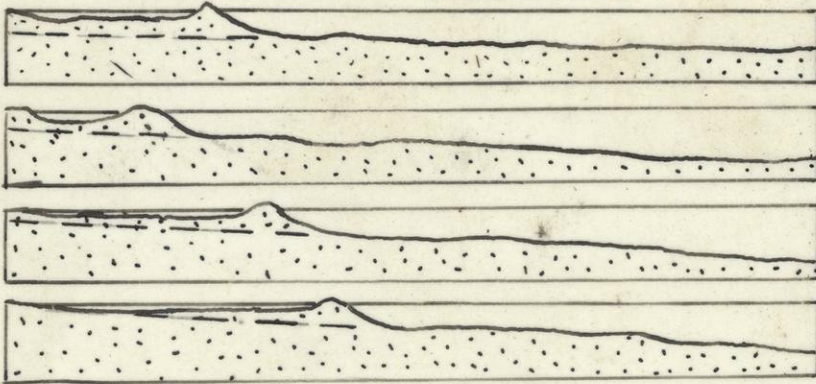

1413
14.13

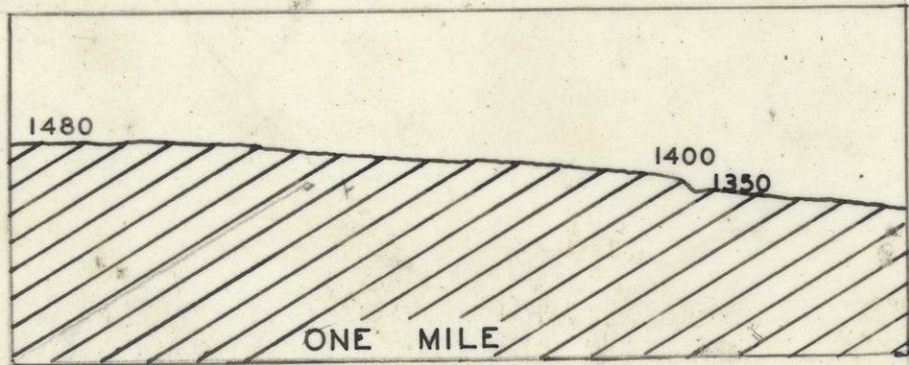

1417
14.17

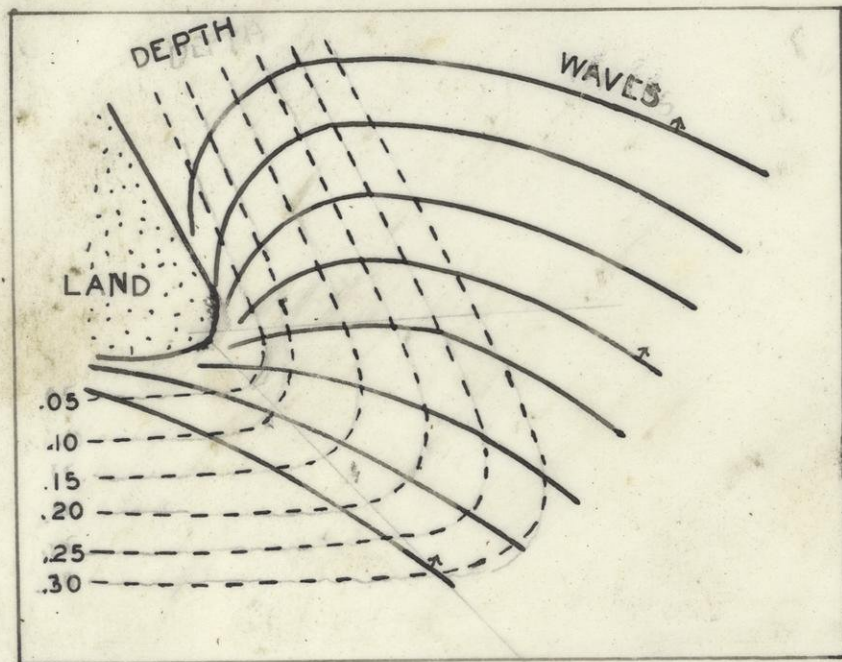
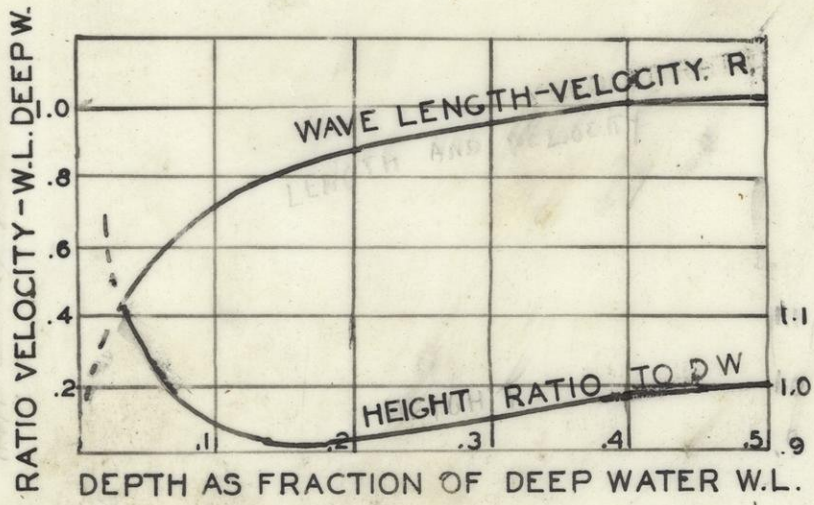

DEPTH AS FRACTION OF DEEP WATER WAVE L. 14.10

14-16

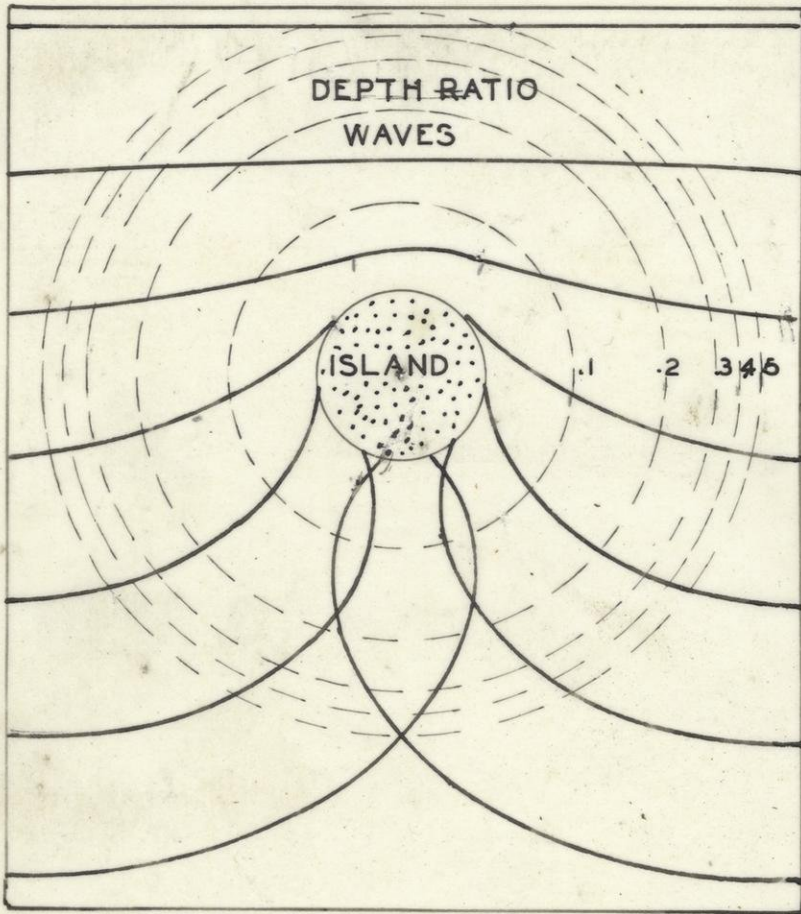

14.11

14.11

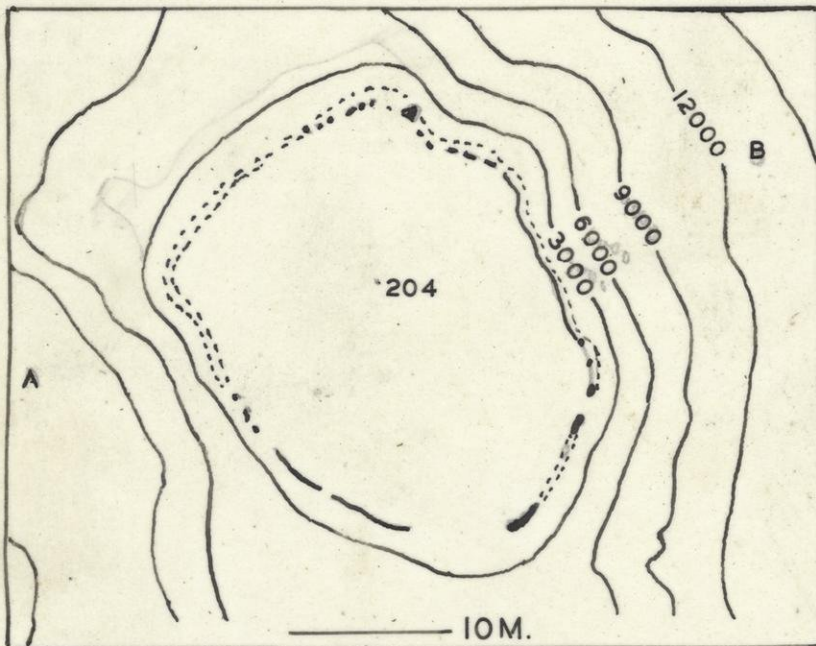

500
1000

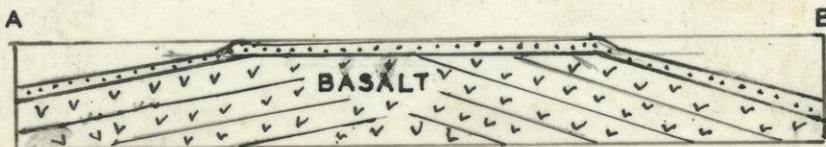

14.20

1420

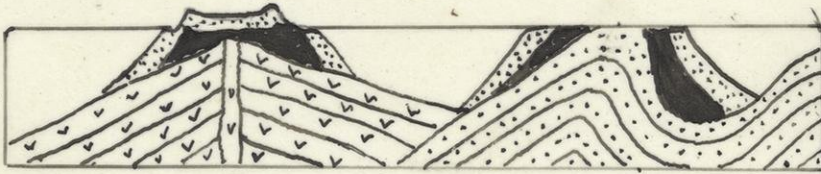
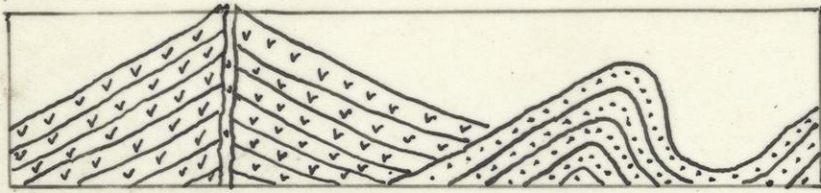

1419

14.19

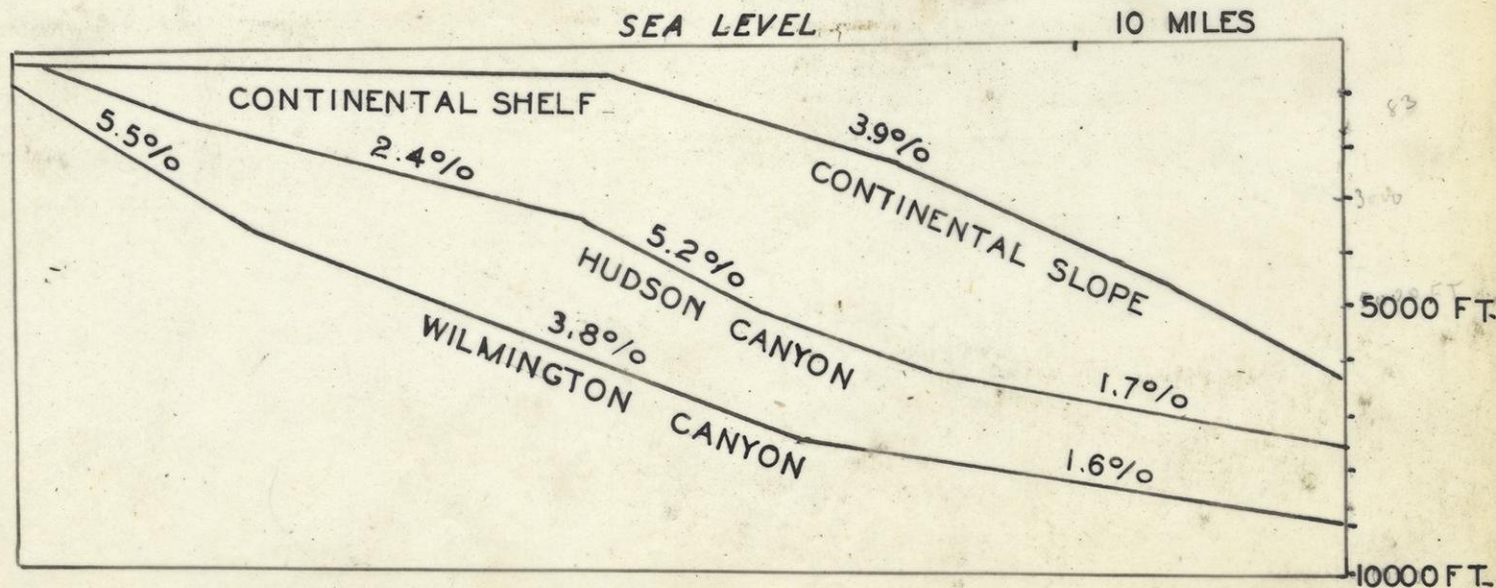

1422

14.22

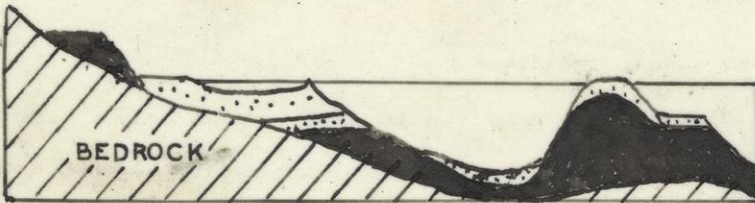
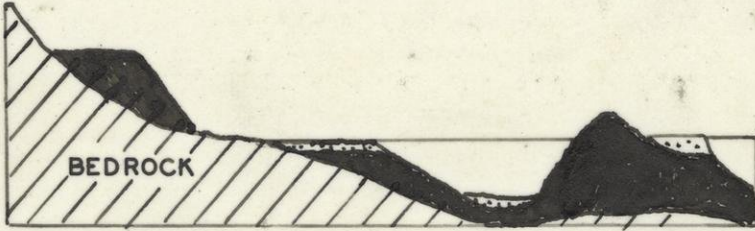
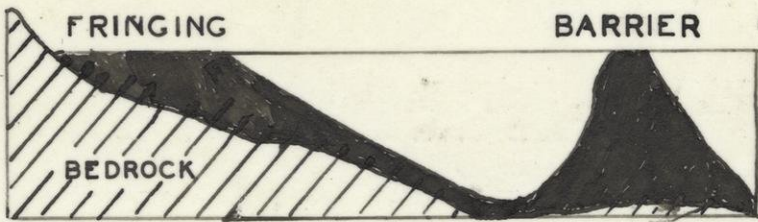

14. 18

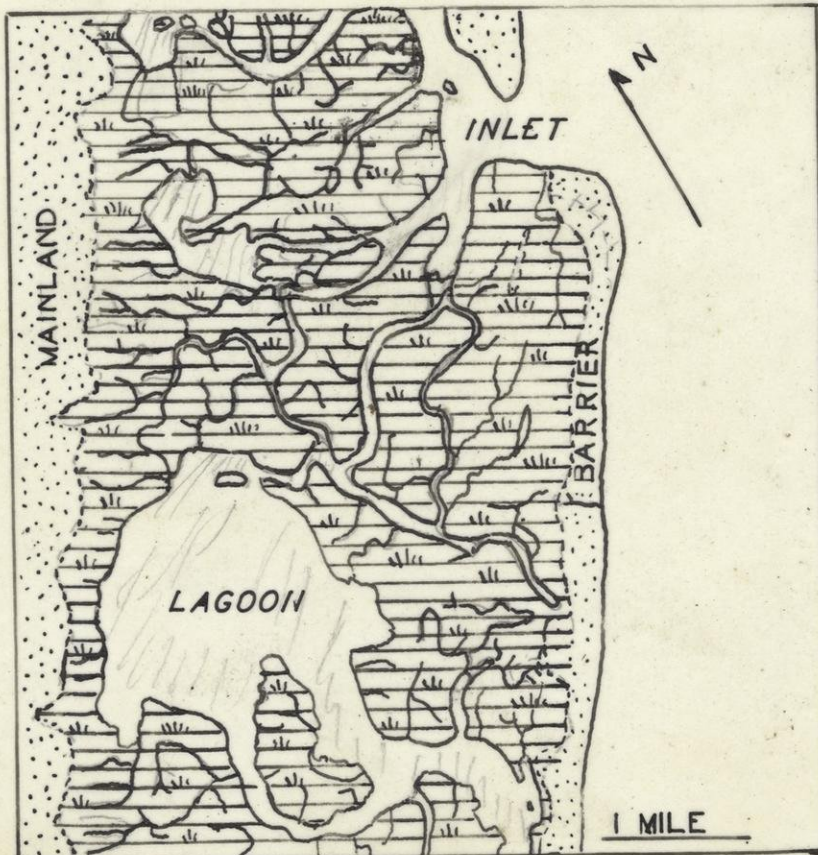

14. 21

1421

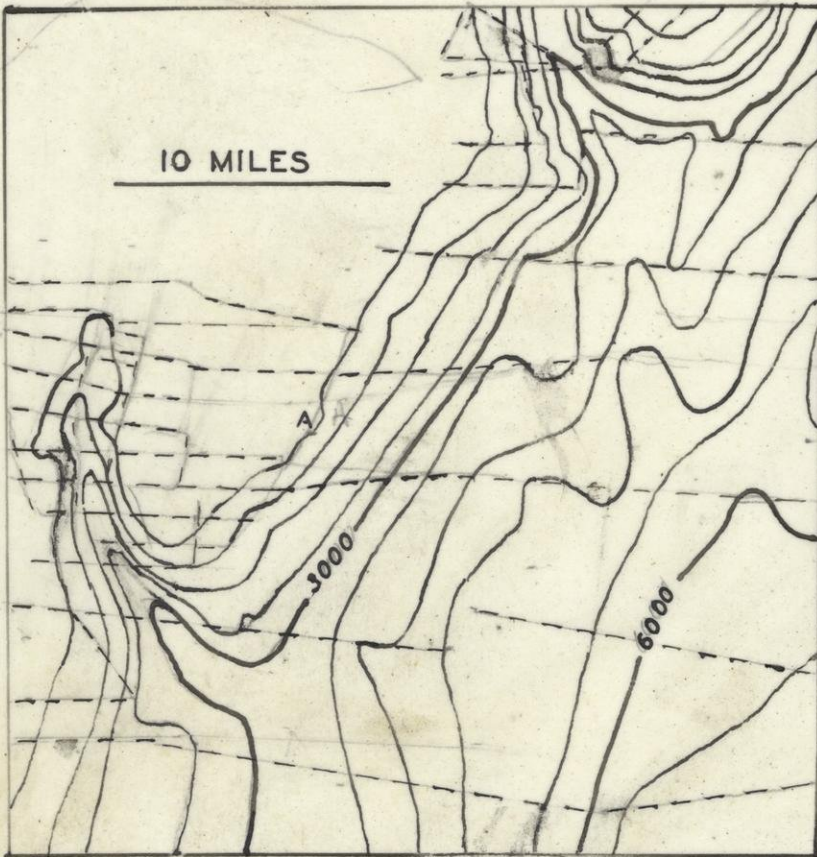

14.23

1423

1423

X

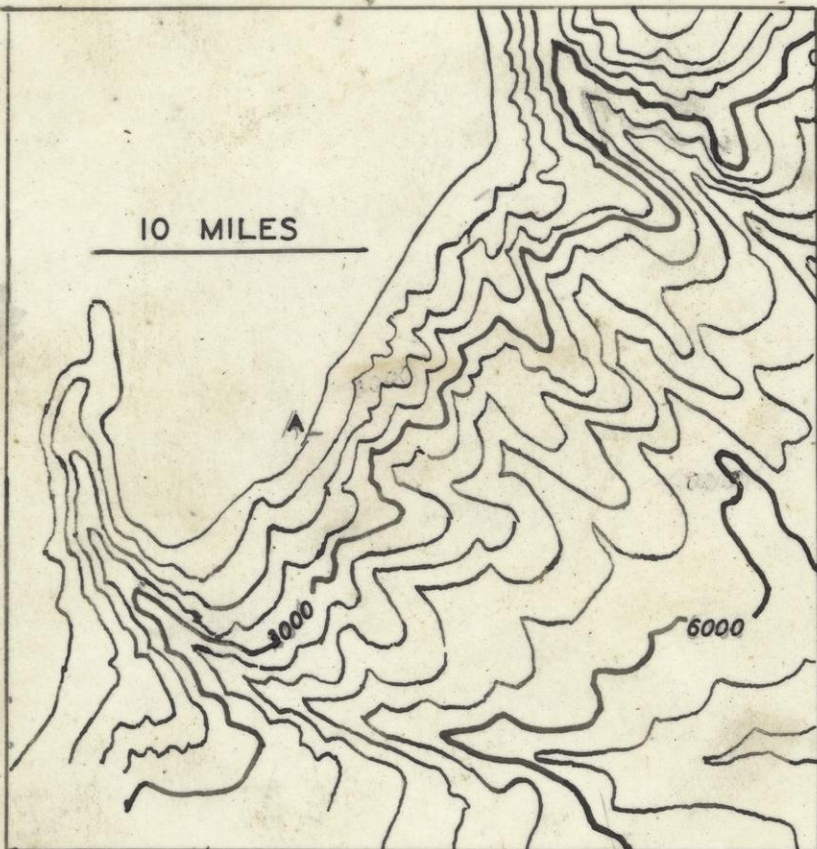

14.24

77

1424

4.25

1425

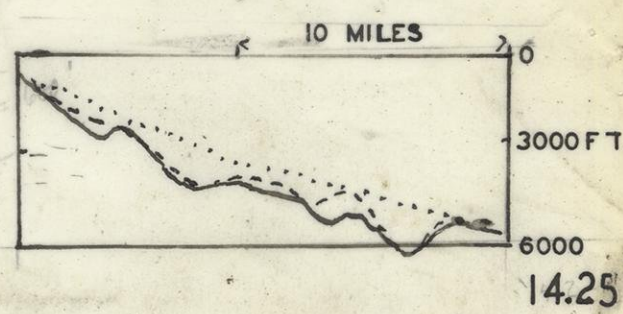
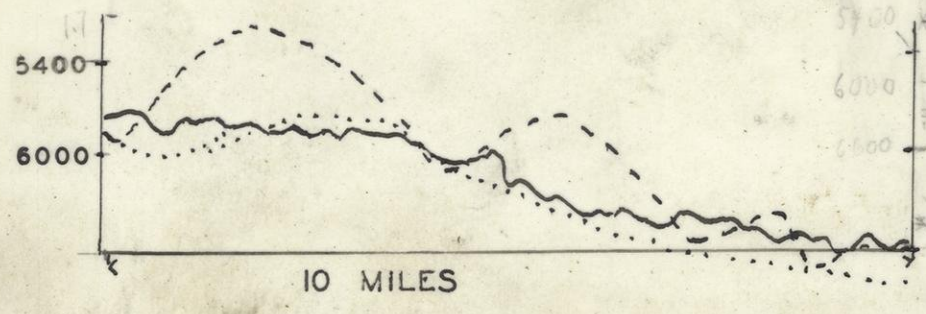

14.25

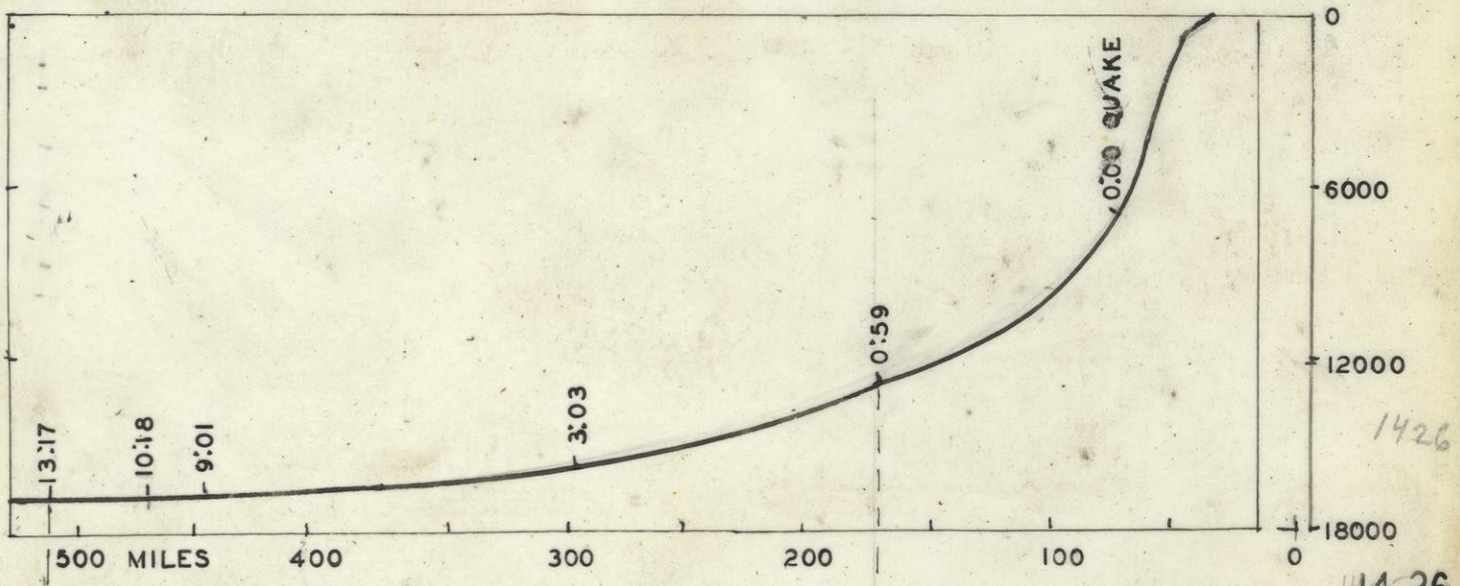

1426

14.26

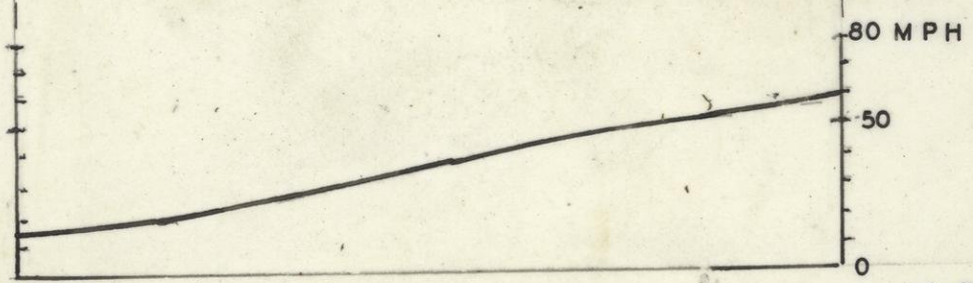

1427

14.27

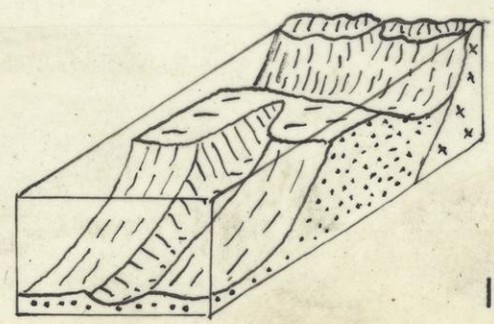
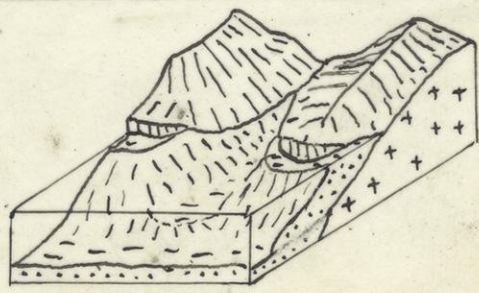

14.29 1429

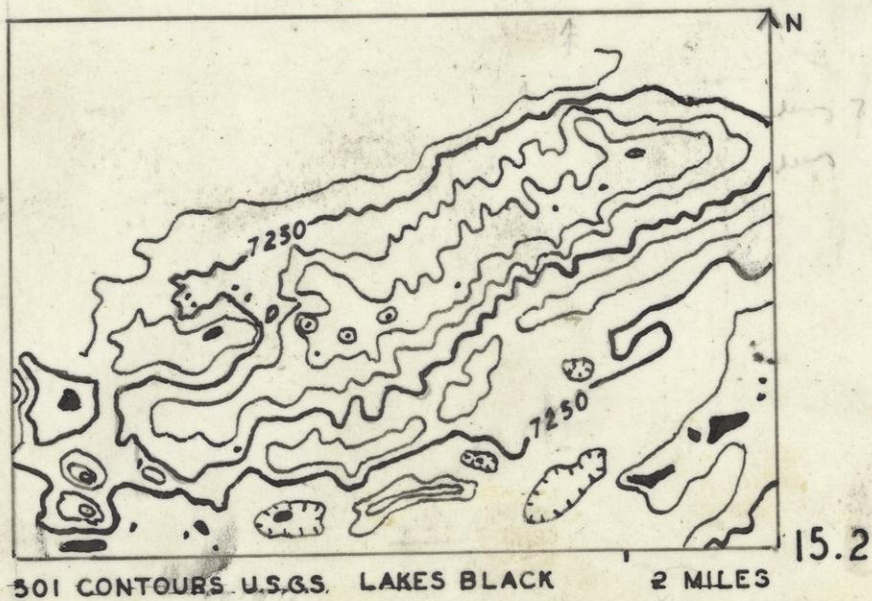
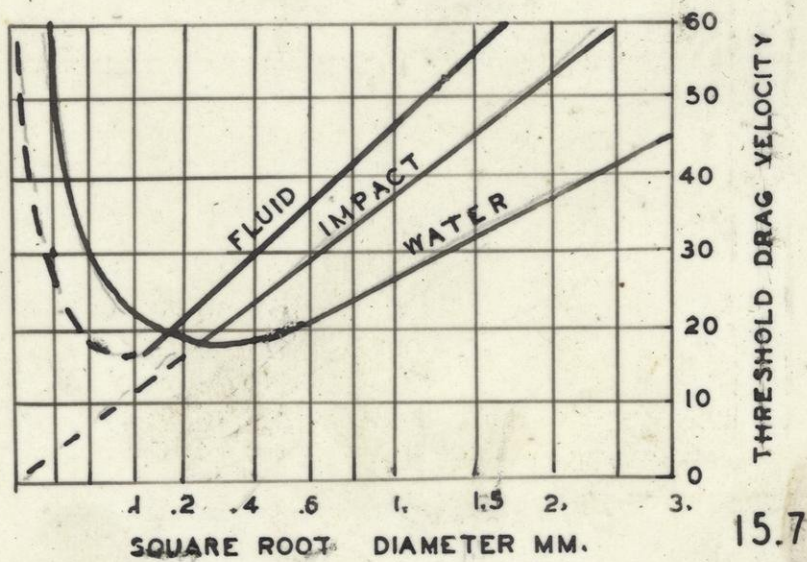
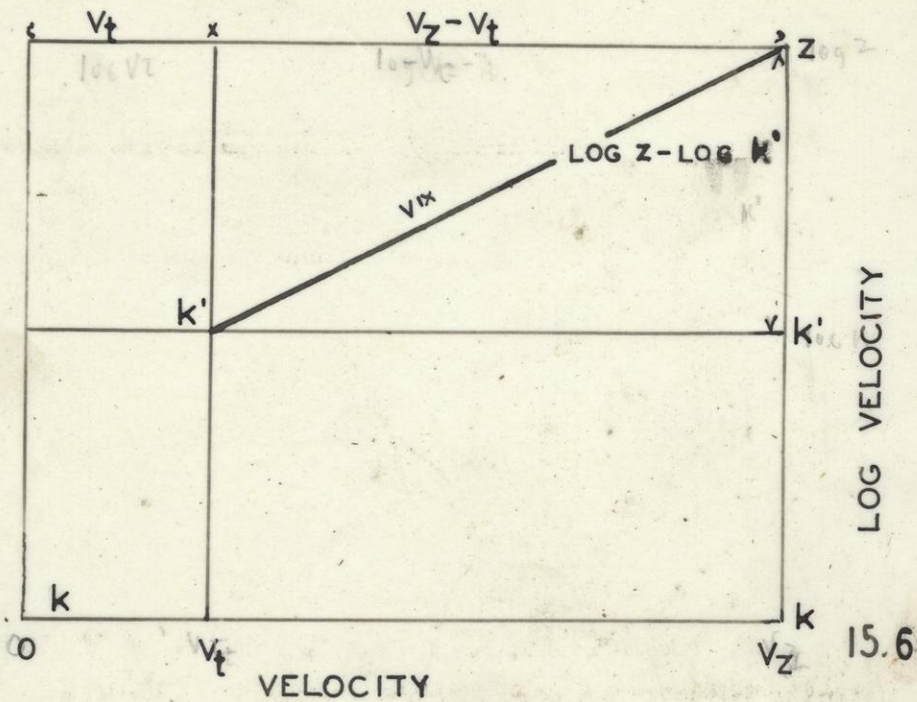

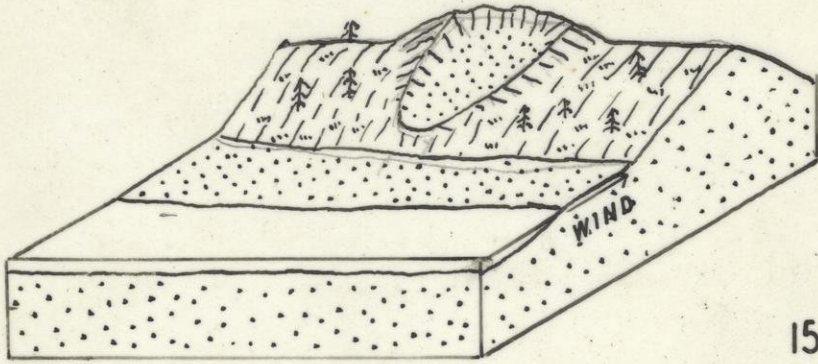

15.11

15.11

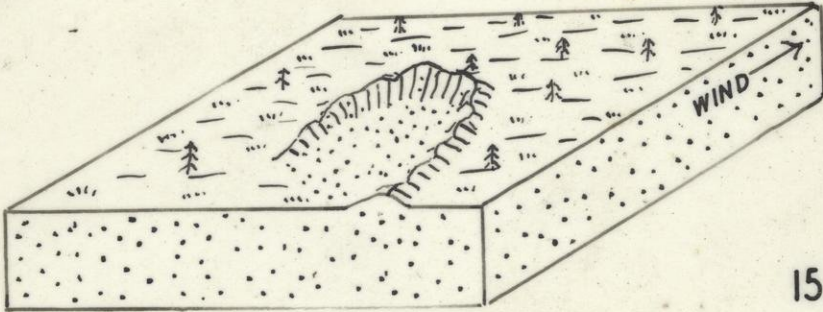

15.12

15.12

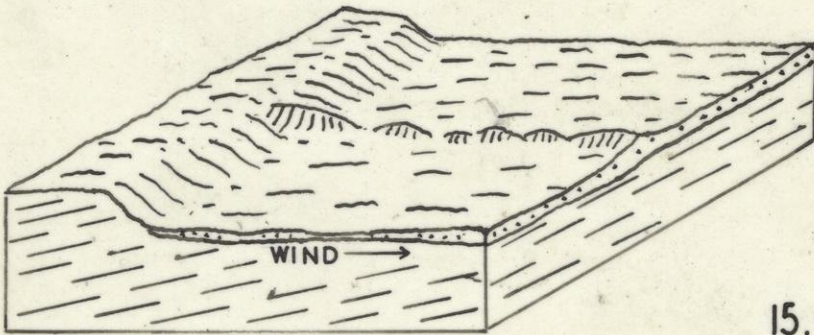

15.10

✓

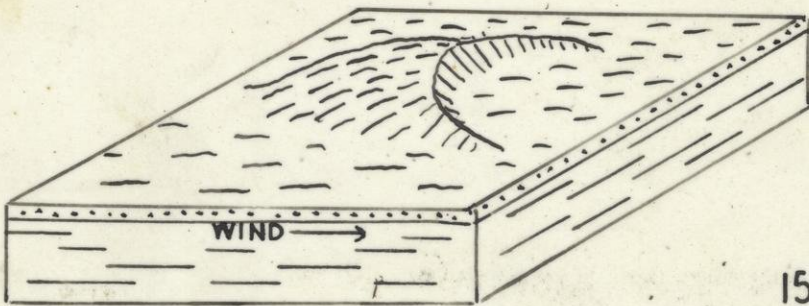

15.8

15.8

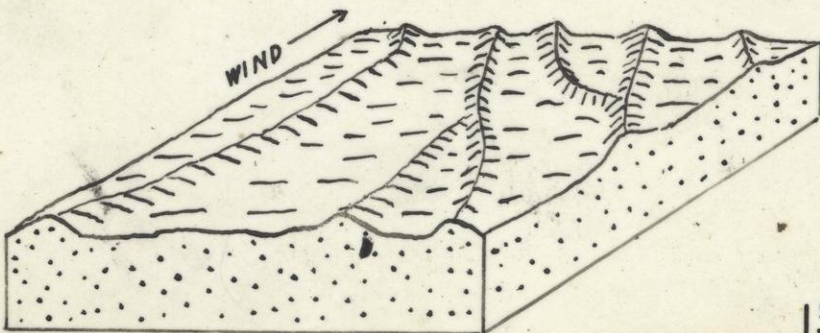

15.9

15.9

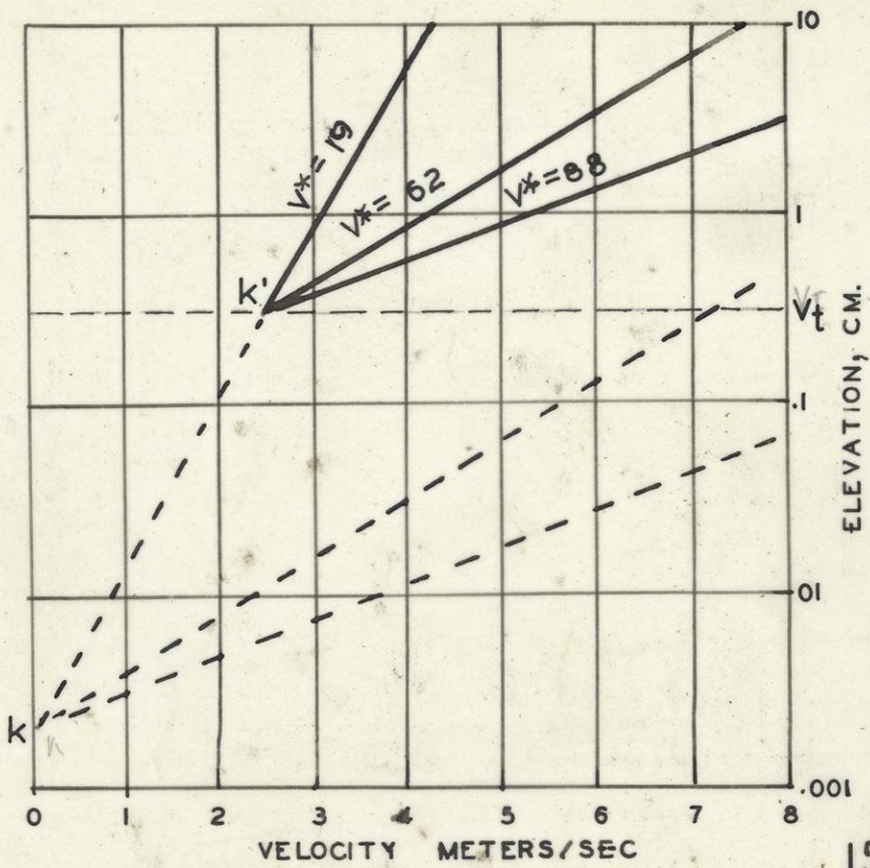

15.4

15.4

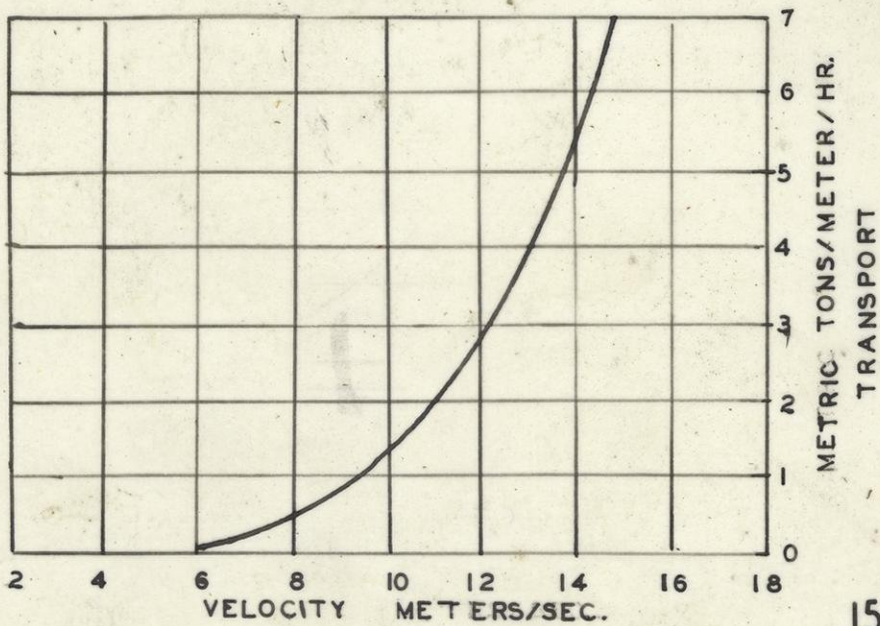

15.5

15.5



VELOCITY OF FALL

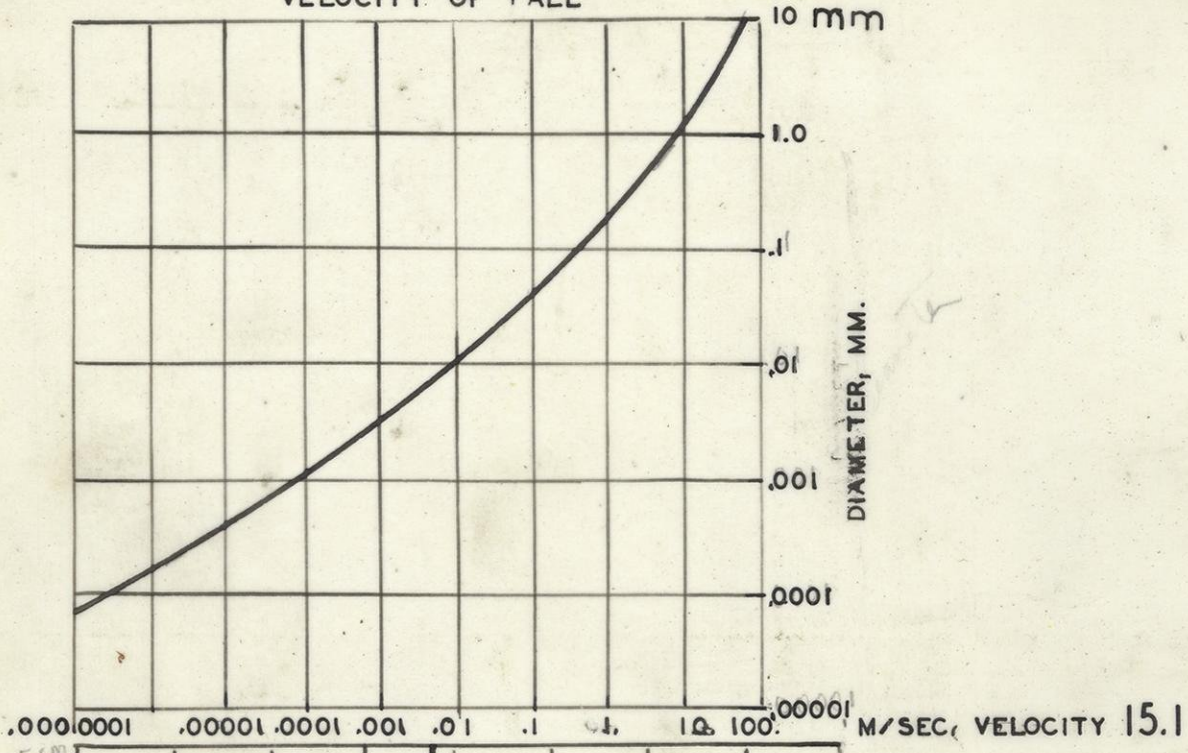

ELEVATION

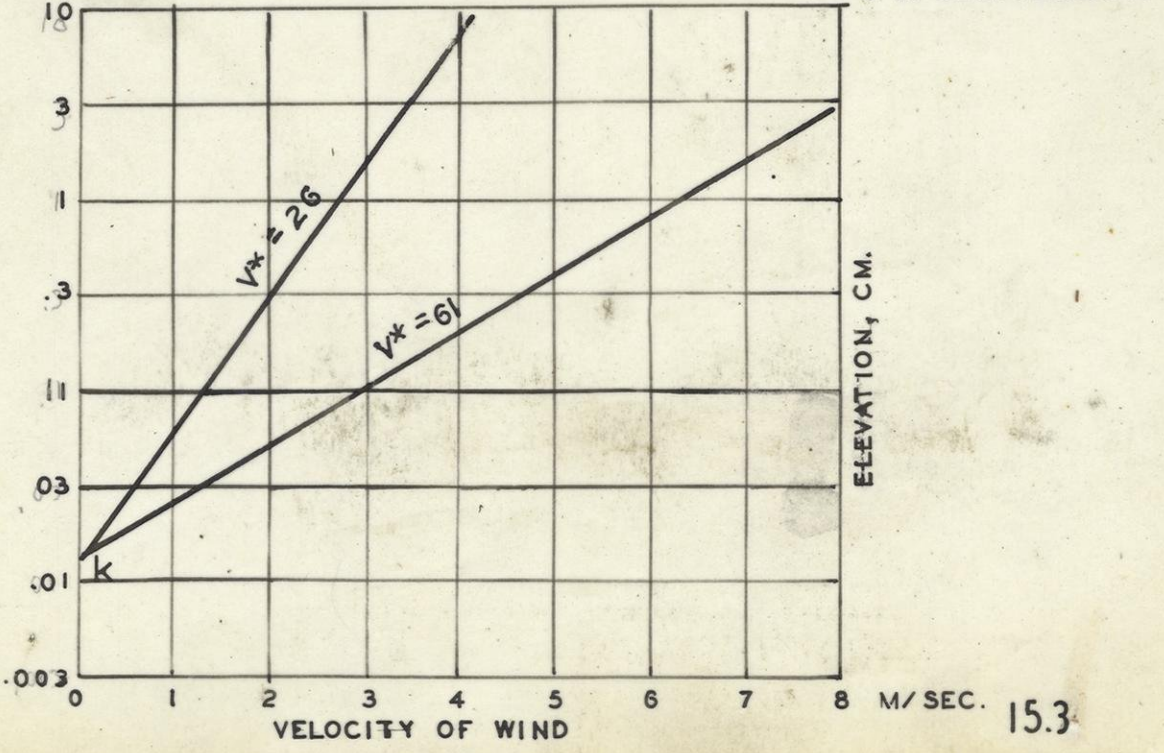
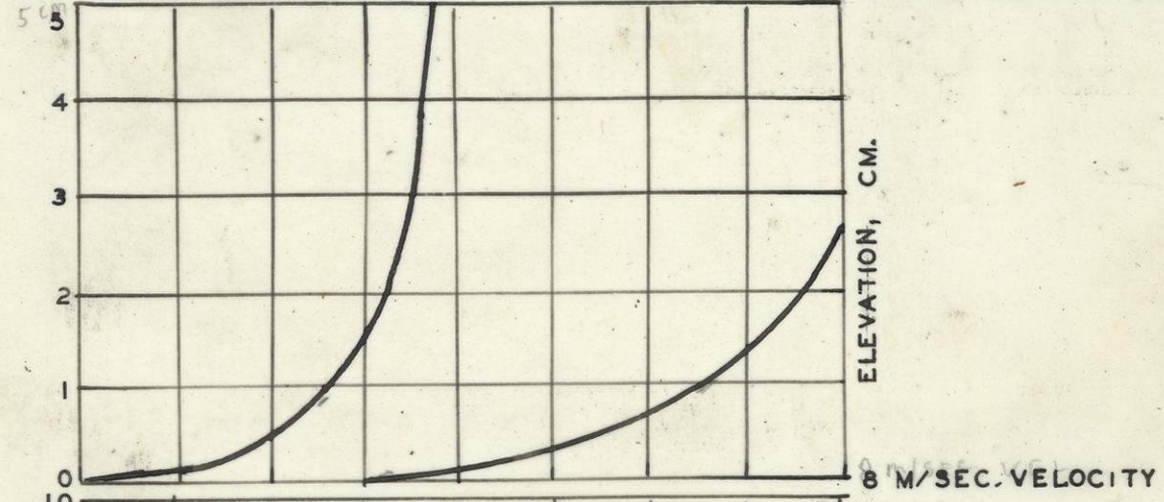

15.3

15.3

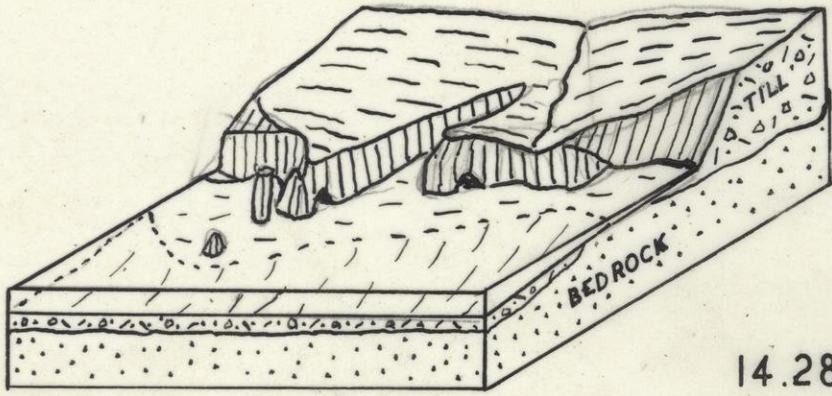

14.28 ✓

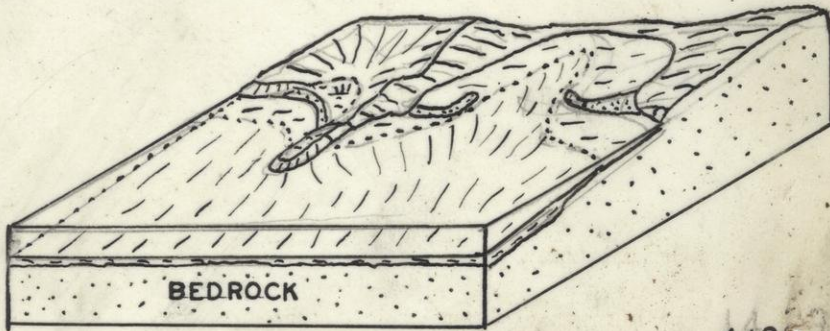

412

1412

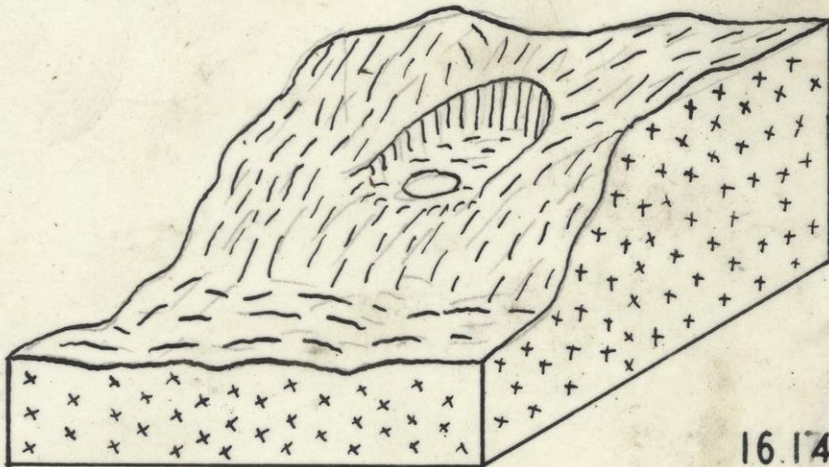

16.14

1614

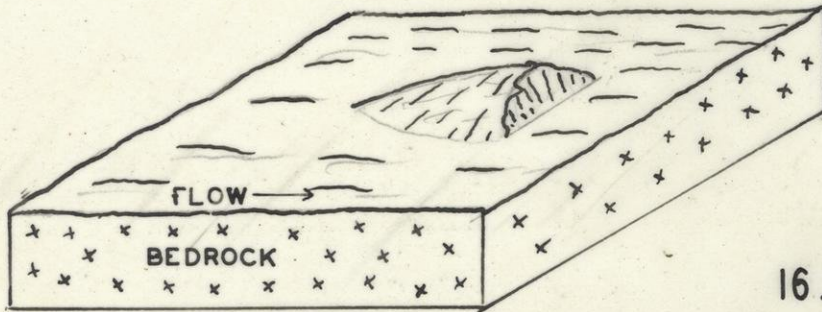

16.13
16-14

16.13

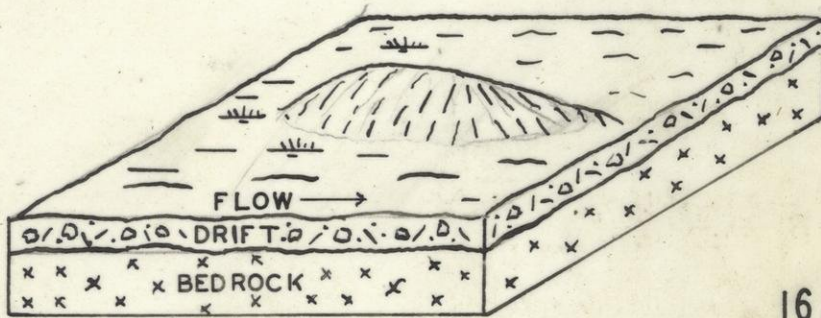

16.17

15

16.17

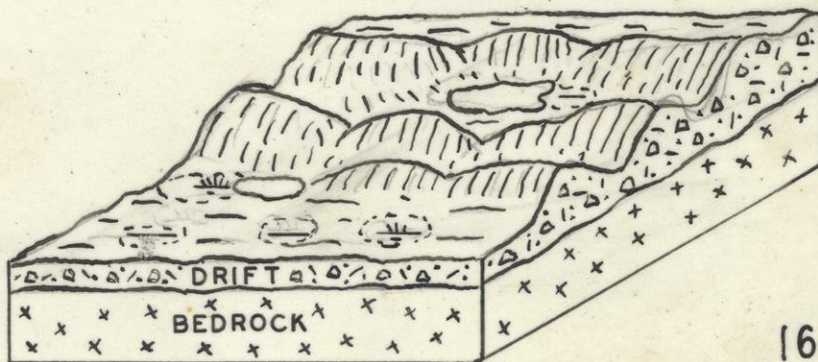

16.16

16

16.16

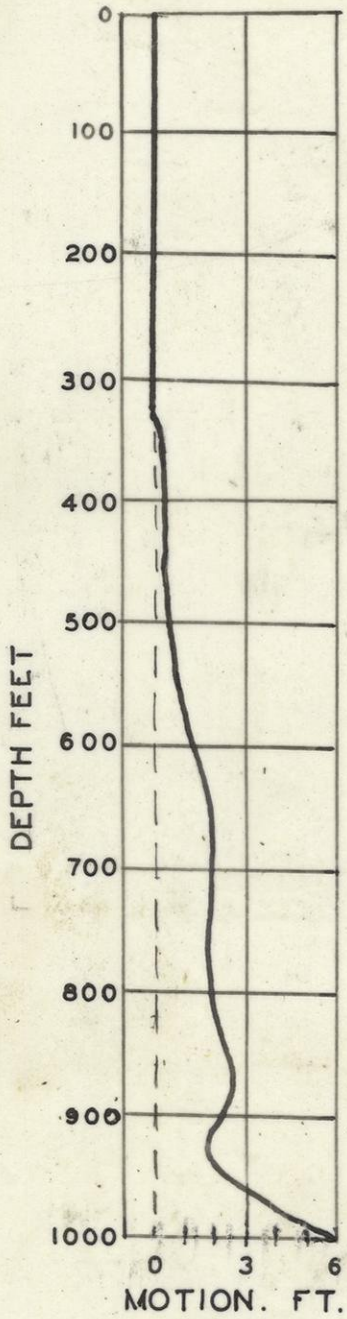

← FLOW
16.8

16.8

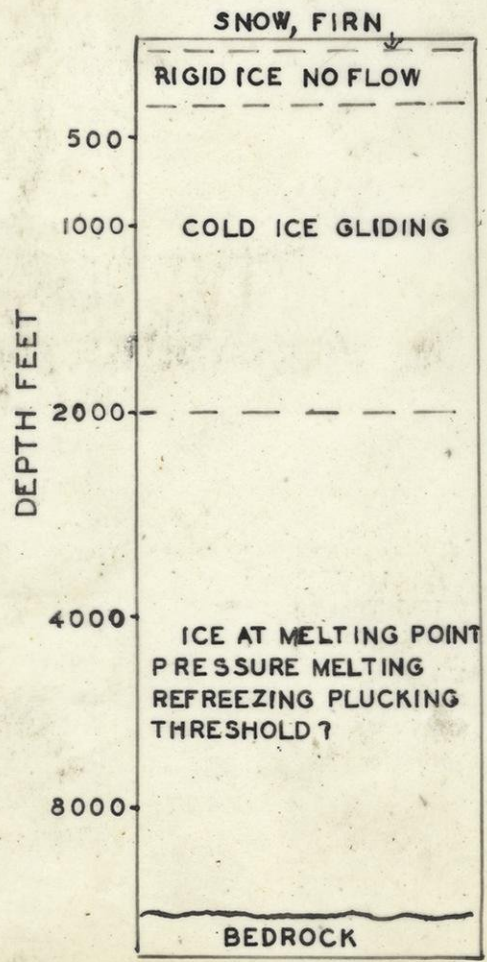

16.11

16.12

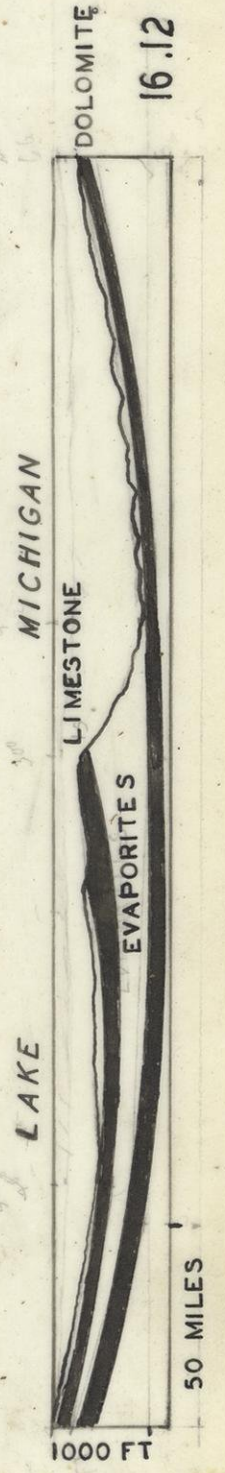

16.12

16.11

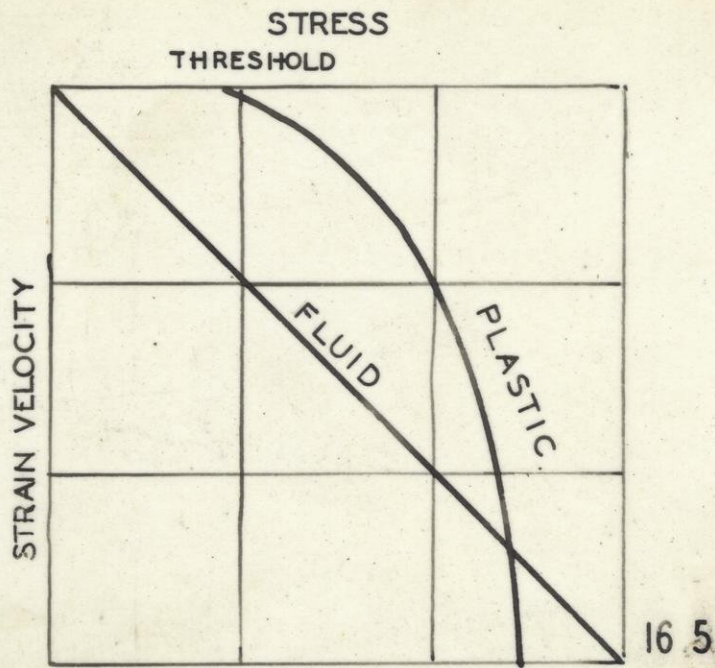

16.5

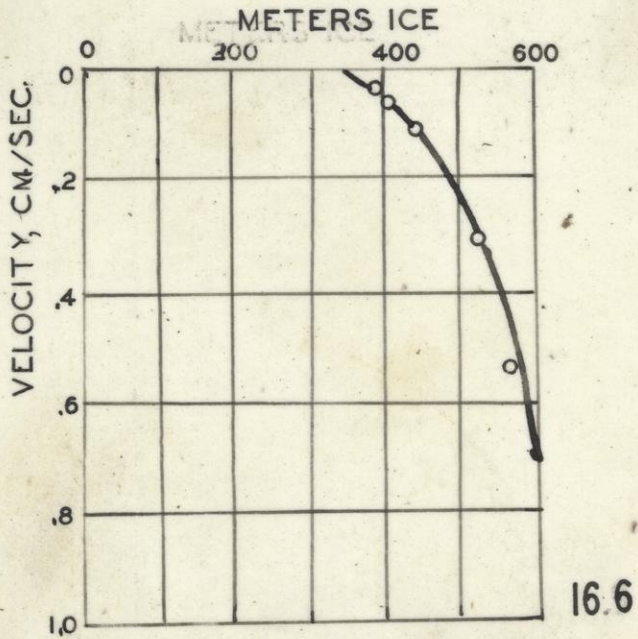

16.6

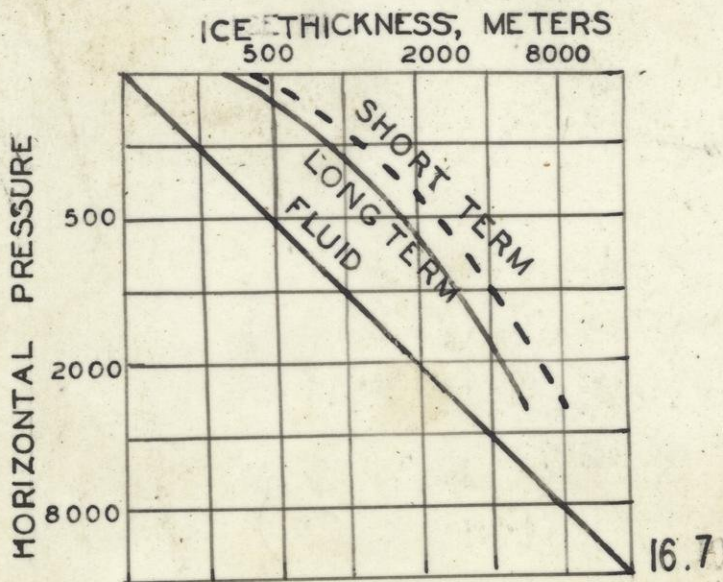

16.7

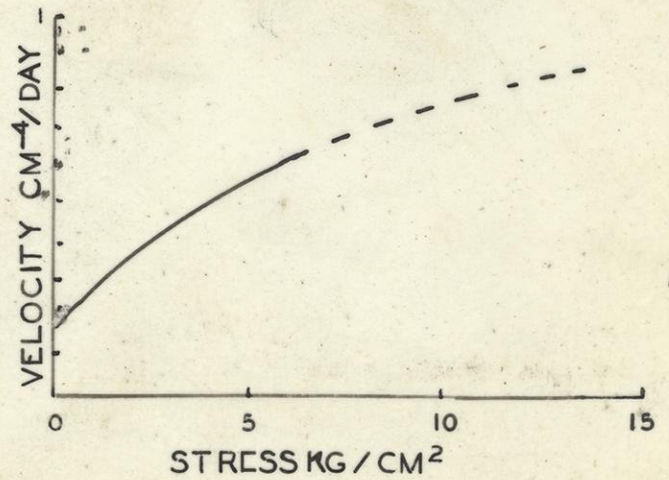
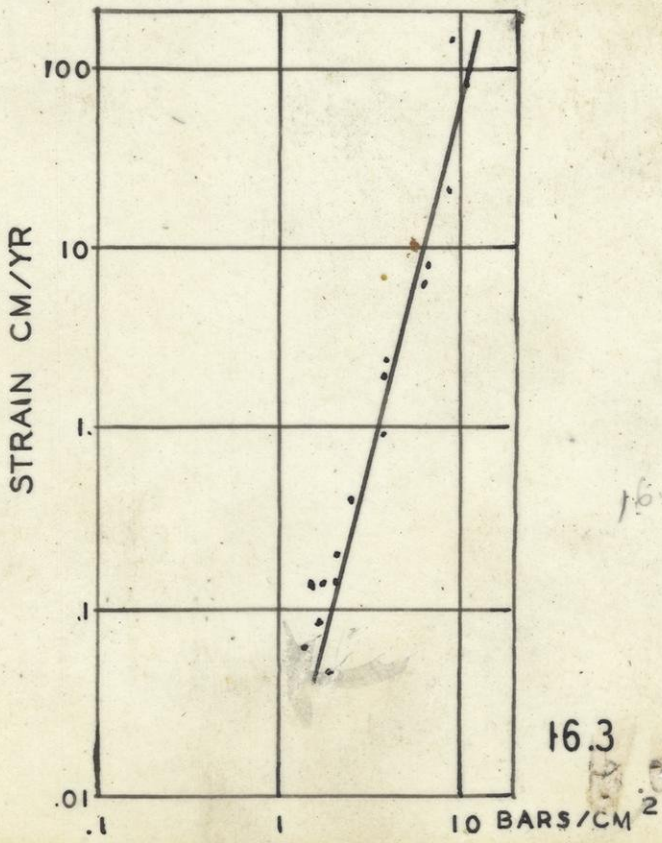
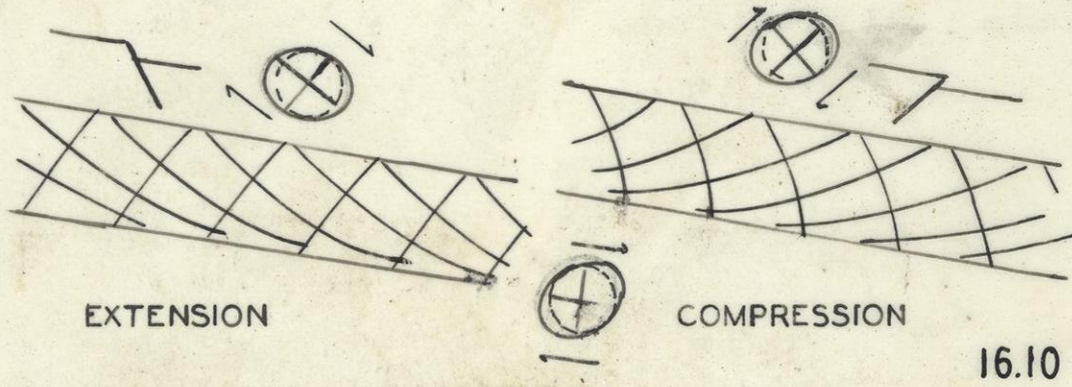
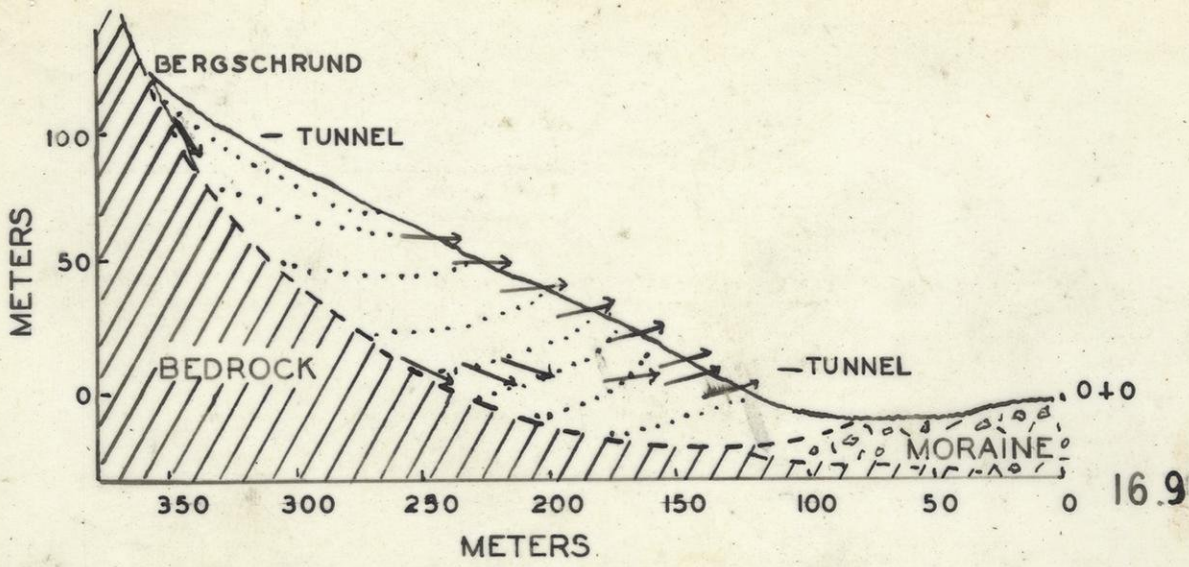

16.3

16.4

SEASONAL CONTROL
CONDUCTIVITY CONTROL

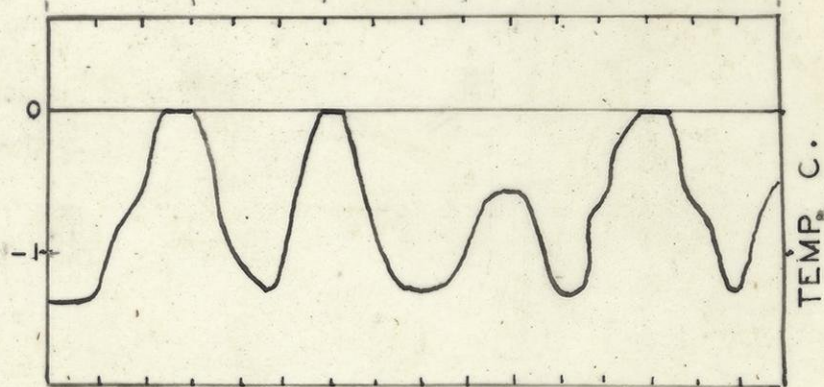
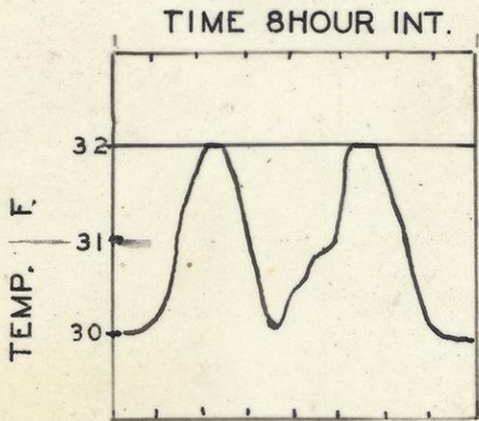
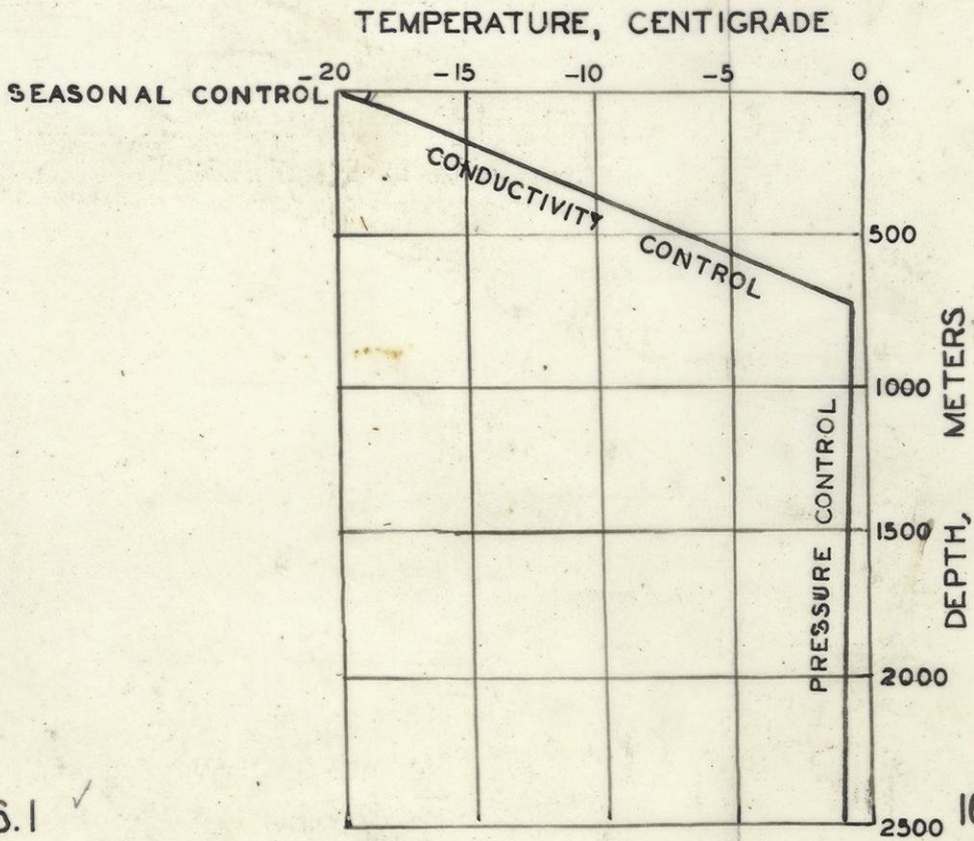
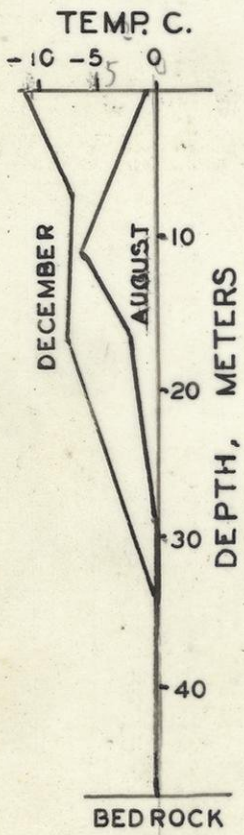

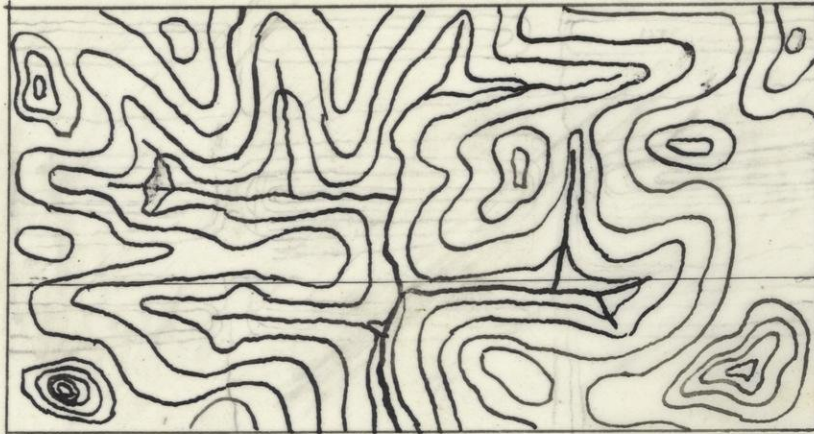

MAP

17.1

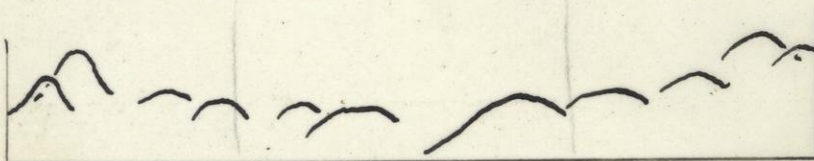

HILL TOPS PROJECTED



SKYLINE OF STRIP

17.2

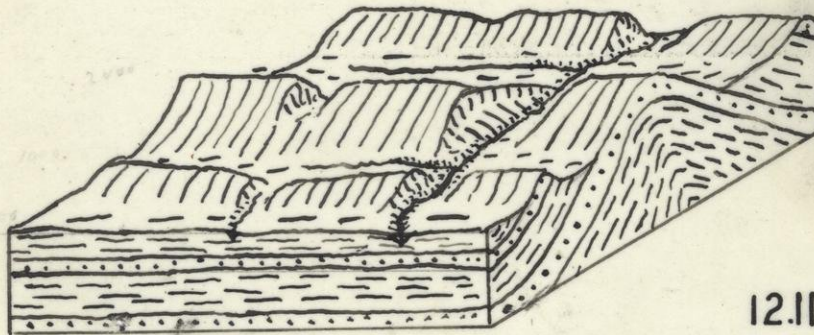

12.11

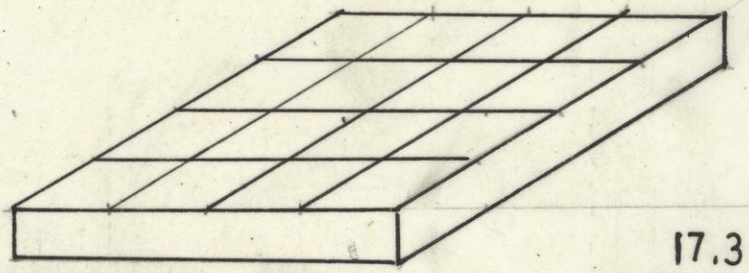

17.3

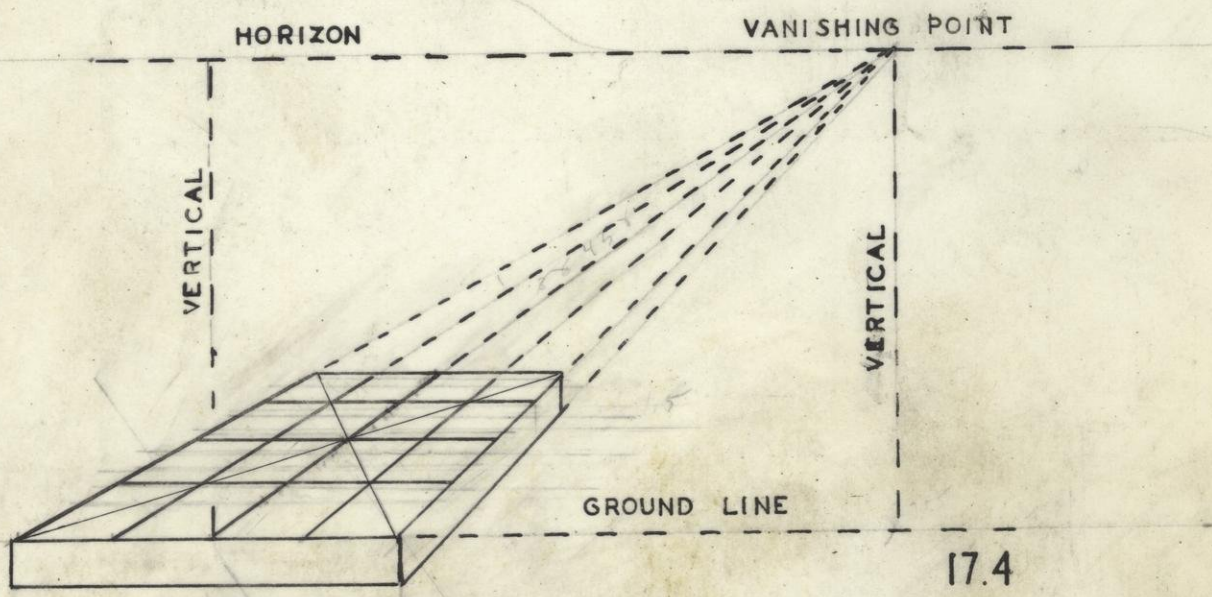

17.4

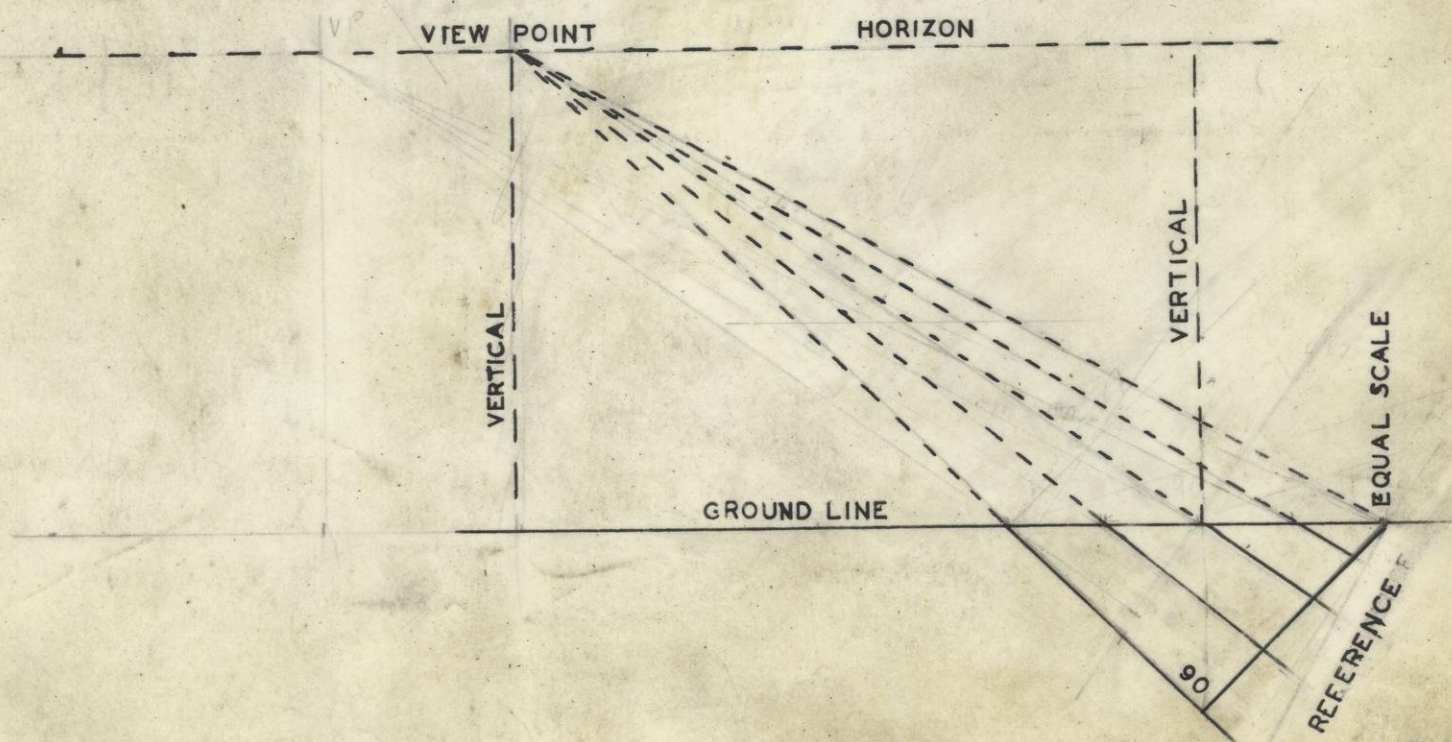

17.5

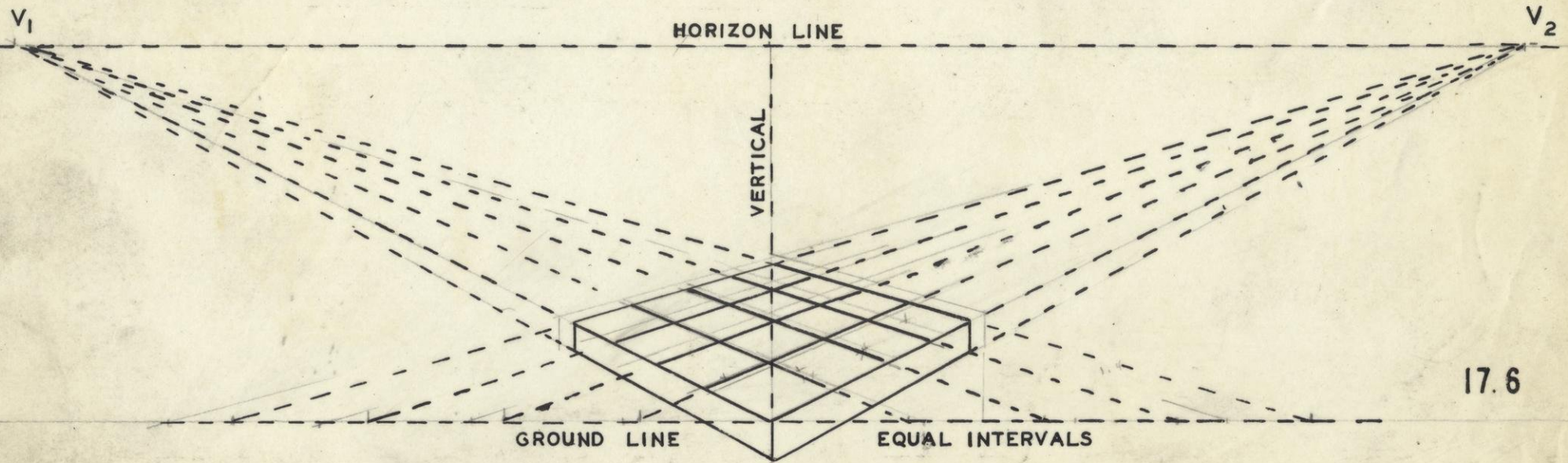

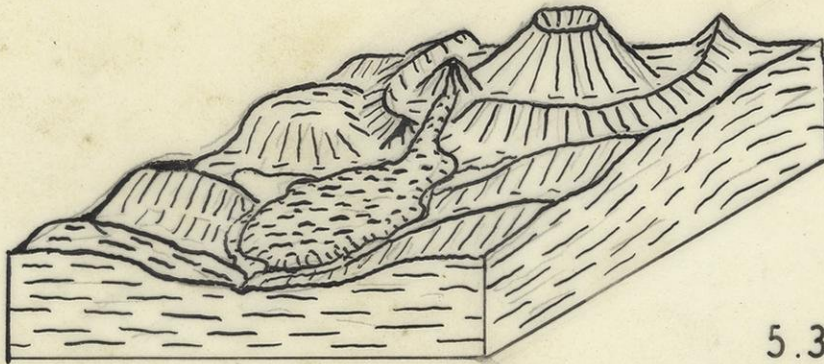

5.3

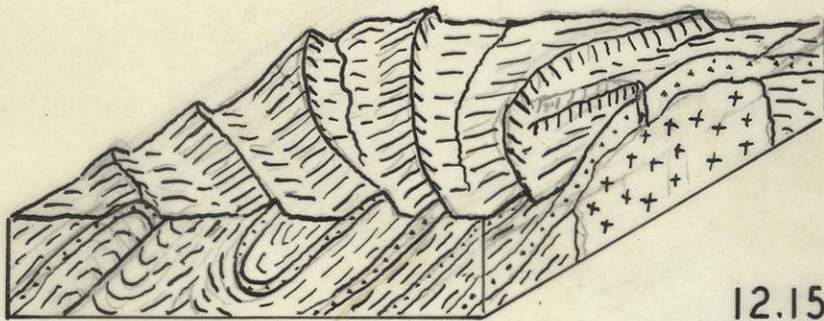

12.15

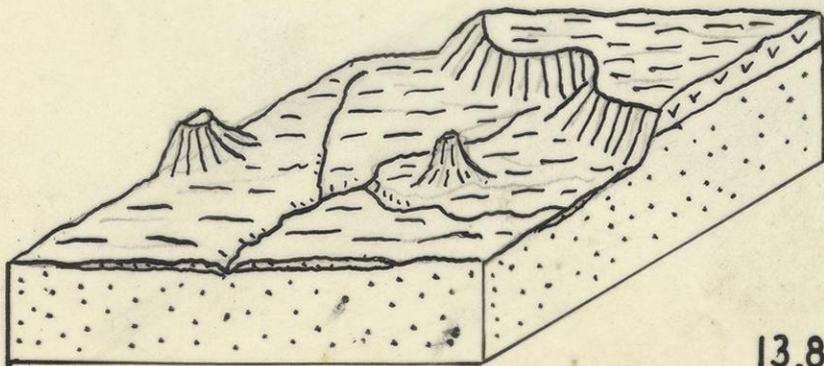

13.8