



LIBRARIES

UNIVERSITY OF WISCONSIN-MADISON

The Wisconsin engineer. Vol. 24, No. 4 January 1920

Madison, Wisconsin: Wisconsin Engineering Journal Association,
[s.d.]

<https://digital.library.wisc.edu/1711.dl/7P3DBZ6M5SIJV8I>

<http://rightsstatements.org/vocab/InC/1.0/>

The libraries provide public access to a wide range of material, including online exhibits, digitized collections, archival finding aids, our catalog, online articles, and a growing range of materials in many media.

When possible, we provide rights information in catalog records, finding aids, and other metadata that accompanies collections or items. However, it is always the user's obligation to evaluate copyright and rights issues in light of their own use.

Office Copy -

*Issued Jan 21
1920*

The Wisconsin Engineer

VOL. XXIV.

JANUARY, 1920

NO. 4

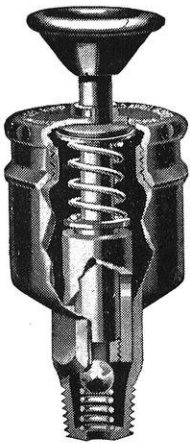

**Model H Vertical
Oil-Kipp**

Oil-Kipps are made in two models, vertical and horizontal. By means of adapters all cars can be equipped.

How Motors Are Being Perfected

A year ago it hardly seemed possible that four cylinder tractor motors could be greatly improved by the modifications of one single element.

But it has now been plainly proved that there is a way of reducing their oil costs by more than three-fourths, and increasing their maximum operating loads by more than 15%.

During the last year a series of comparative tests on a four cylinder motor have been conducted, to determine the increase in motor-merit attained with the Madison-Kipp Fresh Oil System—using oil but once.

The many tests made with the motor showed that, when it was Kipp-Equipt, it used 83% less oil than formerly.

Its operating load on kerosene was more than 15% greater than with used oil lubrication.

It showed a saving of over 10% in fuel consumption per brake horse-power hour.

Similar results have for years been demonstrated in the field on two-cylinder tractor motors.

In these days of keen need for lowered operating costs and reliable power, the perfection effected by fresh oil lubrication is especially attractive.

MADISON-KIPP CORPORATION
Madison, Wisconsin.

Madison-Kipp Lubricators

Fresh Oil Systems

PROM JEWELRY

Let us fit you out with a nice line of full dress jewelry
Dress suit sets, consisting of LINKS, STUDS,
and VEST BUTTONS.

LAMBOLEY, *The Jeweler*

220 STATE STREET

PHONE: BADGER 1102

The University Pharmacy

Corner State and Lake Streets
MADISON, WISCONSIN

Drugs, Sodas, Sundries, Student Supplies
— Prescriptions —

Only Registered Pharmacists trained at the University of Wisconsin
fill your prescriptions.

H. W. LEONARD, 1911

L. D. STEPHENSON, 1910

Sumner & Cramton

Roll films purchased of us
developed FREE!

DRUGS, STATIONERY, TOILET
SUPPLIES, ETC.

U. S. Postal Station No. 9



Chicago Steel Tape Co.

6231 Cottage Grove Ave.
CHICAGO, ILL.

—Manufacturers—

Surveying Implements, Tapes, Level-
ing Rods, Self-Computing Rods,
Stadia Rods, Rod Ribbons,
Targets, Marking Pins, Lin-
ing Poles, Eureka Tape
Repairers, Etc., Etc.



Zilisch Pure Milk Co.

Telephone Oakwood 979

Established 1854

CONKLIN & SONS COMPAY

COAL, WOOD AND MENDOTA LAKE ICE
Cement, Stucco, White Lime, Hair and Sewer Pipe
Main Office: 24 East Millin Street

Kindly mention The Wisconsin Engineer when you write.

MEMORY'S FAITHFUL ALLY

Pictures always tell the story better and quicker than words.
Bring us your Photo Finishing today and get it at noon tomorrow.
Remember: We offer 50% off on all your social function pictures.

UNIVERSITY PHOTO SHOP

807 University Avenue

Phone: Badger 6216

Volume 24

Founded 1896

Number 4

The Wisconsin Engineer

\$1.00 a Year

15c a Copy

Subscriptions, payable before February 1, \$1.00 a year in United States, Porto Rico, Hawaii, the Philippines, Cuba, or Mexico; \$1.25 in Canada; and \$1.50 in other countries. Copyright 1919 by the Wisconsin Engineering Journal Association. Any article printed herein may be reprinted provided due credit is given. Entered as second class matter Sept. 26, 1910, at the post office at Madison, Wis., under the Act of March 3, 1879. Acceptance for mailing at special rate of postage provided for in section 1103, Act of October 3, 1917, authorized October 21, 1918.

Published monthly from October to May, inclusive by
THE WISCONSIN ENGINEERING JOURNAL ASSOCIATION,
306a Engineering Building, Madison, Wisconsin
Telephone University 177

BOARD OF DIRECTORS

- L. F. VAN HAGAN, Associate Professor of Railway Engineering,
Chairman.
F. E. VOLK, Assistant Professor and Librarian of College of Engineering,
Secretary and Advisory Editor.
J. G. D. MACK, State Chief Engineer of Wisconsin.
E. BENNETT, Professor of Electrical Engineering.
O. L. KOWALKE, Professor of Chemical Engineering.
G. L. LARSON, Associate Professor of Steam and Gas Engineering.
R. S. MCCAFFERY, Professor of Mining and Metallurgy.
W. J. RHEINGANS, *Manager.*
C. A. WIEPKING, *Editor.*

STAFF

- WILLIAM J. RHEINGANS, c '20, *Manager*
CHRISTOPHER A. WIEPKING, c '20 *Editor*
W. EDWARD BLOWNEY, e '20, *Associate Editor*
D. W. NELSON, m '20 P. K. SCHUYLER, c '20
F. H. CIRVES, ch '21 J. B. HAMBLIN, ch '21
H. M. COOMBER, m '21, *Circulation* B. E. JAMES, m '21
W. E. ERICKSON, ch '21 A. P. GERHARDT, m '21
W. A. KATES, e '21, *Alumni* F. A. BUESE, m' 21
M. A. HIRSHBERG, ch '22 W. C. THIEL, c '22
F. W. NOLTE, e '22 W. D. TRUEBLOOD, ch '22, *Campus*
O. A. ROVE, c '22 J. E. WALSH, c '22

Kindly mention The Wisconsin Engineer when you write.

Slide Rules

Polyphase — Duplex — Mannheim — Phillips

The CO-OP

E. J. GRADY, Manager

508 State Street

Phone: Badger 2720

|| Thesis, Photo Copies and Printing ||

We can make photo reproductions from any drawing, sketch, etc., or make photographs of laboratory experiments, models, etc.

Ask us for suggestions and prices

The **P** **HOTOART**
HOUSE

WM. J. MEUER, PRESIDENT

HALF IS A PLENTY.

“Daddy,” said Bobby, who was eating an apple, “what would be worse than finding a worm in this apple?”

“I do not know, son, unless it would be to find two worms.”

“No,” said Bobby. “It would be worse to find half of a worm.”

“MADISON BLUE”—A mark of quality on Blue Prints or Rectigraph Prints

Madison Blue Print Company

PHONE 834 28 W. MIFFLIN

Scene: Student's Room. * Time: 10 P. M.

First slip-sticker: (Drawing long breath) Boy—That was some problem.

Second slip-sticker: (Grabbing hat and coat) I check you old man; but we got it. Now let's celebrate with one of “Dad's” malted milks.

State St. **MORGAN BROS.** State St.

Kindly mention The Wisconsin Engineer when you write.



J. L. KLITSNER
OPTOMETRIST and JEWELER

218 STATE ST.

When in need of **Glasses** consult us. We carry the
Largest Optical Stock in this city. Most
Modern Refracting Room.

Phone: Badger 3165.

CONTENTS

The Fundamental Principles of Safe Guarding.....	139
Protect Your Tools from Rust.....	147
Meter-Liter-Gram for the U. S. A.?......	148
A Practical Blue-Print Protector.....	153
Movies—The Painless Educator	154
The Fatigue of Metals.....	156
Why Memorizing is Essential to Thinking.....	157
Successful Wisconsin Engineer.....	158
Editorials	159
Alumni Notes	163
Campus Notes	166

UNIVERSITY Y. M. C. A. CAFETERIA

740 LANGDON STREET

CITY Y. M. C. A. CAFETERIA

207 W. WASHINGTON AVE.

Places of Wholesome Food and the Best of Service.
A large variety of the finest foods at moderate prices.

ALL THE NEW MUSIC AT HOOK BROS.

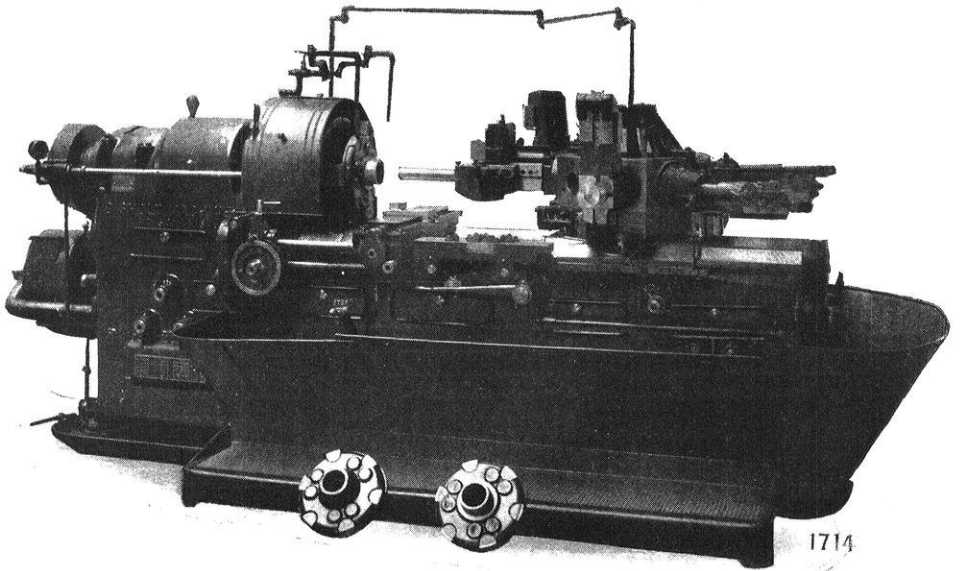

Increasing Production the Automatic Way

The Gisholt Automatic Turret Lathe was developed for handling heavy chucking work in large quantities.

The cut above illustrates the machine at work on a differential casing in the plant of a large automobile manufacturer.

Visit our works and see this machine being built as well as in operation.

Gisholt Machine Co., Madison, Wis.

Eastern Sales Office:
30 Church St., N. Y.

Works:
Madison, Wis., Warren, Pa.

GISHOLT PRODUCTS

Turret Lathes
Automatic Turret Lathes
Vertical and Horizontal Boring Mills
Universal Tool Grinders
Reamers, solid-adjustable
Boring Bars—adjustable cutter
Tool Post Tool Holders
Periodograph—for time recording in factories

Kindly mention The Wisconsin Engineer when you write.

The Wisconsin Engineer

VOL. XXIV.

JANUARY, 1920

No. 4

THE FUNDAMENTAL PRINCIPLES OF SAFE-GUARDING.*

By SIDNEY J. WILLIAMS, C '08, CE '15
*Secretary and Chief Engineer, the National Safety Council,
Chicago*

The first half of our subject is—what shall I guard? The second half is—how shall I guard it?

If you want your plant to be 100 per cent safe, the answer to the first question is—guard every moving part, wherever located, on which a workman might be injured if he came in contact with it in any way or from any cause whatsoever. If the moving part is in a place “where nobody ever goes” remember that some one is likely to go there sooner or later, in connection with the repair or maintenance or alteration of the machinery itself or of the building, or for some other reason which you cannot anticipate. You probably have heard the classic story—a perfectly true story—of the man whose heel was cut off by an unguarded gear 14 inches below the ceiling. The man was standing on a scaffold, working on another shaft nearby; to brace himself he placed his foot against the shaft on which the unguarded gear was located. His foot slipped, and was caught in the gear. Many similar examples could be quoted of accidents occurring in out-of-the-way places. Recognizing this fact, the Illinois Steel Company rule-book—to mention only one example—requires that all gears, wherever located, must be enclosed.

You may be puzzled by attempting to apply this principle to the guarding of overhead shafting and belts. Many plants contain miles of overhead shafting which it is almost a physical impossibility to guard. On the other hand, oilers and repairmen are frequently injured, sometimes fatally, on unguarded overhead shafting or belts. The only solution is, if the shafting pos-

*Presented at the A. B. C. Session, Eighth Annual Safety Congress, Cleveland, Thursday Morning, October 2, 1919.

itively cannot be guarded, to prohibit absolutely any work on such overhead transmission while it is motion. Repair work, shortening of belts, etc. can be done during the noon hour or at night; oiling likewise—or better still, install automatic oilers or oilers which can be filled from the floor by using a special oil can with long spout. For details, see the National Safety Council's Safe Practices pamphlet on this subject.

A gear or belt or other dangerous moving part which happens to be located below a table, or in some other place where it is partially hidden, is not thereby made safe. Someone occasionally must reach under the table to sweep or repair the floor or oil or repair the machine. Someone may slip or stumble so that his arm comes in contact with a gear or belt which would be safe for the workman standing in his normal position. The immigrant totally ignorant of machinery—and it is hard for us to realize the completeness of the ignorance on this subject on the part of foreigners brought up in farming districts—may deliberately put his hand or his finger into an opening that looks interesting, just to see what it is. If he finds that “it” is an unguarded gear, it is easy to say that the accident is his own fault; but that does not relieve our obligation to pay his compensation nor does it restore him to his vacant place in the gang.

What I have said of gears and belts applies equally well to any moving part on which a man might be injured—counterweights, cranks, reciprocating parts such as a planer bed, and so on; also, of course, to the operating point of machines.

The second half of the problem is—as already stated—“How shall I guard it?” Here are a few points to remember:

1—A safeguard shall be so designed and constructed that it will prevent *all* accidents on the part guarded—not only accidents to the operator while at his regular work, but also to the operator or passers-by in case they slip or fall or carelessly touch the machine.

2—The guard should not interfere with production. If it does, it is liable to be taken off. In designing a guard it is generally wise to consult the man who will use it.

3—In general, the guard should be attached to the machine and not to the floor; if attached to the floor, use a connection which will interfere as little as possible.

4—The guarded part must be easily accessible for oiling, inspection, and repair. The door or removable section for this

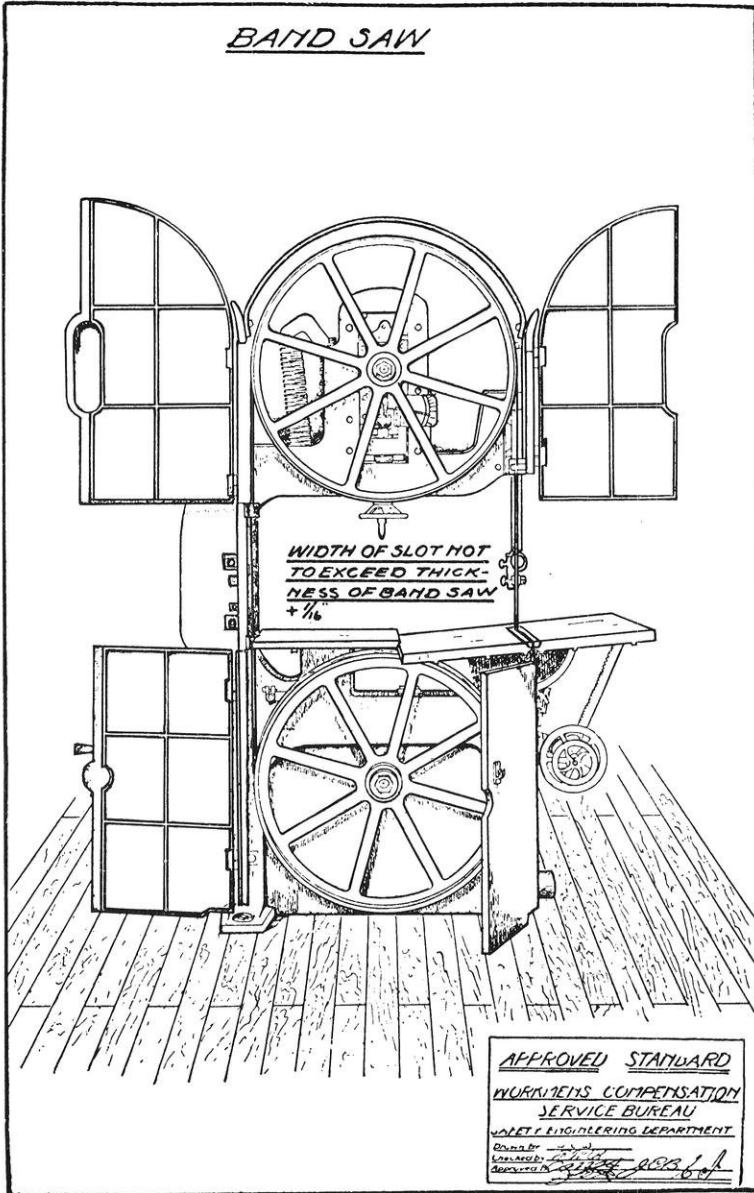

BAND SAW WITH CASE OPEN.

purpose should be hinged or otherwise attached to the remainder of the guard, or to the machine. If not, it is likely to be left off permanently.

5—The guard should not interfere with cleaning and sweeping around the machine. It should, therefore, be kept generally about six inches above the floor.

6—The guard should be strong enough to resist injury and keep its shape. A light, flimsy guard soon becomes bent and is discarded. A substantial guard is cheaper in the end.

7—Incombustible guards are preferred. Wooden guards, soaked with oil, may become a serious fire hazard. Metal guards are neater and wear much better. "Metal guards look as if you wanted to; wooden guards look as if you had to." Guards may be made of cast iron, sheet metal, wire mesh, expanded or perforated metal, or slats. Where subjected to acid or fumes, wooden guards may be necessary.

8—It is desirable to interlock the guard with the operating mechanism, where possible, so the machine cannot be operated unless the guard is in place.

9—A safeguard can often be so designed that it will also serve to prevent wear on the parts guarded—for example, a solid gear enclosure.

Let us consider the application of these suggestions to the design of gear guards. Cast iron guards are preferred because they may be made to fit more snugly, present a better appearance, and protect the gears from dust and injury. In shops having similar gears on several machines, the cost of patterns and cast iron guards will be no greater than the cost of "built-up" guards. A cast guard of one machine may be used as a pattern for making guards for similar machines.

Guards for a variety of machines, and in many sizes, may be more cheaply made of sheet metal. In large guards, an angle iron is used to make the joint between the flat sides and the curved part of the guard. In smaller guards this joint may be made by cutting projections (like saw teeth) on each side piece and bending these over to form a smooth curve. The joint may then be made either by spot welding or by riveting. Short pieces of angle iron may also be used to form the joint—about $\frac{3}{4}$ " \times $\frac{3}{4}$ " \times $\frac{1}{8}$ " angles, one inch long, 3" or 4" apart.

Gears should be completely encased; or where this is impracticable, should have a band guard with side flanges extending in-

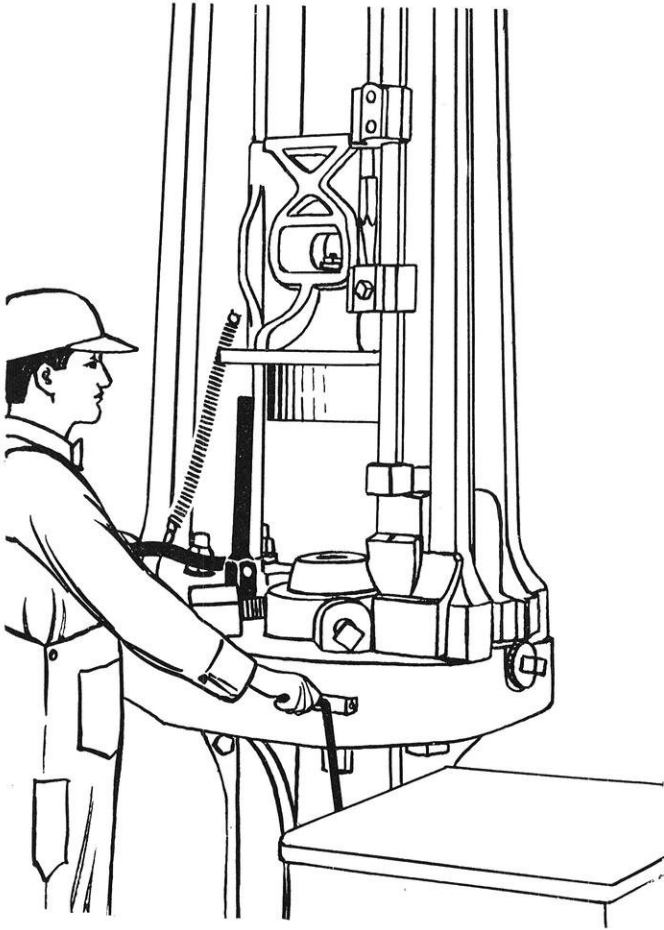

DOUBLE SAFETY TRIP AND NON-REPEATING DEVICE FOR PUNCH PRESS AND DROP HAMMER.

ward beyond the root of the teeth. If there is a spoke hazard, the gear should be completely enclosed, or filled in between the spokes.

Belts, flywheels, shafting, and large gears are often guarded by an open work rather than a solid enclosure. Such guards should be so designed that no one can get his hand or his finger into the danger point even if he tries. If the guard comes within four inches of any danger point the opening should be not greater than one-half inch square, which is small enough to ex-

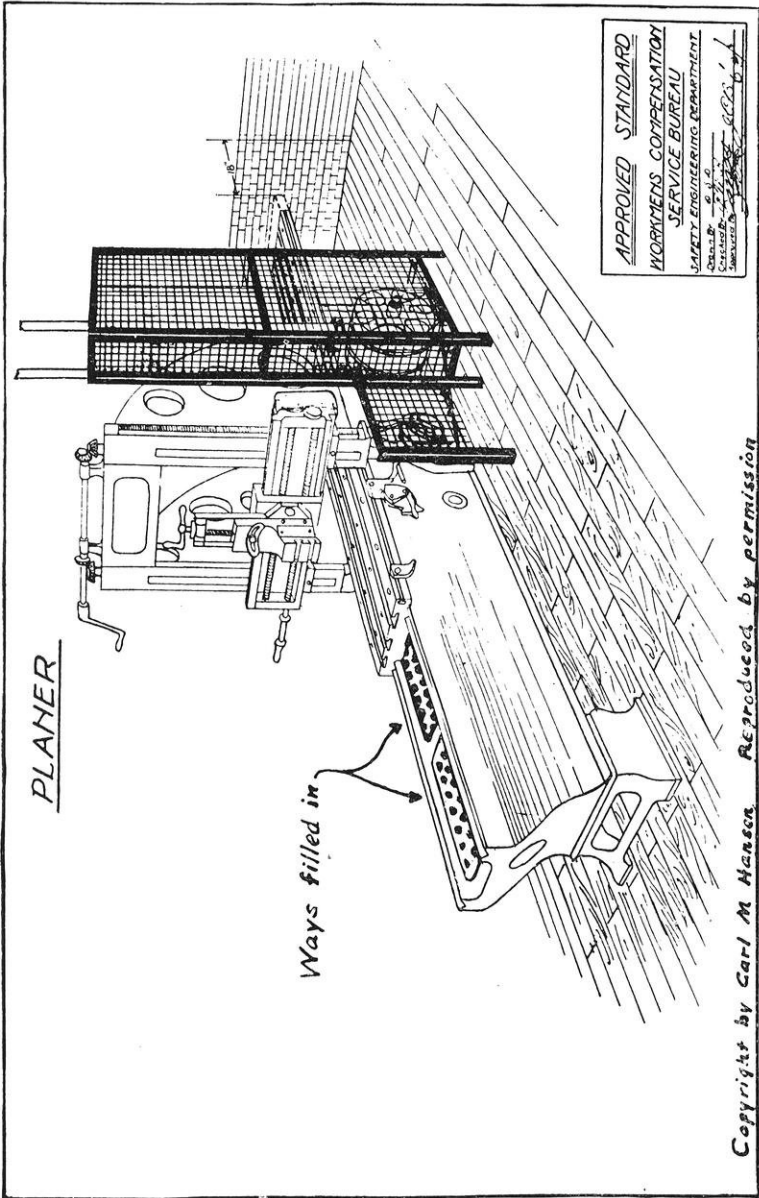

Copyright by Carl M. Hansen. Reproduced by permission

PLANER WITH GEARS ENCLOSED.

clude fingers. If more than four inches away—which is about the maximum length of a man's finger—the openings may be larger than one-half inch, but not larger than two inches square this being small enough to keep out a man's hand. If a slatted construction is used the slats should not be more than one inch apart.

The safety engineer's greatest difficulty is in guarding machines on which men are working. Let me repeat that it is very important not to attempt to guard machines in a way which will interfere with production. The great majority of both foremen and workmen will seriously object to such a guard, will use it under protest and when the opportunity arises they will take it off and not put it back. I have time to mention only two examples—the circular saw and the punch press.

A guard is not the only essential for safety in operating a circular saw. For ripping, it is very important that the saw be provided with a splitter. Keeping the saw sharp and properly set will greatly decrease the danger of throwbacks. The floor where the operator stands should have a nonslip surface.

Many shop men say that it is impossible to guard a circular saw without interfering seriously with operation. The safety rule book of a large company contains a similar statement. In a great majority of the woodworking shops which I have visited, some, at least, of the saws have not been guarded or some of the guards have not been in use.

I remember, however, two woodworking shops where every saw was guarded and every guard was in use—the Westinghouse Electric and Manufacturing Company, at Pittsburgh, and the Commonwealth Steel Company at Granite City. There doubtless are others but I do not happen to have seen them. In each of these two shops every circular saw was provided with a guard which completely covered it when not in use and which rose automatically from the table as the stock was inserted. I watched men operating these saws and the guards did not seem to introduce the slightest difficulty. They were of very light construction and when the stock was shoved in they rose without apparent effort,—the larger ones, at least, being counterweighted. The men in charge of these departments told me that the guards did not interfere at all with production, and in fact that the men now would not work without them because they felt that they

were so much safer. I do not blame the workman or the foreman who objects to using a cumbersome, heavy, non-adjustable guard.

Special work on circular saws sometimes is difficult to guard. In some cases, these difficulties may be overcome by careful study. In a few cases they probably can not, and the guard must be temporarily laid aside, being hinged or pivoted for that purpose. Where this must be done, another safeguard can often be introduced. For example, in grooving the edge of a board, provide an auxiliary guide or fence, so that there will be a guard on each side of the saw, thus keeping hands away from contact with it.

The punch press—using that common term to include all kinds of power presses—has, with the circular saw, the doubtful honor of causing more injuries, and especially more permanent injuries, than any other kind of machine. Where possible, the best guard is an enclosure around the plunger, which makes it impossible to get one's fingers underneath. Often, however, this is impossible. In such a case, let me suggest that instead of buying a dozen or a hundred of some so-called safety device, and putting it on every punch press in the shop, you start with one individual press and study the operation carefully in cooperation with the superintendent, foreman, master mechanic, and operator of the machine. Ask yourself the question—why do accidents happen or why may they happen on this particular press? The answer will be that, for one reason or another, the operator finds it necessary or convenient to put his hand under the plunger—either regularly or occasionally. The way to make the operation safe, then, is to arrange it so that the operator need not and will not put his hand under the plunger. Some times this may be done by cutting away a portion of the dies so that the operator can keep hold of a part of the piece being formed and still not be injured. Often it may be accomplished by introducing an automatic or a foot-operated kick out. This almost always increases production as well as safety. Sometimes it is found practicable and advantageous to interchange the upper and lower dies. Sometimes the method of operation may be altered; I have in mind one case where, in riveting the handle socket onto a kettle, the operator laid the rivets in position after the kettle was in the machine and sometimes the plunger came down and caught her finger. After a good deal of study the superintendent arranged to have another girl place the rivets in position and

hand the kettle to the operator, who then placed it in the press and completed the operation, obviously without danger and obviously with a great saving in time as well. In a great many cases, where the same operation is continued for a long time on one press, it will be found economical to provide some sort of automatic or semi-automatic feed; this also always increases production as well as removes the hazard. Gate guards and two handed operations are sometimes necessary, but should be used only as a last resort. The methods above are more efficient because they go to the root of the matter and remove the hazard rather than merely guarding it. When you remove the hazard you simplify the operation and therefore increase production. When you merely guard the hazard you may decrease production.

What I have said of the punch press is typical of many machines. Safety engineering does not consist in simply building wire mesh guards, nor in buying safety devices which look pretty in a catalog, and putting them on the machine without regard to the wishes, the convenience, or the efficiency of the operator. The real safety engineer will, where necessary, study the operation of a machine until he understands it as well or better than the operator himself—as well as the foreman, the superintendent, the master mechanic; and then he will apply their brains and his own in working out either a guard, or a change in the machine, or a change in the operation, which will remove the underlying hazard and make the operation intrinsically safe.

PROTECT YOUR TOOLS FROM RUST.

Probably the best tool protector and carrying case for a small kit may be made in the shape of a roll from a piece of pyroxylin coated fabric having a napped or fleecy back. This material is thoroughly waterproof and if care is taken in wrapping the tools in it after use, it will prevent moisture from reaching them and no damage from rust can occur.

The material is durable and will last a long time. It is obtainable at many department and general stores where it is sold under the general name of leather substitute. There are many leather substitutes on the market sold under various manufacturers' trade names. Practically any of them will answer very nicely for the use specified.

—*DuPont News Service.*

METER-LITER-GRAM FOR THE U. S. A.?

By MONTROSE K. DREWRY

Sophomore Mechanical

Shall the inch soon pass into oblivion in favor of its smaller opponent, the centimeter? Shall the pound give way to the kilogram? Shall the quart follow the others and be displaced by the liter? In other words, will our progressive nation, now entering its greatest industrial era, decree that the present antiquated system of weights and measures be junked, and that the metric system be the only lawful standard?

Should the change be made? At the suggestion of a change so radical, conservative minds, foreseeing confusion and possible heavy loss in money, material, and time, draw back. Those of us who have worked in large industrial plants have marvelled at the enormous stores of gages, jigs, and other tools and fixtures that are used in manufacturing. Would it be good business to scrap all these together with many machines, as it seems necessary to do? Wouldn't the time lost by the factories during the process of shifting in itself be a prohibitive factor?

The question is a big one and a vital one. The United States is frankly competing for world trade and a great part of the world, particularly in this hemisphere, uses the metric system. Our decision must be based, not upon our own personal whim, but upon considerations of efficiency and with a view to our neighbors' opinions.

The metric system, a product of the ingenuity of James Watt, the world's greatest engineer, was intended to furnish a standard decimal system to supplant the multitude of local systems that Europe then used. France, seeing its merits, quickly adopted it, as have thirty-three other nations; but England and the United States, for a few very poor reasons, still use the many "Dark Age systems," as they have been quite correctly called.

Contrary to the general opinion, the systems used in England and in this country are not the same. English and American gallons, tons, hundred-weights, bushels, and other units differ so appreciably that only exporters who are thoroughly experienced can trade between the two countries without confusion. Trouble arises periodically over border-line trading with Canada. Even in our own nation the standards of many states differ.

Some states legalize bushels, for instance, that are so radically different from those of neighboring states that sales must be made by weight alone. A resident of Philadelphia expects 2,240 pounds of coal to be delivered when he orders a ton of that commodity, while a buyer outside of that city's limits expects only 2,000 pounds. The users of the metric system recognize only one fixed amount for each unit. There are no parallels of the avoirdupois, troy, and apothecary weights; liquid and dry measures; and the many other equally confusing units of the English system. A kilogram is exactly 1,000 grams in Chile, Paris, or in any other place where the metric system is used.

The merits of the English system are, for the most part, mythical. There is no truth in the statement that the inch and its sub-divisions are the most convenient lengths for small measurements. The Waltham Watch Company, for example, found the converse to be true, and, at a considerable temporary loss, changed to the metric system. As to measurements from a centimeter to an inch and over, it cannot be said truthfully that the inch is more convenient than the centimeter. The only other important merit claimed for the English system is that the use of an inch scale is easier than that of the centimeter scale. It is claimed that any desired degree of accuracy can be obtained on an inch scale because each division, from the inch down, is one-half of the preceding division. A minute advantage might be apparent were the very fine points of the question discussed, but surely any merit in that direction is dwarfed when compared to even the second rate advantages of the centimeter scale.

The clumsiness of the English system is apparent to all who use it. Dr. Clyde Wolfe of the University of California states that if a decimal system were made obligatory in the United States, the teaching of arithmetic to a child would be shortened by two years. As our coinage system can be taught shortly after the child has mastered the numbers, dollar, meter, liter, and gram could be taught together, mutually reenforcing each other. It is of interest to know that our coins are metric products, and that a five cent piece, for instance, weighs exactly five grams, and, if comparatively new, it can be used with accuracy as a balance weight.

Since the units of the English system are not standardized between England and United States or even among our own

states and communities, and as the merits of that system are far inferior to those of the metric system, the only objection to changing to the metric system must be the difficulty of changing. It is only because of that objection that opposition to the adoption of the metric system can be maintained.

For the purpose of ascertaining the extent of the probable difficulties of changing units, Secretary of the Treasury, W. G. McAdoo, in 1916 requested the Director of the Bureau of Standards to furnish a report upon the certain phases of the use of the metric system in the United States. The report begins with a tabulation naming a few of the many manufacturers who are already using the metric system,—in some cases for both domestic and foreign trade. Among them are Brown and Sharpe, Bausch and Lomb Optical Co., Lufkin Rule Co., Kueffel and Esser, Eastman Kodak Co., Pratt and Whitney. A sub-note states that the list might easily be extended almost indefinitely.

From the experiences of the firms that are already using the metric system much can be learned of the difficulties of establishing it. An example cited in the report is the experience of the Baldwin Locomotive works, one of United States' largest manufacturers of locomotives. The company received from France an order for 100 locomotives to be built to metric units. It was decided to use the metric system from drawing room to assembling, and, accordingly, the plant changed immediately to the use of the new units.

"The adoption of the metric system for this and other orders," said the executive in charge of the works to a government representative, "did not cost a penny extra. Our mistakes were fewer and the loss of rejects less than on our regular line. The use of the system was indeed found to be easier in many respects, and we fill all orders for metric sizes of products in that system. It is the common-sense method and is no trouble at all."

To explain why the order did not cost "a penny extra," one need only to examine casually the catalogues of leading tool and scale makers. Nearly every article, as pointed out in the report, can be duplicated in the corresponding metric unit at the same price. Not only are all the necessary tools, gages, scales, and most other accessories of manufacturing immediately available in case of a change, but they may be purchased at the same price as that paid for renewal articles.

The statement of the company's official to the effect that the mistakes were fewer and the loss by rejects less when the metric system was used should have considerable bearing on anyone's opinion when considering the advisability of adopting it. It means that, although the change to an entirely different system was made "over-night," the extreme simplicity and the other good features of the system were sufficient, even under such a severe handicap, to give better results than a system that the workmen had used all their lives. To call the metric system "the common-sense method" is putting it correctly.

People opposed to the adoption of the metric system have made a considerable point of the necessity of remodeling or scrapping machinery. As an illustration they generally refer to the lead screw of a lathe, saying that the problem offered by that piece of machinery is a serious one. Although it does seem a large sized difficulty, one has only to learn that a 50-tooth and a 127-tooth gear, rigidly attached and inserted in the train of gears, makes the lathe ready to cut metric threads. The catalogues also offer another alternative by advertising metric lead screws which may be substituted for the original English system lead screws at the same price. Either method of correcting the lead screw difficulty, together with a substitution of feeding dials divided into centimeters, would equip most lathes for nearly all metric lathe work. The majority of other machines could be changed as easily as the lathe, for in nearly all cases the scales and dials are not permanently attached to the machine.

The Gisholt Machine Company, whose present location enables Madison to claim the fifth place in the machine tool manufacturing industry in the United States, provides all its products with metric attachments. Until recently it has offered a choice of either change gears or metric lead screws to the buyers in this country or abroad who desire lathes equipped for metric work. It has decided, however, that the cheaper way of solving the problem is fully as practical as the other, and accordingly it is now providing only change gears. Gisholt boring mills, which are known in all parts of the world, are fitted with metric dials and lead screw if so desired.

The greatest trouble in shifting to the metric system would not be experienced in changing machinery, as many people expect. The one big obstacle, to which all others are secondary,

will be the changing of *products*. It is the changing from one *model* to another that is to cause the greatest troubles. It must be done, for no way of averting the difficulty exists.

To understand why the changing of products will cause the most difficulty it is best to imagine the situation of the average American manufacturer during the process of shifting units. The experience of the Baldwin Locomotive Company that has been cited cannot be taken as one typical of the majority that would probably occur. The products of most manufacturers are built to specifications that are not altered appreciably for five, ten, and sometimes twenty-five years. It is not profitable, except in a few cases, to make radical changes in shorter periods. The illustration of the Baldwin Locomotive Company is one of the exceptions, for the buyers of the locomotives knew that they had to pay for the increased cost of production. The situation of the average manufacturer is entirely different. He has fixed models for each article produced, and all the drawings, patterns, jigs, and other manufacturing necessities are for those models only. It would be his problem, did our government make the metric system obligatory, either to convert all measurements into long metric decimals, keeping the same models, or to change the models so that all measurements could be expressed in reasonably short decimals. The first alternative would meet the problem temporarily. Eventually it would become impractical, for tools and other necessities could not be furnished him in the hundreds of odd sizes that he would require. The second choice, although by far the most expensive, would be, under certain circumstances, the most feasible. Were the model beyond the stage of experiment and were sales assured for a long period, it would undoubtedly be the wisest case to pursue. Due consideration, however, would need to be given to the troubles of furnishing repairs for the old models.

Overshadowing all of these pros and cons is the question of our future world trade. Germany wished world trade. She accordingly adopted the standard of weights and measures of the majority of other countries—the metric system—and obtained the trade. It is true that considerable losses were felt in changing, but they were negligible when compared to the ensuing gains. It is the present problem of *our* government to promote foreign trade, for it is upon that outlet that the advance-

ment of our industries depends. Only a policy of "Sell to Satisfy" can succeed. The foreign buyer is not satisfied with articles scaled in English units. His country uses metric units, and he will buy where he can get the products that he desires. Not until our government adopts the metric system will the trade problem be completely solved.

Knowing men of the day have said that the coming few years will be the crisis of the battle of measurements. Daily, as our industries grow, the tremendous problem of changing units grows larger. There is a limit to the time that we can wait, and if that limit be passed before action is taken, our nation will be forever separated from all others by a barrier of weights and measures.

A PRACTICAL BLUE-PRINT PROTECTOR.

Blue-prints are always getting dirty, wet, greasy or torn while being handled by workmen using them.

An inventive genius has designed a very practical blue-print protector of simple construction and low cost.

A sheet of transparent sheeting—the same material used for lights in auto curtains—is cut to desired size. A piece of light-weight leather substitute is then cut about a half inch larger all around than the piece of sheeting. This extra half inch allows for a lap-over on all but the top side of the protector. A sewing machine stitches the lap down to the sheeting forming a large flat pocket, open at the top for the insertion of the blue prints.

Both the transparent front and the coated fabric back are water-proof and grease-proof. Dirt or grease may easily be wiped or washed off either without injury to the material. Both materials are flexible and the holder may be rolled up if desired in the same way an unprotected blue print is usually handled by a workman.

DuPont News Service.



MOVIES—THE PAINLESS EDUCATOR

D. Appleton & Company, one of leading publishers of school and college textbooks, and the Educational Department of the Universal Film Manufacturing Company, have joined forces to make motion pictures a practical and important part of instruction in schools and colleges. This is the first comprehensive movement to put the ideal method of instruction into the schools in a big way. No educator questions that the screen method is the ideal method of instruction. Printed words, at their best, create only mental images; films are all images. Teacher draws diagrams; in films the diagrams come to life. The screen way is a painless method of education; films entertain while they instruct.

Harry Levey, managing director of the Industrial Department of Universal, predicts that, within a few years, eighty per cent of the schools in the United States will be using educational films to an extent people today little dream of. He holds that films are soon to revolutionize the entire system of education. Of course films will never supplant textbooks entirely anymore than warplanes supplanted infantry; but in years to come each will be used in conjunction with the other.

If motion pictures can teach arithmetic—and that they can has been demonstrated by no less authority than the Department of Education of the United States Government—then what can be done with subjects such as geography, history, botany, zoology, and physiology?

Geography classes can climb aboard the celluloid magic carpet and take trips to the very land about which they are studying. Text books describe how people of a land live; but, when the curtains are lowered over the classroom windows and the picture projector opens its fiery eye, the pupils will see with their own eyes the customs of a land, its products and resources. For studies such as botany and zoology the films will bring living specimens into the classroom. Who will say that an x-ray film showing the various bones of the human body in action will not leave a more lasting impression on the student's mind than a chart and words?

Films on historical subjects, which are being made for display in the regular theatres, are becoming truer in detail every year.

With the wealth of historical authorities among the Appleton staff of authors, is there any reason why the history of the world cannot be told in a film form absolutely faithful in all detail?

Universal-Appleton educational films will be made with the cooperation of the authors who write the Appleton Textbooks. David Starr Jordan, former Chancellor Emeritus of Leland Stanford University and one of the world's foremost authorities on zoology, will give his approval to the zoology pictures which are to be used with his famous textbooks. In order that school children of the future will not have to be content with merely reading how George Washington crossed the Delaware, Mrs. Gertrude Southworth will aid in making motion pictures of the famous trip across the river. Dr. John M. Coulter, of the University of Chicago, will cooperate in the production of botany films for his widely read books. Robert H. Brandbury, chemistry; F. R. Gorton, physics, and J. J. Klein, bookkeeping, are some of the other authorities whose names will give assurance that the films are pedagogically sound.

In anticipation of such a demand for its works, the Universal company has jealously guarded a number of educational subjects which, when they were photographed, were the talk of the educational world. Among these are a series of pictures on the Far East, taken during the memorable tours of Dr. Dorsey; the Findley Nature Study series; a series of pictures taken by Homer Croy in East India; and a series of pictures on animal life taken by Mr. Dirmars, one of the most noted authorities in the world on animal topics. Six expeditions now visiting foreign countries for the purpose of photographing physical and geographical conditions, are being supervised by Universal. One of the most important of these expeditions is being made under the auspices of the Smithsonian Institute.

Films in classrooms have been made possible by a new type of projection machine. With the new machine a fireproof booth is not necessary; the machine can be operated in a powder factory with perfect safety. The machine is so small that it can be packed in a suit-case, and is comparatively inexpensive. It requires no training to operate it. A pupil can be delegated to connect it with the nearest light socket, fix the reel in place, and press the button which starts the film.

THE FATIGUE OF METALS

By MELVIN R. CHARLSON,

Senior Civil.

That metals which are subjected to reversed stresses may fail at unit stresses below their elastic limit, was the statement made by H. F. Moore, Rerearch Professor of Materials at the University of Illinois, at a lecture given in the Auditorium of the Engineering Building on December 4. Professor Moore illustrated his lecture with a remarkable motion picture of a metal under repeated stresses which showed the development of the cracks which produce failure.

Experiments upon the fatigue of metals date back to 1840 or 1850, but microscopic experiments were not attempted until 1890. Early experimenters thought that material under reversed stresses crystallized and that this crystallization brought about failure. This theory was disproved when it was shown that nicked specimens, broken under impact, also revealed crystallization.

Renewed interest in the fatigue of metals was caused by the failure of railway car axles. Torpedo boat shafts, aeroplane shafts, and automobile axles are other machine parts that are subjected to reversed stresses. If the stress to which the part is subjected is far above the elastic limit the number of reversed stresses it can withstand may not be many. If however, the unit stresses are below the elastic limit, the part may be subjected to many millions of reversed stresses before failure occurs.

The specimen selected to illustrate failure by fatigue was a rod of iron. One end of the specimen was rigidly clamped and the other end securely fastened in the jaws of a machine that had a vertical vibrating motion. When the machine was set in motion about an inch of the specimen between the jaws of the machine and the stationary clamps was subjected to reversed stresses. The first indication of any change in the structure of the specimen was the appearance of first a single and then numerous very fine lines. These lines are symptous of failure. The individual crystals have been highly strained and are parting on their cleavage plans. These minute lines gradually broadened and some developed into cracks, which were still invisible without the aid of a microscope. The lines when first noticed are known as slip lines. One of the minute cracks developed until it ultimately caused failure of the specimen.

WHY MEMORIZING IS ESSENTIAL TO THINKING.

For about a generation most youths have been taught to look with something akin to contempt upon memorizing data. They have been told that the prime object of education is to train the reasoning powers and that this is not accomplished by parroting. Consequently it has become the commonest axiom among college-bred men that memorizing does not develop the capacity for thinking. Yet it takes no great amount of cogitation to establish the fallacy of such a generalization.

The processes of thinking, as anyone will admit, are entirely dependent upon the ability to remember at least some facts. Even the reasoner who relies upon indexes to guide him to the data that he uses in reasoning must first have a sufficiently good memory to know the meanings of the words that he seeks in the indexes. But if his reasoning is to be at all expeditious he must remember a great deal more than the bare meaning of each term that he thus uses. Consider what a handicap a structural engineer would labor under were he able to remember only the meaning of such terms as "factor of safety," "elastic limit," and the like, without remembering any numerical data applicable to the terms.

It is more than a coincidence that both the soundest of reasoners and the most prolific of inventors have great stocks of memorized facts at their instant command. Of course it is not ordinarily essential that their memorized data relate to many fields of knowledge. It usually suffices if they remember a great many facts in a somewhat narrow field—the field to which their daily work relates. By remembering many details in his special field, a reasoner is less likely either to generalize incorrectly himself or to be imposed upon by the false generalizations of other reasoners.

We cannot urge too strongly upon our readers the advisability of reading often and regularly with the express object of gathering a large store of facts. It will not suffice to rely upon indexes or even to wait till the moment of necessity before searching for applicable facts, for psychologists are unanimous in saying that the brain uses with maximum effectiveness only those data that have been slowly analyzed and brought into co-ordination with other data.

Engineering and Contracting.

SUCCESSFUL WISCONSIN ENGINEER

SIDNEY JAMES WILLIAMS, g '08, C. E. '15



Sidney J. Williams, secretary and chief engineer of the National Safety Council, was graduated from the course in general engineering in 1908, and in 1915 received the advance degree of Civil Engineer. From 1908 until 1913 he was superintendent and engineer for a general contracting company at Milwaukee. In 1913 he became connected with the Industrial Commission of Wisconsin as the result of a competitive civil service test. Mr. Williams had charge of the formulation of the State Building Code of Wisconsin and later, of the administra-

tion of this code, the first complete building code established by any state.

While with the Wisconsin Commission, Mr. Williams was largely instrumental in the formulation and revision of regulations on safety and sanitation in factories and other places of employment. He also supervised the field work of the Commission in respect to safety and sanitation. In 1917 he was appointed engineer to the Commission and is largely responsible for the new elevator code established at that time. During this period, he also helped organize and later, became secretary of the Building Officials Conference, a national organization. In April, 1918, he organized an Industrial Service Conference for Wisconsin Employers at which safety, sanitation, industrial hygiene, and other problems of employment management were taken up.

In June, 1918, Mr. Williams joined the staff of the National Safety Council in Chicago. The Council is a co-operative association of about 3,800 members, mostly employers of labor, who are interested in accident prevention as an aid to efficiency, and in other activities which help to promote the health, comfort, and happiness of their employees.

EDITORIALS

KEEP IT UP, FROSH!

According to the statistics compiled by the Assistant Dean, the present freshman class is maintaining a higher scholastic average than that of several previous classes. This bit of information comes in time to correct at least one false impression, namely the idea that an unusually high percentage of the yearlings are going to be "advised to withdraw" at the end of the semester or before the end of the year. Some of the new men who are really doing good work feel discouraged because of such reports. Dean Phillips stated recently that the standards of the school are not being raised in order to reduce the number of freshmen; the students will have the same chance as in other years. The freshmen who are devoting the proper amount of time and energy to their studies should, therefore, continue with confidence. The unusually high enrollment has brought about a fine spirit of competition in the classes, as evidenced by the higher general average; there would be no justice in any deliberate reduction of the number of students.

THE CLAIMS OF THE METRIC SYSTEM

A vigorous campaign is under way to have the United States formally adopt the metric system of weights and measures. Back of this campaign is the World Trade Club, which, we are told, is "an organization of 500 live-wire manufacturing merchants engaged in world commerce." Its headquarters are in San Francisco. The matter is one in which engineers have considerable interest and about which they should have an intelligent opinion. Attention is therefore directed to the article by Mr. Drewry which appears on another page in this issue. Mr. Drewry takes a partisan stand upon the question, but presents some facts of major importance that are not commonly known among all classes of engineers. The article is worthy of a few minutes of your time.

THE MOVIE AS A TEXT BOOK

The class in railway construction had reached the subject of tracklaying. The recitation opened with a bombardment of questions in regard to methods of operating tracklaying machines. Instead of the more or less vague generalities that the

questions usually elicited, the answers that were snapped back were cleancut and contained a wealth of detail that the students had never obtained from the text. It was certain that not all of the men before him could have had experience in tracklaying; so the instructor was puzzled. "How come?" he inquired, and then the class confessed that it had done its bucking the night before at the Orpheum, where there was a movie of a tracklaying machine in action. Instead of putting in a hour and a half in preparing a poor recitation, the class had prepared a first class recitation in four or five minutes.

Those who had the opportunity of learning infantry drill and the small arms manual via Uncle Sam's remarkable movie will readily indorse the statement that the screen is quicker than language when it comes to the matter of creating a mental image. By combining photographs of well trained squads in drill formations and diagrams of the same formation, the screen picture made clear the somewhat vague directions of the manual. Even the slowest witted man in the squad could learn his part in the squad movements and learn it quickly.

Inability to visualize is the stumbling block of most poor students. Mathematical operations are a mere juggling of numbers to such men; they fail to sense the thing that the mathematical operation represents. History is a mess of names and dates; they fail to realize that history concerns real people as human as themselves. Mechanics is a series of riddles which one must guess or be fed to the lions. The movie will make it possible for the slow man to grasp an idea quickly; it will also make it possible for the fast thinker to work even faster. In fact all students should benefit immensely from the introduction of the movie into the educational field.

The idea of visual instruction is not a new one,—our own Extension Division has a department devoted to that purpose. But, while the idea is not new, the undertaking of the Universal-Appleton combination to develop the educational possibilities of the film as described on another page, gives promise of marking a distinct advance along this line. Engineering subjects offer an excellent field for visual instruction and it is to be hoped that some energetic organization will see that this particular field is properly developed.

THE MONEY DEBT OF AN ALUMNUS

The young darkey and his dusky bride stood before the Justice. The knot had been tied, the ring sparkled upon a slender finger, and now only one more rite remained to be fulfilled. "Yuah Honoah," said the bridegroom, as he toyed with the rim of his his hat, "How much is I indebted to you foah?" "Just whatever it is worth to you, Sam," the Justice answered with a twinkle. Same looked down into the face of his loved one with a glance full of tenderness and then up at the Justice and said with a troubled voice. "Why boss, if I pays dat, I'll be bankrup' foah life." That is about the feeling a generous alumnus has for his alma mater. If he has been worthy of his training he realizes that his debt is one that can never be repaid,—at least in dollars and cents. It is interesting therefore to note an attempt that has been made to evaluate the money debt of an alumnus. The Cornell alumni have undertaken to raise \$5,000,000 and as a guide to the members have prepared the following table which is supposed to show "the present amount of the average excess cost of instruction over full tuition, compounded at 5 per cent, and based upon the purchasing power of the dollar in the respective academic years:"

If the student entered in:

1899 such amount is	\$3,523
1900 such amount is	3,258
1901 such amount is	3,079
1902 such amount is	2,878
1903 such amount is	2,694
1904 such amount is	2,491
1905 such amount is	2,321
1906 such amount is	2,158
1907 such amount is	2,012
1908 such amount is	1,918
1909 such amount is	1,785
1910 such amount is	1,667
1911 such amount is	1,579
1912 such amount is	1,479
1913 such amount is	1,343
1914 such amount is	1,140
1915 such amount is	931

UNIONIZING THE TECHNICAL MAN

It may be news to some of our readers that the union idea is gaining a strong foothold among technical engineers. There are said to be something over 8,000 draftsmen affiliated with the American Federation of Labor. This fact is not surprising, perhaps, in view of existing conditions. There are many draftsmen who are not technically trained men. A considerable proportion of them may be expected to stick to the drafting board and to constitute a class of skilled workmen on a plane with other skilled workmen. Their responsibilities are not great and their places are comparatively easy to fill. Nevertheless there is menace to technical engineers in the unionization of the draftsmen, first, because the drafting board often is the first stage in the practical training of the engineer and, if the young engineer must pass through a training period as a union man he is apt to lose something of that fine spirit of loyalty to his job that has distinguished the engineer up to the present time; second, because the small practicing engineer is apt to find his work interfered with by the union. Recently, in one of our western cities, the union draftsmen tried to reach an agreement with the building trade unions whereby the latter would refuse to work on any structure if the plans for the structure were not union made. Such a situation contains interesting possibilities.

Of greater importance than the unionization of draftsmen is the fact that many of the technical engineers employed by the government have joined the union. There are at least two Technical Sections, A. F. of L., in the east, and they contain among their members, men high in the ranks of governmental departments. These men are said to be convinced that the only way in which they could win recognition from the present government was by unionization. They feel that joining the union was the price of a decent wage. Apparently the attitude of the government is: "You get no salary increase unless you force me; you can't force me unless you are in a position to tie up business; the A. F. of L. is just around the corner." This attitude on the part of government officials is so peculiar that one is led to speculate as to possible motives. Are we watching the building of a powerful political machine, designed to keep present incumbents in power, and equipped with a Union motor? And is the Engineer to be one of the many nuts in the motor?

ALUMNI NOTES

By WILLARD A. KATES

1908

The Class of 1908 has just distributed among its members a volume of 129 pages containing the autobiographies of many of the live ones. We are going to take the liberty of borrowing from its pages for the benefit of our readers who are so unfortunate as not to belong to the Sure as Fate class but who are fortunate enough to know some of its members.

The men who conceived and carried out this project deserve the thanks of their classmates; for it is easy to see that much effort has been expended upon the book.

Engineers are strong in the class organization: E. F. Rice is President, Charles Byron is Class Historian, and Mrs. Charles Byron is Vice-President. On the Executive Committee we find the names of Charles Byron, Walter Lindemann, and Prof. Roy Shorey.

VICTOR R. ANDERSON, m '08, after a period of Army service is again with the Dominion Fireproofing Company, 32 Central Bldg., Calgary, Alta, Canada.

FRANK S. FROST, m '08, M. E. '12, is in the Research Department of Sears, Roebuck & Co. His home address is 528 S. Oak Park Ave., Oak Park, Ill.

WILLIAM W. MATTHEW:, c '08, is with Alvord & Burdick of Chicago.

JOHN H. THICKENS, ch '08, Ch. E. '12, is member of the Management Engineering & Development Company and General Manager of Kingsport Pulp Corp., Kingsport, Tenn.

WALTER EDWIN WAITE, e '08, is Examiner of Patents, U. S. Patent Office, Washington, D. C.

EDWARD R. WIGGINS, m '08, is Technical Editor of the Chilton Tractor Journal. His address is 1126—14th Ave., Moline, Ill.

W. H. CURWEN, c '11, gives his address as care U. S. B. P. R. & R. E., 301 Customs Bldg., Denver, Colo.

LOUIS S. DAVIS, c '10, is with the State Highway Commission of Montana. His address is 610, 13th Street, N., Great Falls, Mont. Davis was a captain of engineers in France, being divisional gas officer for the 1st and 92nd. Divisions. He was married at the close of the Second Officers' Training Camp, and he and Mrs. Davis, formerly of St. Joseph, Mo., are spending a belated honeymoon at Great Falls. He reports cold weather and has sent an S. O. S. to Ray Owen for a 3-point Hudson Bay blanket which the latter has been keeping for him. Odds that he doesn't get it so long as the zero weather hangs on in Madison.



HOWARD BUCK

Quinlan, consulting engineers of Chicago. He is in charge of the office at Dallas, Texas.

✓ ROY H. DAVIS, c '17, is in the employ of Alvord & Burdick, consulting engineers of Chicago.

✓ JOHN H. GRIFFITH, c '93, M. S. '98, until recently Associate Engineer-Physicist, U. S. Bureau of Standards, U. S. Arsenal, Pittsburgh, has been appointed to the civil engineering faculty at Iowa State College.

✓ WILLIAM S. JOHNSON, c '17, was married Nov. 26, to Alice Marie Denson of Waterloo, Iowa. Johnson is working with the City Engineer of Janesville.

W. R. McCANN, E. E. '15, on January 1, entered the employment of the Stone & Webster Corporation at 147 Milk St., Boston.

✓ G. C. McNAUGHTON, ch '09, is with the Kingsport Pulp Corp., Kingsport, Tenn.

✓ F. MEINECKE, min '12, has left the military service. His address is 623 Milwaukee Street, Milwaukee, Wis.

WILLIAM M. MULHOLLAND, former student in civil engineering, is resident engineer on construction of drainage ditches for the Little River Drainage District at Cape Girardeau, Mo.

✓ RAYMOND A. PHELPS, c '16, was married on December 3, to Hazel Dobson of Beloit. Phelps is sales engineer for the Davis-Hanson Co., of Oshkosh.

HOWARD "CUB" BUCK, c '17, the greatest tackle that Wisconsin ever put into football togs and for the past three years Athletic Director at Carleton College, has announced his intention of giving up coaching and taking up his engineering profession.

✓ FERDINAND D. BICKEL, C. E. '15, is assistant chief engineer for the Oliver Mining Company, at Eveleth, Minn.

✓ JOHN E. BROBST, e '03, is manager of the Control Department of the Westinghouse Electric Co. *at St. Louis*

✓ R. O. BUCHHOLZ, c '19, gives his address as 1417 Hartford Bldg., Chicago.

WILLIAM J. CAMLIN, c '18, former Business Manager of the WISCONSIN ENGINEER, was married on January 1, at All Soul's Memorial church, Washington, D. C., to Katherine Warren Browne, H. Ec. '18, daughter of Representative and Mrs. Edward Browne of Wisconsin.

✓ ARTHUR W. CONSOER, c '14, who spent two years in France and became Captain of Engineers, is southern manager for Older &

WALTER J. PARSONS, c '00, reports that the W. J. PARSONS HOUSING Co. has moved its office to 813 Hartford Building, Chicago.

MR. J. H. PLATT, instructor in machine design, was married on Dec. 31, at Dayton, Ohio, to Miss Florence Rogge.

J. W. REED, e '15, is sales engineer for the Holtzer Cabot Electric Co., 125 Amory St., Boston. He is living at 6 Clafin Road, Brookline, Mass.

H. J. SAUNDERS, c '03, may be reached at 24 Oakvale Ave., Berkeley, Calif.

CAPT. CHARDES M. SCUDDER, c '11, C. E. '12, former instructor in mechanics at this college, has returned from France and may be addressed at 1426 First Wisconsin National Bank Building, Milwaukee.

A. C. SLADKY, m '11, is assistant superintendent for the National Enam. & Stamp Co. His address is 525 Newton Ave., Shorewood, Milwaukee.

KEMPER SLIDELL, c '10, sales engineer for the Anglo American Mill Company, gives his address as 3732 Washington Street, Kansas City, Mo.

R. GILMAN SMITH, m '15, was a December visitor. He is Engineer and Statistician with the Milwaukee Electric Railway & Light Co.

JAMES A. STEWART, e '04, gives his address as 72 Nebraska St., Akron, Ohio.

W. H. STIEMKE, m '15, is secretary and treasurer of the Tractor Engineering Co. His address is 214 Stephenson Bldg., Milwaukee.

J. R. SWETTING, m '16, gives his address as 617 Smith Ave., Lansing, Mich.

WALTER S. TODD, c '15, on January 1, became Assistant Bridge Engineer with the State Highway Department at Springfield, Ill.

THOMAS UTEGAARD, c '17, is with the City Engineer of Janesville.

H. WARD, e '05, is manager of the Rochester office of the General Electric Co.

HENRY M. WARNER, c '04, died suddenly of heart failure at his home in Evanston, Ill., on Dec. 5. "Mike," as he was affectionately known by his classmates, was connected with the Mead-Morrison Mfg. of Chicago. He leaves a widow, formerly Lucy M. Fox of Madison, and a daughter, seven years old.

G. R. WELLS, e '15, who has been an instructor in the Extension Division, is located at 320 Broadway, New York.

JAMES G. WRAY, e '93, consulting and telephone engineer, has opened an office at 1217 First National Bank Building, Chicago. Mr. Wray has been doing considerable work for the Canadian government.

HENRY W. KURTZ, c '19, has left the Wisconsin Highway Commission, for which he designed bridges since last April, to take a position with the Prairie Pipe Line Co., in Oklahoma. At present he is installing oil pumping machinery. His new address is Exchange National Bank Building, Tulsa, Oklahoma.

CAMPUS NOTES

By WILSON D. TRUEBLOOD

Prom and Leap Year! Gosh fellows, isn't it too much for once?

Better a rented dress suit and the money for next semester's fees in the pocket than a made-to-order creation that sets you back an American ambassador's ransom and which will be too tight around the waist next winter.

Oh slush, Gertie! No wonder you dance heavy. You forgot to remove them galoshes.

If you are worried about those coming exams just borrow a pair of skis, climb to the top of that suicidal slide that the Norwegian boys built on Muir Knoll during the Christmas vacation, and take a leap off the end of the world. If you aren't killed, it's a sure sign your luck is good and you don't need to worry about a little thing like an exam.

Eyes beginning to hurt?

Directions for operating the first floor drinking fountain

- (a.) Place books on floor.
- (b.) Apply mouth firmly to orifice.
- (c.) Grasp rim of hat in left hand.
- (d.) Press button with right hand.
- (e.) Have janitor wipe brains off ceiling.

CAMPUS GOAT-GETTERS

The man who carries an umbrella when it snows.

The frosh who sings "Home Sweet Home."

Steam and Gas reports.

The fellow who always comes late to class.

The male who wears his galoshes open.

Sweet young thing—"Won't you buy a tag for the Epizootic Horsepital?"

The adviser who doesn't keep his office hours.

Waiting in line.

LEAP YEAR VICTIM NO. 1

Our editor, Chris Wiekking, has fallen before the charms of a home-ec—or was it her culinary proficiency? Chris, you know, is a gran' li'l eater.

Mr. Charles M. Kurtz has been called to the engineering faculty. Mr. Kurtz is at present in the engineering department of the Southern Pacific Railroad and is located in San Francisco.

The Mining Club has created the office of Publicity Manager and elected L. H. Hahn to fill it. At the same time, plans were made for compiling a year-book which will be a history of the Mining Department for the current year. Everett L. Grubb will be the editor. As a history it will probably read like the bill of fare at Cop's restaurant.

Conversation between law student and engineer in Morgan's:
Law—"Did you notice how slippery the sidewalk was from the Engineering Building to the street?"

Engineer—"Yes."

Law—"Those roughneck engineers think it is funny to slide down the sidewalk, and then watch the girls try to walk down."

Engineer—"Are you sure the engineers do it?"

Law—"I sure am. I saw a big stiff walk out of the Engineering Building this morning and start to slide down the hill. I remember him distinctly. He had on a flannel shirt, wore flapping galoshes, and—"

Engineer—"Stop right there. Wore flapping galoshes, did he? He wasn't an engineer."
F. H. H.

The American Association of Engineers has granted a charter for a chapter at Wisconsin. A number of faculty members and about fifty students sent in their applications for membership. L. H. HAHN, a junior in the mining course, is largely responsible for the establishment of this new chapter.

The shop professors are now using their hip pockets for the safe keeping of—the WISCONSIN ENGINEER, as three copies of the last issue mysteriously disappeared within an hour. They earnestly entreat the circulation manager to make clear the fact that the source of supply is in the Engineering Building and not in the shops.

The math shark was immersed in the Four Horsemen; the engineer was immersed in work. "Say, what's the square of 57?" asked the latter, at the same time reaching for his book of tables. The math shark didn't pause in his reading; he murmured, "3249," and went right on. "B'gosh, that's right," said the engineer, as his finger rested on 57 in the table of squares, "How'd you happen to know that one?" "I didn't know it; I figured it," answered the shark, still absorbed. "Don't hand me anything like that," the engineer remonstrated, "you did it too quick for that." The shark pricked up his ears; "I'll make you a little proposition," he said. "Here is two dollars and twenty cents—the twenty cents pays the war tax—that I will venture to hazard against an equal amount of your filthy lucre for the purpose of giving dignity and responsibility to my assertion that I can tell you the square of any number of two figures within ten seconds and without the aid of book, sliderule, or other extraneous device." "I hear you, but I don't know what you are saying," the engineer answered; "Here's my money. What's the square of 73?" The answer came promptly, "5329." Other numbers followed until the engineer gave up the attempt and his money and asked how it was done. "I don't mind telling you," the shark said, as he tucked his winnings away and picked up the Four Horsemen once more. "You know that $(a + b)$ times $(a - b)$ equals $(a^2 - b^2)$. Well, if you want to square 57 you first add 3 to 57 and get 60; then you subtract 3 from 57 and get 54. Then you multiply 60 and 54, mentally, and get 3240, which is $a^2 - b^2$. In this case b is 3, so we square 3 and add it to 3240, and get 3249 which equals a^2 ." The engineer rested his chin in his hand and did some figuring. At last he shook his head apparently satisfied that there was nothing phoney about the stunt. The math shark watched him narrowly while pretending to read. Soon he spoke in luring accents. "Now," he said, "I'll bet that you can't square a number of two figures, mentally, in ten seconds." "Nothing doing," replied the engineer, turning back to his work, "You've nicked me enough for one night; and, besides, I need practice at that stunt."

ARTHUR W. EDWARDS, who has withdrawn from the University, is with the U. S. Geological Survey at Marathon, Texas.

WHO'S TO BLAME?

The health and happiness of a whole machine-shop-full of frosh Engineers was outrageously jeopardized the other day when a large party of co-eds wandered through in the middle of the busy afternoon. The girls were there for a demonstration of forge work, a part of their course in manual arts. Someone ought to be court martialed for exposing the hard-worked wearers of the green button to such hazardous risks! Why, nobody even gave a moment's warning! One minute the greasy amateur machinist was busily milling on his gear-blank; the next he was gazing in rapture at the gorgeous spectacle before him, while he wound his necktie up in the driving pulley and choked himself,—or ran his fingers through the open driving gears. Brethren, such things ought not so to be! Taint fair! Why not at least stop the engine, or give a ten-minute recess, when so many fair ones invade the empire of the calipers?

H. D. T.

The Civil Engineers Society met Thursday evening, December 11. There were thirty members present and a number of visitors. OLAF ROVE spoke on, *How to Use the Engineering Library*, and C. L. RICH on, *Business Experiences*.

Three engineers, CAPT. KNAPP, BARLOW, and SCHNEIDER, are playing with the varsity basket ball squad. Knapp and Barlow have played first string before, but this is Schneider's first year. In playing off the tie with Ripon on December 13, Schneider made a field goal that brought home the bacon.

A third edition (20,000 copies) of the *Principles of Reinforced Concrete Construction*, by Turneure and Maurer, has been published. "All of the chapters relating to theory and general design have been thoroughly revised and rearranged, making them more satisfactory for use in the classroom. Material from actual designs relating to experimental results has been brought to date, while the theory underlying the various forms of flat slabs has been treated in a separate chapter."

The consulting firm of Mead and Seastone moved its offices on the first of the year to the third floor of the State Journal building.

THE FUSSING BUREAU

Well, boys pull the old silk derby off the chandeliers, grab the price of a bouquet of carnations, and prance! Your time has come, for, complying with the request made in the Cardinal of December 16, and responding to the wishes of hundreds of fur-coated, galoshed damsels we have inaugurated a genuine, up-to-date fussing bureau. No more nights at home, no more envious glances at professional heart-breakers—life will now be one sweet c to c dance right after another.

FOR THE INFORMATION OF APPLICANTS:

Girls, if you want a date with an (y) engineer, follow the directions here given:

Mail the following information to Matrimonial Editor, The Wisconsin Engineer, Engineering Bldg.

- (1) The name of the engineer with whom the date is desired.
- (2) If the name is not known please submit a description and the qualifications of the man wanted.
- (3) All requests must be in ink, signed with the writer's full name, and sealed. No post cards accepted. All letters will be confidential.

As a proof of the cyclonic effect the new movement is having on the campus, we wish to quote the following:

"Ever since I went to Prom with Kenneth last year, I have felt the need of a change. Get me a date while leap year moon is still shining.

Irene H.

"A perfectly dear arrangement! I can hardly wait to get my first proposal."

Tomme W.

Engineers desirous of early dates are named below, in the order of their application. Take your choice—a handsome lot.

- | | |
|--------------------|-------------------|
| 1. Howard Coomber. | 5. Foster Strong. |
| 2. Al Gerhardt. | 6. Rand Stegeman. |
| 3. Don Slaker. | 7. Ross Rogers. |
| 4. Al Krotz. | 8. Milton Powers. |

Etc.

To the Editor:

Have you noticed how many Commerce and Law men are wearing corduroys since a co-ed stated, in a communication to the CARDINAL, that the engineer makes an ideal husband?

W. J. R.

Editor's Note: The Fussing Bureau will protect it's co-ed clients from the advances of such culprits.

PROFESSOR J. B. KOMMERS has been granted a leave of absence to take effect at the end of the present semester. He goes to the University of Illinois to collaborate with Professor H. F. Moore on a comprehensive research of fatigue phenomena of metals for which Professor Moore has been given a grant of \$30,000 by the Engineering Foundation of the National Research Council.



EXHIBIT A

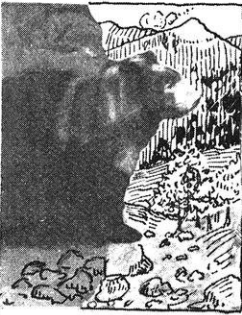

EXHIBIT B



EXHIBIT C

FAVORITE STORIES—PROF. CORP'S

Once upon a time, when I was prospector in the Far West, I and my faithful burro Friction were plodding over mountain trails toward the close of a summer day when, upon rounding a projecting ridge of a hillside, we came face to face with a wild bear. S'help me, 'twas awful. The burro was behind me, the hill was on one side, a chasm was on the other, and there in front of me that bear rose to his hind legs and licked his chops. I had no wings; flight was impossible; and so the bear soon had me in his mighty hug. Just when all seemed over for me the bear gave a shudder and dropped dead at my feet. What do you 'spose? The nail I was using to hold up my pants had pierced his heart and killed him instantly. You doubt the tale? Then, may it please the Court, I offer in evidence, Exhibits A, B, and C. Exhibit A shows me as said prospector. The one in the background is me. Exhibit B is said bear just before he pounced upon me. And Exhibit C is said nail. What more do you want?

PROF. L. S. SMITH of the engineering faculty addressed the Madison section of the American Institute of Electrical Engineers on Tuesday evening, Dec. 16, at 7:45 o'clock, in the assembly chamber of the Capitol. His lecture, which was illustrated, dealt with city planning and zoning.

Activity in the shops was at a standstill most of December on account of the holidays, but by boarding up and heating the tool room and installing a small 10-H. P. motor to drive part of the line-shaft, it was possible to carry on some important experiments in the development of a bearing metal that will not cut the shaft when running hot.

A student chapter of the American Institute of Electrical Engineers was organized on December 11, with a charter membership of about fifty. R. R. KNOERR was elected Chairman and H. R. HUNTLEY was made secretary-treasurer. The Executive Committee consists of PROF. BENNETT, CHASE DONALDSON, and D. R. LAMONT.

On Dec. 11, PROF. MAX MASON of the physics department gave an illustrated talk at main hall on the development and improvement of the submarine detector. Prof. Mason illustrated his lecture with slides showing the working parts of his invention and the various stages of its development. The detector consists of a series of small receivers which are placed along the side of the ship and which transmit the sounds to a central receiver, manned by one operator. At present the detector will reveal the presence of a submarine within 6,500 yards.

The price of tickets for the Junior prom has been set at \$7.70 for regular admissions and \$1.10 for spectators. Better write dad at once for that extra allotment for the month of February "due to the increased cost of meal tickets."

A contract to supervise construction of a half million dollar waterworks at Rockford, Ill., has been signed by the firm of Mead & Seastone.

Professor Arthur H. Blanchard, University of Michigan, is to deliver a lecture on asphaltic concrete and asphaltic macadam before the class in Roads and Pavements, about the middle of January.

HALF A SECOND OF YOUR TIME

We want you to know these drug stores.

THE MENGES PHARMACIES

26 West Mifflin Street
901 University Avenue
1825 Monroe Street
801 Oakland Avenue

U. R. NEXT

We have enlarged our shop to give you better service.

RUNKEL BARBER SHOP

616 STATE STREET

OTTO HARLOFF

KARL LOPRICH

HARLOFF-LOPRICH ELECTRICAL CO.

CONTRACTING and ELECTRICAL SUPPLIES

"TWO STORES"—

Cor. State & Frances Sts.—Phone Badger 1906.
210 Atwood Avenue—Phone Badger 1302.

SOME COOK.

When the cement works located in Quincy I hired out as cook.

The kitchen range was 829 feet wide, 1,354 feet long, and it took eighteen firemen to keep it hot. We had 519 cooks and 700 kitchen police. We mashed potatoes with a pile-driver and ground coffee with a 350-horse power "Liberty Motor." They hauled out the dirty pans on railroad cars, and the kitchen police went on roller skates. As I was also mess sergeant, I rode up and down the kitchen shouting orders through a megaphone.

We mixed flapjack batter with twelve concrete mixers, and had a steam shovel moving egg shells away from the door. Six kitchen police, with bacon rinds strapped to their feet, skating over the griddle to keep it greased.

SCHNEIDER'S STUDIO

ARTISTIC PHOTOGRAPHY

20 East Mifflin Street.

Kindly mention The Wisconsin Engineer when you write.

The IRVING

417 STERLING COURT

"NEAREST THE CAMPUS"

You Will Be Pleased
with the
SERVICE, QUALITY, AND PRICES

Cafeteria Style

Home Cooking

DON'T GO FUSSING—

unless you have a SINGER HAIR CUT

Singer's Barber Shop

Appointment by call or phone Badger 4987.

PRINTING

ENGRAVING

326 W. Gorham

THE PRINT SHOP

MADISON, WIS.

Badger 3691

Programs

CHAPTER PUBLICATIONS

Cards



644 State Street

A Place of Quality where Good Fellows
Get Together

LUNCH, HOT COFFEE
MALTED MILK
GOOD SMOKES
BILLIARDS

Tickets! Tickets!! Tickets!!!\$6.00 for \$5.00 **BUY NOW** \$6.00 for \$5.00**Pantorium Company**

(Quality Cleaners)

538 State St.

Phones 1180--1598

Vega Banjos and Gibson Mandolins at HOOK-BROS.

Bunde & Upmeyer Co.
Jewelers - Milwaukee

Where Quality Is As Represented

Grand Ave. and West Water St.—Plankinton Arcade Bldg.

**THE COLLEGE REFECTORY
AND ANNEX**

672-674 State Street

In order that we may serve the very best of food, we buy only high grade material and engage competent cooks to prepare it for you.

Our aim is QUALITY and not Quantity.

Variety	Courteous Attention	Clean Dishes
Rapid Service	Good Food	Home Cooking

Branch Bank of Wisconsin

State and Gilman Streets

Capital and Surplus \$360,000.00

Student Banking Headquarters

B. R. L'Hommedieu, Ass't Cashier

If you want to cut the
High Cost of Eating

— GO TO —

The Wayside Inn Cafeteria

240 WEST GILMAN STREET

Japanese Cooking
that beats mother's best

Plenty of Room For All !

All Engineers use fine stationery and party favors at times. We have
them. Come and see us.

THE NETHERWOOD PRINTING CO.
24 NORTH CARROLL STREET

SPECIFY—

WALK-OVER SHOES

YOU'LL APPRECIATE THE DIFFERENCE

JAY F. ROSE,

:-:

:-:

15 West Main Street

THE FIRST NATIONAL BANK

OF MADISON, WISCONSIN

UNITED STATES DEPOSITORY

Capital, Surplus and Undivided Profits, \$450,000.00

Transacts a general banking business. Issues letters of credit and travelers
checks good in all parts of the world.

GET THE LATE RECORDS AT HOOK BROS.

Tiedeman's Pharmacy

Get your prescriptions filled here—our drugs are first class.

Don't forget our sundaes and malted milks.

Tel.: B. 3763 and B. 4858.

Cor. University Ave. and Lake St.

Kennedy Dairy Company

VELVET ICE CREAM

"It's All Cream"

Let us fill your order for that party and the Sunday dinner

618 University Avenue

Phone: Badger 7100

SAY, YOU FELLOWS—

Let's all go over and have a Malted Milk at

FRED. MAUTZ'S

**FIRST CLASS SMOKES AND
BILLIARD TABLES**

Phone Badger 3160

823 University Ave.

Blued Printing Company
114 East Washington Ave.
Madison, Wisconsin

Kindly mention The Wisconsin Engineer when you write.

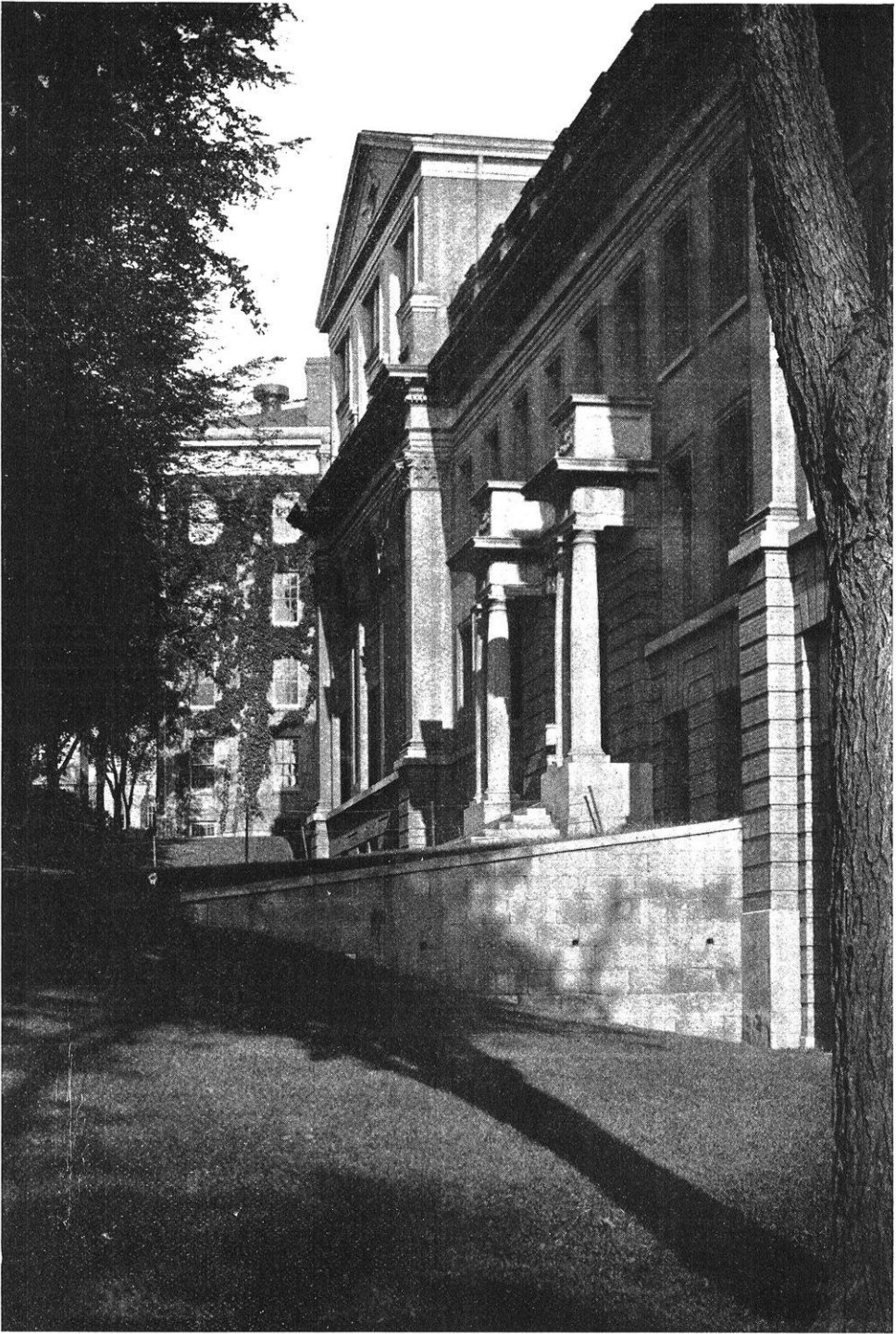

ENGINEERING BUILDING.

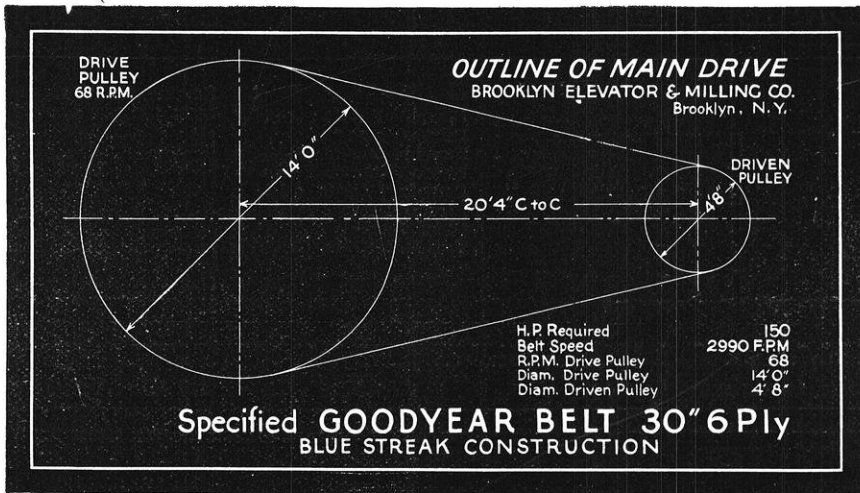

Belting Costs—and the G. T. M.

Cost of production equals in the consideration of factory manager and engineer the importance of improvement in the product and of increase in the output. Whenever a machine, a method or a facility can demonstrate more and better results at less operating cost, it commands their immediate interest.

Scientific analysis of existing plant conditions is the first step to increased efficiency and lowered cost, and that's the way by which The Brooklyn Elevator & Milling Company proceeded to improve the main drive in its plant and cut its belting costs.

They had the G. T. M., Goodyear Technical Man, devote expert study to that drive. He found they were using on it a belt that cost \$6.84 a foot and usually lasted about 18 months. His analysis was the direct means of retiring an idler on the drive and of saving the company at least \$389.28 in belting costs in 24 months.

The G. T. M. specified a 30-inch, 6-ply Goodyear Blue Streak. It cost \$229.60 less than its short-lived predecessor in the first place—though Goodyear Belts usually depend on long-continued service advantages to demonstrate their genuine economy. In more than two years of work now it has cost less than \$10.38 a month—as against \$26.60 per month for the belt displaced—and has occasioned neither trouble nor repairs, as against plenty of both on the ordinary belt.

The relation of belting to plant efficiency is treated in detail in the Goodyear Mechanical Goods Encyclopedia. This work emphasizes that a belt is really a machine part, and that the highest grade of belt service and the largest freedom from belt troubles is assured first by the specification of the proper type and construction of belt to the duty it is required to perform—the principle of the G. T. M. analysis plan. Students and teachers of engineering are invited to write for a copy to the Mechanical Goods Department, The Goodyear Tire & Rubber Company, Akron, O.

BELTING · PACKING HOSE · VALVES
GOODYEAR

Kindly mention The Wisconsin Engineer when you write.

DANIEL W. MEAD Consulting Engineers C. V. SEASTONE
Madison, Wis.



HIGGINS'

Drawing Inks
Eternal Writing Ink
Engrossing Ink
Taurine Musilage
Photo Moulder Paste
Drawing Board Paste
Liquid Paste
Office Paste
Vegetable Glue, Etc.

Emancipate yourself from the use of corrosive and ill smelling inks and adhesives and adopt the Higgins' Inks and Adhesives. They will be a revelation to you. They are so sweet, clean, well put up and withal so efficient. For home, office or school use they are positively the best.

Are the Finest and Best Goods of Their Kind

At Dealers Generally

CHAS. M. HIGGINS & CO., Manufacturers

Branches, Chicago, London

271 Ninth Street, BROOKLYN, N. Y.

ROEBLING WIRE ROPE

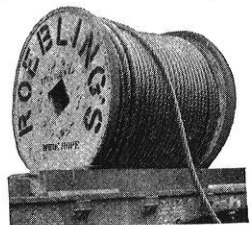
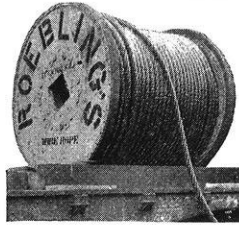
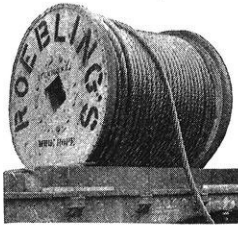

JOHN A. ROEBLING'S SONS CO.

TRENTON, N. J.

SAMSON SPOT SASH CORD



SAMSON CORDAGE WORKS, BOSTON, MASS.



Alundum

Crystolon

GRINDING WHEELS

For Steel and Steel Alloys

For all Grinding Requirements

For Cast Iron Brass, Bronze

NORTON COMPANY

NEW YORK STORE
151 Chambers St.

WORCESTER, MASS.

CHICAGO STORE
11 N. Jefferson St.

Kindly mention The Wisconsin Engineer when you write.

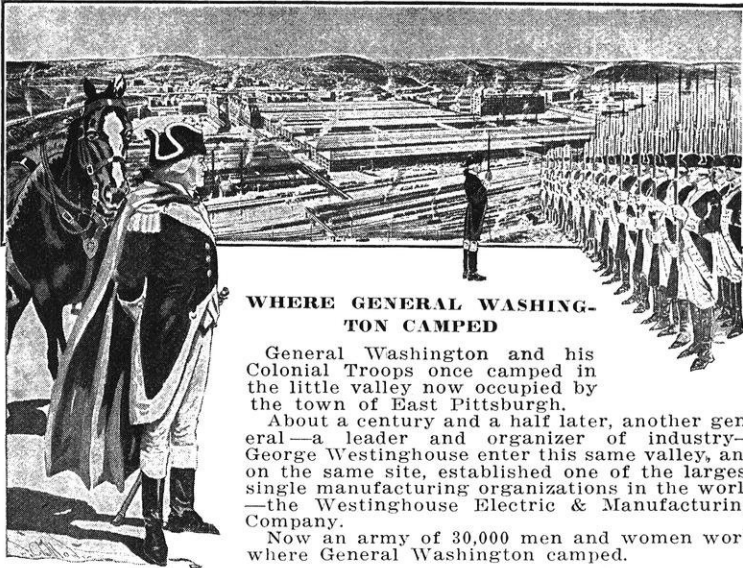

WHERE GENERAL WASHINGTON CAMPED

General Washington and his Colonial Troops once camped in the little valley now occupied by the town of East Pittsburgh.

About a century and a half later, another general—a leader and organizer of industry—George Westinghouse enter this same valley, and on the same site, established one of the largest single manufacturing organizations in the world—the Westinghouse Electric & Manufacturing Company.

Now an army of 30,000 men and women work where General Washington camped.

A Development Which Revolutionized Power House Practice

It was in this historic valley that the first commercially successful turbine-driven Alternating-Current Generator was developed under the direction of George Westinghouse. It was tested in the East Pittsburgh Shops in 1896. The splendid operation of this, and two duplicate machines installed a year later, sounded the death knell of the reciprocating steam engine—then in almost universal use.

The steam turbine has effected remarkable savings—one of the most evident of which is floor space—the turbine-generator occupying from one-fourth to one-sixth the space occupied by the reciprocating engine. In our large cities, with floor space valued at thousands of dollars a square foot, this is a consideration of great importance.

Ever since its organization, the Westinghouse Electric & Manufacturing Company has been foremost in the development of steam and electrical apparatus.

Westinghouse Electric & Manufacturing Co.
East Pittsburgh, Pa.

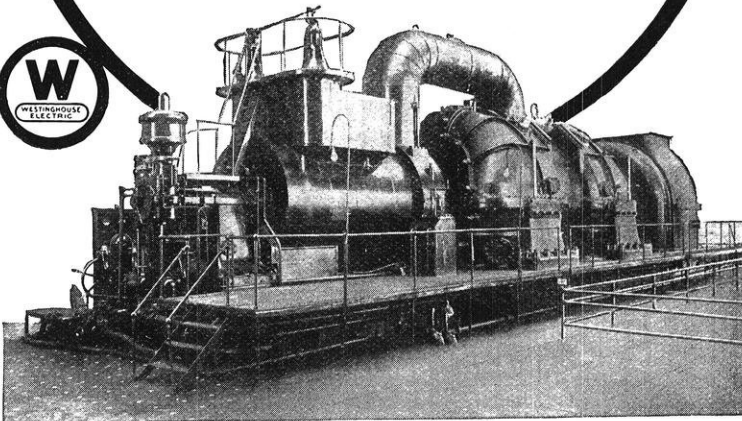

Superior Engineering Practices and Highest Manufacturing Standards



ALLIS-CHALMERS Products have won an enviable reputation throughout the engineering profession for highest efficiency and dependable service under hardest operating conditions, because these machines are designed according to the latest and best engineering practices and built according to highest manufacturing standards

Write for our Literature

*Sales Offices in All Principal
Cities*

Our Name Is Your Assurance

ALLIS-CHALMERS

Manufacturing Company

Milwaukee, Wis., U. S. A.

District Offices in All Leading Cities.

Kindly mention The Wisconsin Engineer when you write.

THE VILTER MFG. CO., 906 Clinton Street

Milwaukee, Wis.

Established 1867

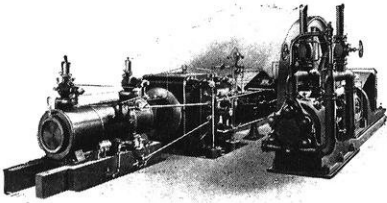

Builders of

Poppet Valve and Corliss Engines

Ice Making and Refrigerating
Machinery

The Pawling & Harnischfeger Co.

Milwaukee, Wisconsin

Offers to Engineering Students of the U. of W., bulletins and catalogs,
mailed free, on any of the following subjects:

**Electric Traveling Cranes, Drilling and Boring Machines,
Grab-Buckets, Hoists and Monorail Systems, and
Excavating Machinery.**

KISS THE PUP.

Prosecuting Attorney—Your Honor, the sheriff's bull pup
has gone and chawed up the court Bible.

Judge—Well, make the witness kiss the bull pup, then. We
can't adjourn court just to hunt up a new Bible.

LUFKIN ↔ ACCURACY



On Sale
Everywhere

Words instantly associated
in the minds of those who
measure, everywhere.



Send for
Catalogue

THE LUFKIN RULE CO.

SAGINAW, MICH.
New York, N. Y.

Kindly mention The Wisconsin Engineer when you write.

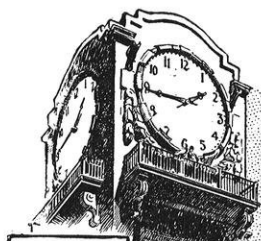

Tower clock wound automatically by one-half horse power motor.

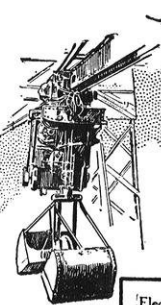

Electric monorail crane for hoisting coal.

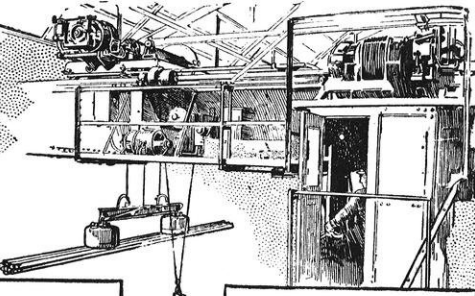

Motor-generator set mounted on crane supplying power for lifting magnet.

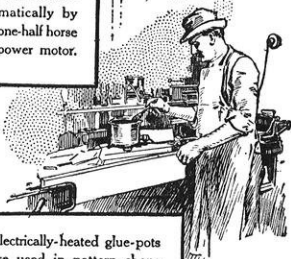

Electrically-heated glue-pots are used in pattern shops and elsewhere.

Electricity— the Master Force in Manufacturing

THE marvels of electricity have revolutionized our manufacturing industries. With belts and pulleys replaced by electric motors operating automatic—almost human—machines, many a slow and tedious process has been eliminated.

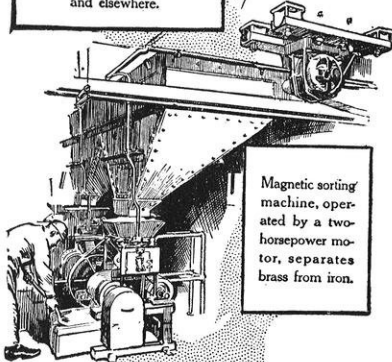

Magnetic sorting machine, operated by a two-horsepower motor, separates brass from iron.

The Crane Company's plant at Chicago—electrical throughout—is a model of industrial efficiency. Its 10,000 horse-power of driving energy is brought by three small wires from a distant power plant. Then electricity drives the machinery which handles the coal for heating, cuts the steel, sifts the sand and sorts the material—in fact does everything from scrubbing the floor to winding the clock.

Such an institution is marvelous—superhuman—made thus by the man-multiplying force of electricity. The General Electric Company has been instrumental in effecting this evolution by developing efficient electric generating and transmission apparatus and by assisting in the application of electrical energy to a multitude of needs.

General Electric Company

General Office Schenectady, N.Y. Sales Offices in all large cities.

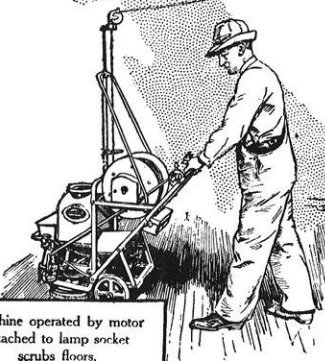

Machine operated by motor attached to lamp socket scrubs floors.

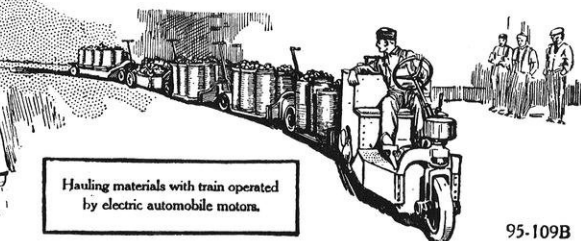

Hauling materials with train operated by electric automobile motors.

95-109B

Kindly mention The Wisconsin Engineer when you write.