

**PHOSPHOROUS AND ARSENIC SENSORS FOR REAL
TIME ENVIRONMENTAL MONITORING**

**Daniel Noguera
Marc Anderson
Isabel Tejedor
Jesse Wouters**

2017

**PHOSPHOROUS AND ARSENIC SENSORS FOR REAL TIME ENVIRONMENTAL
MONITORING**

Daniel Noguera
Department of Civil and Environmental Engineering
University of Wisconsin-Madison

Marc Anderson
Department of Environmental Chemistry and Technology Program
University of Wisconsin-Madison

Isabel Tejedor
Department of Environmental Chemistry and Technology Program
University of Wisconsin-Madison

Jesse Wouters
Department of Civil and Environmental Engineering
University of Wisconsin-Madison

Administered by:
University of Wisconsin Water Resources Institute

Funded by:
State of Wisconsin Groundwater Research and Monitoring Program

2017

This project was also supported, in part, by General Purpose Revenue funds of the State of Wisconsin to the University of Wisconsin System for the performance of research on groundwater quality and quantity. Selection of projects was conducted on a competitive basis through a joint solicitation from the University and the Wisconsin Departments of Natural Resources; Agriculture, Trade and Consumer Protection; Commerce; and advice of the Wisconsin Groundwater Research Advisory Council and with the concurrence of the Wisconsin Groundwater Coordinating Council.

Phosphorous and Arsenic Sensors for Real Time Environmental Monitoring

Project Number: WR15R001

PI: Daniel Noguera, Professor, Department of Civil and Environmental Engineering, University of Wisconsin-Madison

Co-PI: Marc Anderson, Professor, Environmental Chemistry and Technology Program, University of Wisconsin-Madison

Isabel Tejedor, Senior Scientist, Environmental Chemistry and Technology Program, University of Wisconsin-Madison

Jesse Wouters, Postdoctoral Research Associate, Department of Civil and Environmental Engineering, University of Wisconsin-Madison

August 2017

TABLE OF CONTENTS

PROJECT SUMMARY	3
INTRODUCTION	5
PROCEDURE AND METHODS.....	6
RESULTS AND DISCUSSION.....	7
CONCLUSIONS AND RECOMMENDATIONS	13
REFERENCES	14
APPENDIX.....	15

LIST OF FIGURES AND TABLES

FIGURE 1. – Setup used to perform the EIS testing (not to scale).	6
FIGURE 2. – Phase angle vs. frequency curves in a 0.01M NaClO ₄ solution (pH=7); A. 1.0 mm titanium support sputter coated with platinum; B. 1.0 mm titanium support sputter coated with platinum and dipped 10x in the ZrO ₂ sol (heated at 400°C between coatings).....	9
FIGURE 3. – Arsenic calibration curve at a frequency of 177.78Hz for a 1.0 mm titanium support sputter coated with platinum and dipped 10x in a ZrO ₂ sol (heated at 400°C between coatings); same electrode as that shown in Figure 2.	10
FIGURE 4. – Calibration curves for different solutions spiked with arsenate at a frequency of 355 Hz; A. 0.01M NaClO ₄ ; B. 0.01M KClO ₄ ; all solutions pH=7.	10
FIGURE 5. – Calibration curves for different solutions spiked with arsenate at a frequency of 355Hz; A. 0.005M Ca(ClO ₄) ₂ →0.01M NaClO ₄ →Ion Exchange solution; B. 0.005M Mg(ClO ₄) ₂ →0.01M NaClO ₄ →Ion Exchange solution; the arrows represent the test order; all at pH=7..	11
FIGURE 6. – Calibration curves for different solutions spiked with arsenate at a frequency of 355Hz; A. 0.01M NaNO ₃ ; B. 0.01M NaCl; in 5B two new electrodes were tested; pH=7.....	12
FIGURE 7 – Calibration curves for different solutions spiked with arsenate at a frequency of 355Hz; A. 0.005M Na ₂ SO ₄ (pH=7); B. 0.005M Na ₂ CO ₃ solution brought to a pH=7 (Test 1) and pH=5 (Test 2).....	13

PROJECT SUMMARY

Title: Phosphorous and Arsenic Sensors for Real Time Environmental Monitoring

Project I.D.: WR15R001

Investigators:

- Principal Investigator, Daniel Noguera, Professor, Department of Civil and Environmental Engineering, University of Wisconsin-Madison
- Co-Principal Investigator, Marc Anderson, Professor, Environmental Chemistry and Technology, University of Wisconsin-Madison
- Co-Investigator, Isabel Tejedor, Environmental Chemistry and Technology, University of Wisconsin-Madison
- Postdoctoral Researcher, Jesse Wouters, Department of Civil and Environmental Engineering, University of Wisconsin-Madison

Period of Contract: June 2015 - June 2017

Background/Need: Arsenic is a well known pollutant and of high concern in many areas of Wisconsin. The EPA limit for arsenic in drinking water is 10ug/L or 10ppb; while instruments such as ICP-MS or GFAAS are able to accurately detect arsenic concentrations in this range they are impractical for field measurements. Thus, a need exists for a technology/technique that can accurately detect low concentrations of arsenic in the field.

Objectives: To develop a field-deployable arsenic sensor utilizing electrochemical impedance spectroscopy (EIS) and metal oxide thin-film coatings.

Methods: (Year 1 and beginning of Year 2, WSEL - UW–Madison)

Composite sensor electrodes were fabricated by dip-coating a titanium sheet into different metal oxide sols (SiO_2 , ZrO_2 , TiO_2 , Fe_2O_3 , AlOOH). The composite electrodes were then submitted to EIS testing in a 0.01M NaClO_4 solution with varying concentrations of arsenate. The resulting impedance data was then used to develop arsenic calibration curves. In addition to the different metal oxide coatings, the influence of the following factors on the arsenic calibration curves were also studied: 1) Heating temp. between coatings; 2) Quantity of metal oxide deposited; 3) Sputtering the titanium support with platinum. The metal oxide coating (and parameters) that produced the best performing sensor electrode (i.e. - greatest sensitivity/response to changes in the concentration of arsenic, sensitivity at high frequencies, reproducibility during the fabrication process) were used to produce new electrodes that were studied in the next phase of testing.

(Year 2, WSEL - UW–Madison)

In this phase of exploration, the best performing electrodes were tested in solutions with different ions present to inspect for ion interference with arsenic detection.

Results and Discussion: The results of the electrochemical impedance spectroscopy testing in a 0.01M NaClO_4 solution spiked with different concentrations of arsenate showed that the different metal oxide coatings produced different impedance curves and therefore different calibration curves for arsenic. In addition, the heating temperature between coatings, the quantity

of metal oxide deposited, and whether the support was sputter coated with platinum also appeared to influence the impedance curves. Of the sensor materials tested, the titanium support sputtered with platinum and coated 10x with ZrO₂ (heated at 400°C between coatings) appeared to be one of the most promising sensor materials for arsenic detection. It had good sensitivity to arsenic at high frequencies, the electrode fabrication was repeatable and it had good reproducibility during testing.

The ZrO₂ coated electrode was then tested with different ions present in solution to observe any interference with arsenic detection. When tested in 0.01M NaClO₄ or KClO₄ solutions spiked with arsenate (at pH=7), the arsenic calibration curves were very similar and had good sensitivity. When tested in 0.005M Ca(ClO₄)₂ or Mg(ClO₄)₂ solutions at pH=7, the calibration curves were less sensitive to arsenic; however, when the calcium or magnesium solutions were passed through a water softening resin filter cartridge the arsenic detection improved. When the sensor was tested in different 0.01M monovalent anion solutions: NaClO₄, NaNO₃ or NaCl the sensor performed well in the presence of ClO₄⁻ and NO₃⁻, but not as well with Cl⁻. Likewise, when anions such as: SO₄²⁻ or carbonate species were present (Na⁺ as the cation), the sensitivity for arsenic detection decreased compared to that of the NaClO₄ or NaNO₃ systems.

Conclusions/Implications/Recommendations:

- The use of different metal oxides to coat the support appeared to influence the EIS curves and thus the calibration curves for arsenic (V).
- The ZrO₂ coated electrode appeared to be one of the best candidates for an EIS arsenic sensor material.
- When the ZrO₂ coated electrode was submitted to solutions with different cations present (ClO₄⁻ as the anion) the sensor had good sensitivity to different arsenic concentrations in the presence of monovalent cations (Na⁺ or K⁺), while divalent cation (Mg²⁺ or Ca²⁺) solutions had improved sensitivity to arsenic after being passed through a water softening resin (compared to calcium or magnesium solutions that had not been passed through the water softening resin).
- When the ZrO₂ coated electrode was submitted to solutions with different anions present (Na⁺ as the cation) the sensor had good sensitivity to arsenic in the presence of NO₃⁻ and ClO₄⁻, but Cl⁻, SO₄²⁻ and carbonate species had decreased sensitivity and need to be examined in greater detail in future work.

Related Publications: None at this moment; however, we are currently in the process of preparing manuscripts and will notify the University of Wisconsin Water Resource Institute of future publications resulting from this project.

Key Words: arsenic, metal oxides, thin-films, sensors, electrochemical impedance spectroscopy

Funding: University of Wisconsin Water Resource Institute (WR15R001).

INTRODUCTION

Arsenic is a toxic pollutant that is found throughout the World. Regions in Wisconsin where the arsenic concentrations exceed that of the EPA limit of 10 $\mu\text{g/L}$ or 10 ppb are found throughout the state. Its most common oxidation states are either +3 or +5; particularly, in oxygenated areas with high redox potentials arsenate (As V) dominates and in reduced environments with low redox potentials the arsenite (As III) species is more prevalent.

A variety of analytical techniques such as inductive coupled plasma mass spectrometry and graphite furnace atomic absorption spectroscopy can be used to accurately detect low concentrations of arsenic. However, these instruments are expensive and large, making them impractical for conducting field measurements. Thus, there is a demand for a technology that can accurately detect arsenic concentrations (ppb range) in the field. To accomplish this task, many researchers have turned to electrochemical methods.

One of the most promising electrochemical techniques for detecting arsenic is using anodic stripping voltammetry (ASV) because of its low detection limits. However, a large portion of the literature dedicated to using the ASV technique for arsenic detection has been concentrated on the As (III) species (when AS (V) is examined it is often reduced chemically, rather than electrochemically, to As (III)). The research described in this report is focused on the detection of As (V) (arsenate) in water, and instead of using anodic stripping voltammetry we employ electrochemical impedance spectroscopy (EIS).

Electrochemical impedance spectroscopy is a powerful technique that is often used in the ultra-capacitor and battery industries. However, limited research has been devoted to its use in the development of groundwater sensors; particularly, those used for arsenic detection. In this paper metal oxides with different properties (i.e. – specific surface areas, porosities, zeta potentials) will be coated onto a conductive metal support (either titanium or titanium sputtered with platinum). The metal oxide coatings tested include: SiO_2 , ZrO_2 , TiO_2 , Al_2O_3 and Fe_2O_3 . Because each of the metal oxides has different properties associated with it each will likely react differently to arsenic in solution. Moreover, this should produce different impedance curves when arsenic is present and lead to different responses when the concentration of arsenic is varied. With this in mind the goal of this project is to develop a field deployable arsenic sensor. In order to accomplish this task the following three areas must be explored.

1. Determine which coating produces the greatest response to changes in arsenic concentrations.
2. Determine how the coating parameters (number of times dipped, heating temperature between coatings) and the support used (titanium vs. titanium sputtered with platinum) influence the electrode's ability to detect changes in arsenic concentrations.
3. Select the metal oxide coating (and parameters used to produce the coating) that have the greatest sensitivity to arsenic and evaluate the electrode's performance in the presence of ions that could potentially interfere with arsenic detection.

PROCEDURES AND METHODS

Electrode Fabrication

To fabricate the sensor electrodes two different supports were used. The first was a grade 2 titanium sheet (either 0.5mm or 1.0mm thick and purchased from GalliumSource, LLC) that was cut to dimensions of 1cm x 6cm. This support was sanded with: 100 grit (2 min. each side), 400 grit (1 min. each side) and 600 grit (1 min. each side) sandpaper prior to being coated. The second support utilized the same sanded and cut titanium, but was sputtered coated with platinum using a Denton Vacuum Desk II sputter coater (current = 40mA for 3min on each side of the titanium) to prevent the passivation of the titanium. Before being coated, the supports were heated to improve their wettability, with the non-sputtered titanium being heated at 250°C for 2 hours and the titanium sputter coated with platinum at a temperature of 400°C for 10 hours.

The heated supports were then dipped approximately 45mm into sols (nano-particle suspensions) of either acidic SiO₂, basic SiO₂, ZrO₂, TiO₂, AlOOH or Fe₂O₃ and withdrawn at a rate of 3.2mm/sec. Procedures used to produce the sols were obtained from the Anderson lab at the University of Wisconsin-Madison; similar recipes can be found in the literature: acidic and basic SiO₂ (Chu et al, 1997); ZrO₂ and TiO₂ (Xu and Anderson, 1991), AlOOH (Wouters et al, 2012 – without the reflux step), Fe₂O₃ (Moss et al, 2013). In order to increase the amount of metal oxide deposited on the supports, the number of times the material was dipped into the sols was increased and the temperature between the dips varied (heating time between dips = 30 min). After the coating process was completed the electrodes were heated at 400°C for 10 hours.

Electrochemical Impedance Spectroscopy (EIS) Testing

In the first phase of testing the 1.0mm supports (sputtered and non-sputtered), coated with the different metal oxides or left uncoated, were subjected to EIS testing in 250mL of a 0.01M NaClO₄ solution. In order to vary the arsenic (V) concentrations spike solutions were made using a Na₂HAsO₄•7H₂O salt (all solutions were brought to a pH of approximately 7 so that changes in the pH of the system should have negligible influence on the EIS curves). To perform the EIS testing a potentiostat (PAR VMP2) and 3-electrode configuration was utilized. The Working Electrode (WE) – the electrode of interest – was the support coated with the different metal oxides or left uncoated. The Counter Electrode (CE) was a piece of sanded 1.0mm titanium. Both the WE and CE had dimensions of ~1cm x ~6cm and extended approximately 33mm into solution and were separated by a distance of approximately 9-10mm. The third electrode is the reference electrode, a saturated calomel electrode (SCE), that was placed between the WE and CE. Figure 1, has been provided to give a visual of the setup.

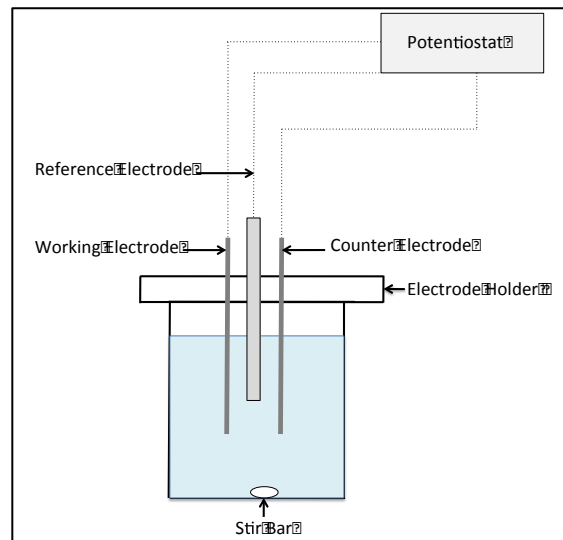

Figure 1. Setup used to perform the EIS testing (not to scale).

The following parameters were used to perform the EIS tests. The electrodes were allowed to equilibrate in the 0.01M NaClO₄ solutions overnight. The next day, the electrodes were submitted to the following sequence in the NaClO₄ solution: 20 min open circuit voltage (OCV) followed by Potentio Electrochemical Impedance Spectroscopy with the following parameters: E_{WE} = 0V vs. E_{oc} for 3min; Frequency range = 10 kHz to 0.05Hz; points per decade = 20; sinus amplitude = 20mV. This sequence (OCV then EIS) was repeated 3 more times (4x total = OCV, EIS, OCV, EIS, OCV, EIS, OCV, EIS). The 0.01M NaClO₄ solution was then spiked with arsenate to bring the arsenic concentration to 10⁻⁸M and the same sequence (OCV, EIS) was repeated 4x. The next day the OCV and EIS sequence was performed in triplicate starting with a repeat of the 10⁻⁸M arsenic concentration, followed by arsenic concentrations of 10⁻⁷, 10⁻⁶, 10⁻⁵ and finally 10⁻⁴M. Throughout the entire process the test solution was stirred with a magnetic stir bar.

Since the ZrO₂ coated electrode appeared to be one of the top performers from the above tests, new electrodes were fabricated utilizing a 0.5mm titanium support sputter coated with platinum and dipped 10x into the ZrO₂ sol (heated at 400°C for 30min between each coating) and submitted to EIS testing using 250mL of different electrolyte solutions. The new solutions tested were a 0.01M NaClO₄, 0.01M KClO₄, 0.005M Ca(ClO₄)₂, 0.005M Mg(ClO₄)₂, 0.01M NaCl, 0.01M NaNO₃, 0.005M Na₂SO₄ and a 0.005M Na₂CO₃ solution. All solutions were brought to a pH of 7 with HClO₄ or NaOH (meaning that the dominant species in the carbonate solution (0.005M Na₂CO₃) is HCO₃⁻). In addition, solutions brought to pHs of 3, 5, or 9 were also tested in some cases. The same EIS sequence described above was used for these tests with a few exceptions. The frequency range used was decreased to 10kHz to 1Hz. Since this smaller frequency range reduced the time of testing the entire sequence (0M, 10⁻⁸M, 10⁻⁷M, 10⁻⁶M, 10⁻⁵M, 10⁻⁴M) could be performed in triplicate in one day.

RESULTS AND DISCUSSION

Electrochemical Impedance Spectroscopy Background

In order to gain a greater understanding of the results presented in this section a brief introduction to Electrochemical Impedance Spectroscopy (EIS) is likely needed and provided below.

In Electrochemical Impedance Spectroscopy a perturbing potential (sinusoidal in this research) is applied to an electrode that in turn produces an alternating current wave that is shifted from that of the potential wave. This can be expressed with the following equation: $\bar{V} = \bar{I}Z$ where \bar{V} and \bar{I} are the time dependent potentials and currents and Z is the impedance (Monk, 2001). Alternatively, the overall impedance “Z” can be expressed in a complex format, with the equation: $Z = Z_r - jZ_i$ where Z_r and Z_i are the real and imaginary impedances and $j = \sqrt{-1}$. For a resistor having no capacitance, the resistance “R” will be equal to Z_r ; for a pure capacitor with no resistance, Z_i is related to the capacitance using equation: $Z_i = 1/(j\omega C)$, where C is the capacitance and ω is the frequency (radians per second) (Monk, 2001).

In this report the data displaying the influence of arsenic on the EIS curves is presented by plotting the phase angle versus frequency at different arsenic concentrations. The phase angle is related to the real and imaginary impedance through the equation: $\theta = \tan^{-1}(Z_i/Z_r)$, where $\theta =$

phase angle, and Z_i and Z_r are the imaginary and real impedances respectively (Barsoukov and Macdonald, 2005). Furthermore, to develop calibration curves for arsenic, the normalized phase angle was plotted versus the $-\log$ of the arsenic concentration. A similar method was used in the work of Rachel et al. (2011, 2013); in their work, they used EIS and phase angle data to develop calibration curves for phosphate concentrations. The normalized phase angles used in the research presented here were calculated using the average phase angle of the 10^{-8} M arsenic concentrations at a certain frequency as the normalizing term when the 1.0mm support was used; more precisely, the following equation was used: normalized phase angle = avg. phase angle 10^{-8} M As (at a specific frequency) – the phase angle at a given arsenic concentration (at the same frequency). For the 0.5mm supports the same formula was used, but instead of using the average phase angle of the 10^{-8} M arsenic concentration the average phase angle of the 0M arsenic concentration was used (the reason for this difference is that all the EIS tests for the 0.5mm support were performed on the same day (including the 0M) while tests utilizing the 1.0mm support were conducted over two days with the 0M being performed on the first day and the rest of the concentrations on the second).

Since each of the metal oxide xerogels has different physical-chemical properties (specific surface areas, porosities, zeta potentials) one would expect that they would behave differently in the presence of arsenate. For instance, arsenate has been shown to adsorb to a variety of metal oxide materials (Hristovski, 2007). Furthermore, the adsorption of arsenate to different metal oxides will likely alter the zeta potential of the material (Anderson and Malotky, 1979; Anderson et al, 1976). Moreover, Leonard et al. (2012) showed that as the metal oxides deviate from their isoelectric pH and the magnitude of the zeta potential increases, the capacitance of the material also increases (in their worked they showed the largest changes occur within 1 pH unit of the isoelectric pH). Thus, if the zeta potential of the metal oxides used in this project changes because of arsenate adsorption, a change in capacitance may also occur. Since capacitance is related to the imaginary impedance and the imaginary impedance is related to the phase angle through the equations stated above, one would expect that the adsorption of arsenate to the metal oxide should alter the phase angle and a calibration curve for arsenic can be developed.

Testing the Different Metal Oxide Coatings

Since 6 different sols were used to produce the coatings (acidic SiO_2 , basic SiO_2 , ZrO_2 , TiO_2 , AlOOH and Fe_2O_3), as well as different heating temperatures between coatings, number of coatings, supports (titanium vs. titanium sputtered with platinum) it is unrealistic to display all the data obtained during this phase of testing. Thus, only a brief generalization for each metal oxide's sensitivity to arsenic and problems encounters are mentioned below; with the exception of the ZrO_2 coating that will be examined further in the next paragraph and section.

- Acidic SiO_2 : Problems encountered with the reproducibility of the thin-film coatings (gelling occurred on some of the electrodes and not on others); when coated on the titanium support where no gelling of SiO_2 occurred the sensor had sensitivity to arsenic at high frequencies; however, before continuing with this metal oxide sol the coating inconsistencies have to be solved.
- Basic SiO_2 : Produced repeatable coatings (no gelling), but was less sensitive to arsenic than other metal oxides tested.

- Al_2O_3 : Had to be heated at 200°C between coatings in order to sinter the AlOOH particles to the support; sensitivity was not as good as other metal oxides tested.
- Fe_2O_3 : Had repeatability issues at constant concentrations of arsenic (phase angle drift) and the sensitivity was not as good as other metal oxides tested.
- TiO_2 : Very good sensitivity to arsenic at low frequencies when coated onto the titanium support sputter coated with platinum and heated at 400°C between coatings; however, the repeatability at a given concentration of arsenic was poor (drift); this would have to be solved before moving forward with this metal oxide.
- ZrO_2 : Had to be heated at 400°C between coatings to improve the wettability (when heated at 200°C the wettability was poor and little metal oxide deposition was observed); when the titanium support sputter coated with platinum was dipped 10x in the ZrO_2 (heated at 400°C for 30min between dips) it have very good sensitivity to arsenic at high frequencies (see Figure 2B and Figure 3).

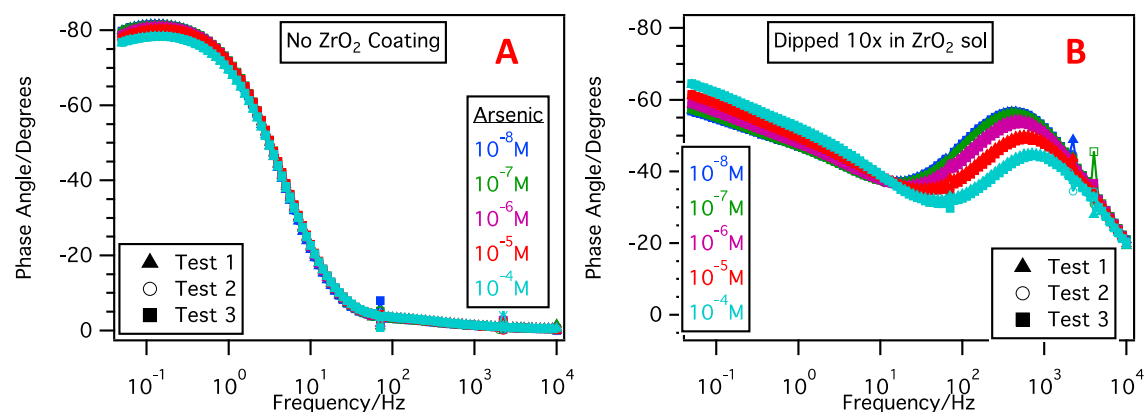

Figure 2. Phase angle vs. frequency curves in a 0.01M NaClO_4 solution ($\text{pH}=7$); A. 1.0 mm titanium support sputter coated with platinum; B. 1.0 mm titanium support sputter coated with platinum and dipped 10x in the ZrO_2 sol (heated at 400°C between coatings).

Of all the metal oxide coatings and parameters tested the titanium support sputter coated with platinum and dipped into the ZrO_2 sol appeared to be one of the most sensitive materials to arsenic. Figure 2 compares the phase angle versus frequency curves for the sputter coated titanium support (A) versus the same type of support, but coated 10x with ZrO_2 (B). In each of the figures the different colors represent different concentrations of arsenic and the shapes represent test numbers at the same concentration (each concentration was run in triplicate). As can be seen in the figure, the shapes of the curves and the separation of the curves between different concentrations of arsenic are very different (the electrode coated with ZrO_2 has much greater separation between arsenic concentrations). Shown in Figure 3 is a calibration curve for arsenic (performed at a frequency of 177.78Hz). As can be seen in Figure 3, the electrode appears to have sensitivity between the 10^{-7} and 10^{-6}M arsenic concentrations. Since this electrode appeared to have good separation between arsenic concentrations at higher frequencies, the coatings appeared repeatable and the standard deviations at a given concentration of arsenic were small, similar electrodes will be fabricated and subjected to tests with different ions present in solution to examine for interference with arsenic.

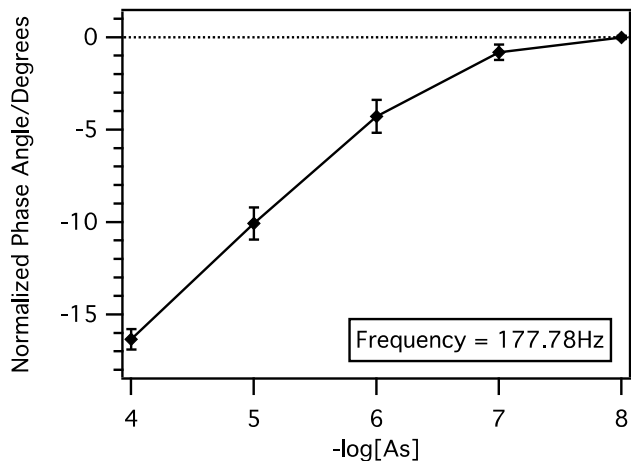

Figure 3. Arsenic calibration curve at a frequency of 177.78 Hz for a 1.0 mm titanium support sputter coated with platinum and dipped 10x in a ZrO₂ sol (heated at 400°C between coatings); same electrode as that shown in Figure 2.

Testing for Cation and Anion Interference with Arsenate

In this part of the project electrodes were fabricated using a 0.5mm titanium support sputter coated with platinum and coated 10x with ZrO₂ (heated at 400°C between coatings (30min)). The purpose of this analysis was to determine if cations or anions will cause any interference with the arsenic detection. In order to be consistent, Na⁺ was used as the common cation when different anions were tested and ClO₄⁻ as the common anion when different cations were tested. In addition, in each of the tests a new sensor electrode was used, unless otherwise noted. Moreover, the pH of the test solution and arsenate spike solutions were all at a pH of approximately 7 unless otherwise stated. Finally, the data for all calibration curves was acquired at a frequency of 355Hz (354.66Hz to be more precise).

The first series of tests shows the calibration curves for arsenic in either a 0.01M NaClO₄ or 0.01M KClO₄ solutions. As can be seen in Figure 4, the curves appear similar whether Na⁺ or K⁺ is the cation (ClO₄⁻ is the anion in both solutions). Moreover, both sets of curves have good separation between the different concentrations of arsenic (after the 10⁻⁸M concentration). This finding was somewhat expected as Na⁺ or K⁺ should both have limited specific adsorption to the ZrO₂ film.

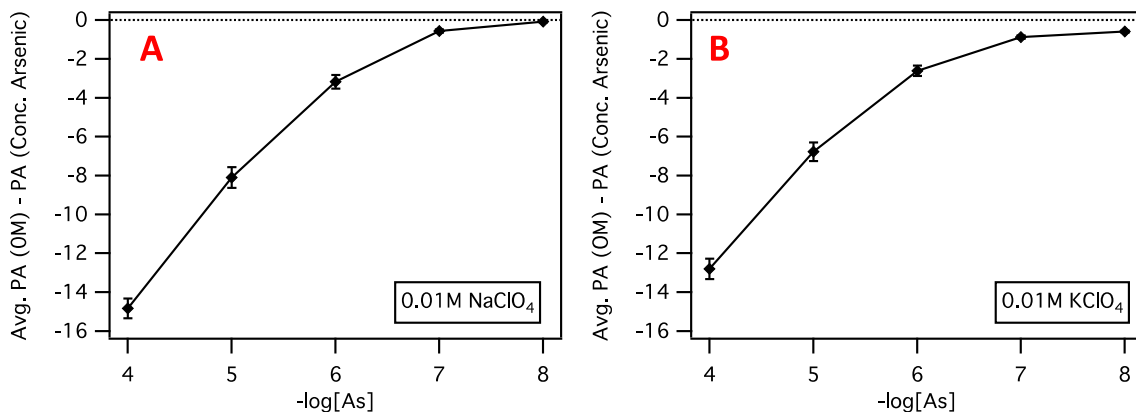

Figure 4. Calibration curves for different solutions spiked with arsenate at a frequency = 355 Hz; A. 0.01M NaClO₄; B. 0.01M KClO₄; all solutions pH=7.

The next series of tests examines interference with multivalent cations; specifically, Ca^{2+} or Mg^{2+} - common cations found in hard water. These tests were performed in either 0.005M $\text{Ca}(\text{ClO}_4)_2$ or 0.005M $\text{Mg}(\text{ClO}_4)_2$ solutions (at pH=7) that were spiked with arsenate. As can be seen in Figure 5, the calibration curves for arsenic are much less sensitive when Ca^{2+} (5A - black triangles) or Mg^{2+} (5B - black triangles) is used as the electrolyte than Na^+ or K^+ (Figure 4). Tests at different pHs (5, 3, 9 in this order) were also performed using the same electrodes (not shown) to see if there would be any improvement with sensitivity, but no improvement was observed.

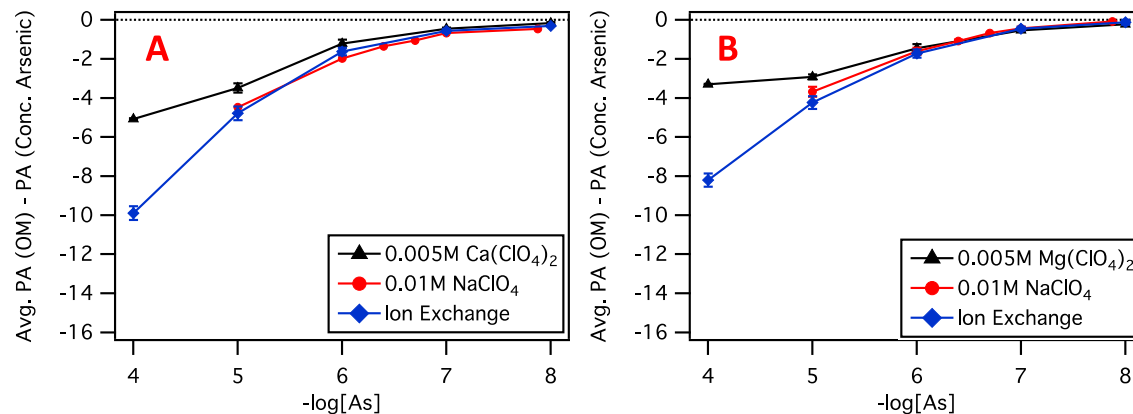

Figure 5. Calibration curves for different solutions spiked with arsenate at a frequency = 355Hz; A. 0.005M $\text{Ca}(\text{ClO}_4)_2 \rightarrow 0.01\text{M NaClO}_4 \rightarrow \text{Ion Exchange}$ solution; B. 0.005M $\text{Mg}(\text{ClO}_4)_2 \rightarrow 0.01\text{M NaClO}_4 \rightarrow \text{Ion Exchange}$ solution; the arrows represent the test order; all at pH=7.

Since, previous tests displayed that the sensor electrodes performed well in a NaClO_4 solution (Figure 4A), the $\text{Ca}(\text{ClO}_4)_2$ and $\text{Mg}(\text{ClO}_4)_2$ were passed through a water softening resin filter cartridge (PENTEK WS-20) to exchange the Ca^{2+} or Mg^{2+} for Na^+ (a similar procedure could likely be performed in the field). Before testing the sensor with the solutions passed through the ion exchange resin, it was first tested in a NaClO_4 solution (red circles in Figures 5A and 5B). As can be seen in the figure, there does appear to be improvements when the same sensors tested in the calcium or magnesium solutions were then tested in the NaClO_4 solutions, but not to the same extent as that shown in Figure 4A. Since these sensors were used in previous tests one plausible explanation for this finding may be due to difficulties encountered removing previously adsorbed species such as, Ca^{2+} , Mg^{2+} or arsenate from the ZrO_2 coating. It should be noted that after repeated testing in a NaClO_4 solution, electrodes also displayed a decrease in sensitivity to arsenic. Nevertheless, after the tests were performed in the NaClO_4 solution the same sensor electrodes were tested in the calcium or magnesium solutions passed through the ion exchange resin (blue diamonds). As expected, the results from the solutions passed through the ion exchange resin were similar to the previous tests performed in the 0.01M NaClO_4 solutions. A couple of things to note: First, it is likely that new electrodes tested with the $\text{Ca}(\text{ClO}_4)_2$ or $\text{Mg}(\text{ClO}_4)_2$ solutions passed through the ion exchange resin would likely produce results similar to those shown in Figure 4A (no adsorption of species from previous tests decreasing performance). It is also worth mentioning that when a 0.005M calcium or magnesium perchlorate solution (with arsenate) was run through the water softening resin filter cartridge the

concentration of Ca^{2+} or Mg^{2+} was reduced to undetectable levels; while the arsenate concentration had little change (all measured by ICP-OES) – meaning there was no adsorption of arsenate to the cartridge, thus this could be used as an exchange technique without interfering with the concentration of arsenate.

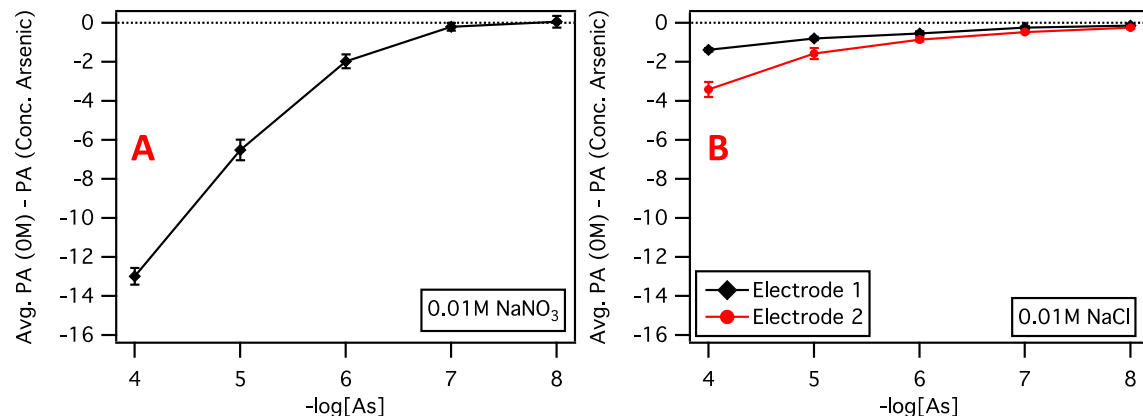

Figure 6. Calibration curves for different solutions spiked with arsenate at a frequency = 355 Hz; A. 0.01M NaNO₃; B. 0.01M NaCl; in 5B two new electrodes were tested; pH=7.

The next ions examined were monovalent anions of ClO_4^- , NO_3^- and Cl^- . To perform these tests the following solutions: 0.01M NaClO_4 , 0.01M NaNO_3 or 0.01M NaCl were spiked with arsenate. The results obtained from the ClO_4^- tests have already been shown in Figure 4. The results of the NO_3^- and Cl^- tests are shown in Figure 6. As can be seen in Figure 6A, the calibration curve for arsenic in a 0.01M NaNO_3 solution is similar to that shown in Figure 4A for a NaClO_4 solution. On the other hand, when the sensor was tested in a NaCl solution the sensitivity appeared to decrease (Figure 6B – black diamonds). A second test was performed with a new electrode and on a different channel of the potentiostat (red circles in Figure 6B) to verify the NaCl results. While this produced a slightly greater response, it was still much smaller than that associated with the NaClO_4 solutions. The reason or mechanism for this finding is still under investigation; however, zeta potential measurements of ZrO_2 particles in a 0.01M NaCl solution were more negative than in a 0.01M NaClO_4 solution and the isoelectric pH shifted to lower pH values in the NaCl solution – meaning that at a concentration of 0.01M the ClO_4^- and Cl^- ions may be interacting with the ZrO_2 film differently and this may be affecting the impedance data.

The last systems examined were those containing anions of either SO_4^{2-} or carbonate species. The solutions tested were a 0.005M Na_2SO_4 and a 0.005M Na_2CO_3 solution. As can be seen in Figure 7A, the presence of 0.005M SO_4^{2-} appears to reduce the sensitivity of the electrode compared to solutions containing either NO_3^- or ClO_4^- species. The carbonate system is shown in Figure 7B. In order to perform this test the 0.005M Na_2CO_3 solution was prepared and brought to a pH = 7 (Test 1 – black triangles in Figure 7B). At a pH of 7 the predominant species of carbonate will be HCO_3^- (and to a lesser extent H_2CO_3); while the dominant species of arsenate should be H_2AsO_4^- and HAsO_4^{2-} . As can be seen in the Figure 7B, at a pH=7 the sensor has very little sensitivity to arsenic. In order to try to alleviate this problem a second test was performed at pH=5 (red diamonds in Figure 7B). At a pH of 5 the H_2CO_3 will be the dominant carbonate species (and the HCO_3^- to a lesser extent); while the H_2AsO_4^- will be the dominant arsenate

species (notice the dominant carbonate species is not charged, but the arsenate species is). The results of this experiment are the red diamonds in Figure 7B. While lowering the pH to 5 improved the sensitivity it did not improve it to the levels found with the NaClO_4 or NaNO_3 solutions at $\text{pH}=7$. In addition, tests where the carbonate solution's pH was brought to 3 or 9 were also tested, but they had less sensitivity than the test run at $\text{pH}=5$. Furthermore, a test where the carbonate system's pH was dropped to 3 and then flushed with nitrogen using a diffuser to remove the CO_2 and brought back up to $\text{pH}=7$ (this was done an effort to remove the carbonate from the system) was also tested. While this technique did improve the sensitivity over the other $\text{pH}=7$ test (with no nitrogen flush) when the arsenic concentrations was equal to 10^{-4}M , it did not have the same level of sensitivity as the $\text{pH}=5$ system.

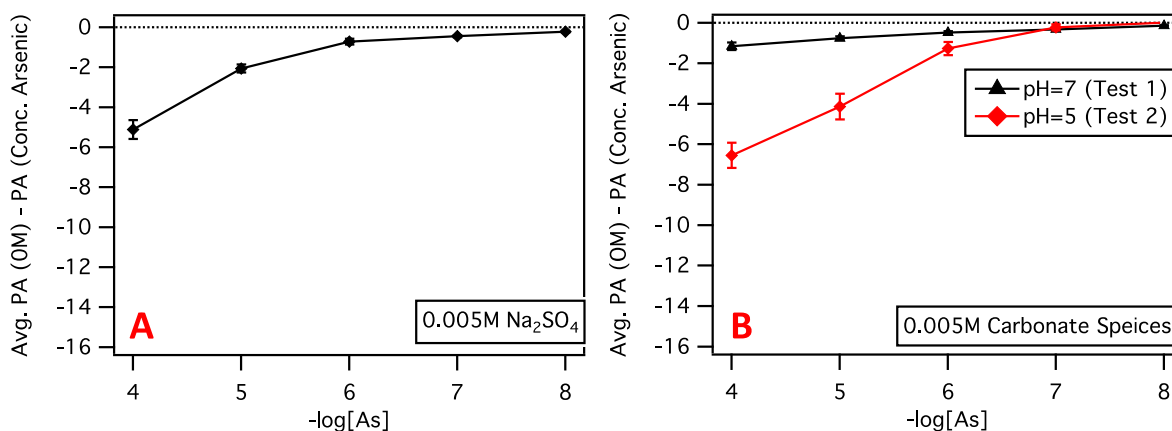

Figure 7. Calibration curves for different solutions spiked with arsenate at a frequency = 355 Hz; A. 0.005M Na_2SO_4 ($\text{pH}=7$); B. 0.005M Na_2CO_3 solution brought to a $\text{pH}=7$ (Test 1) and $\text{pH}=5$ (Test 2).

CONCLUSIONS AND RECOMMENDATIONS

Conclusions

Based off the work performed in this research project, it was found that using electrochemical impedance spectroscopy and sensor electrodes that employ nanoporous metal oxide thin-films shows promise as a new technique for detecting arsenic. Furthermore, the metal oxide used to produce the coatings, heating temperatures during coating, the amount of metal oxide deposited on the support and the support itself all play a role in the performance of sensor. Of all the metal oxide coatings tested, the titanium support (sputtered with platinum) coated 10x with ZrO_2 (heated at 400°C between coatings) appeared to be one of the most promising composites for the detection of arsenic using electrochemical impedance spectroscopy. It had good sensitivity to different arsenic concentrations, the sensitivity occurred at high frequencies and the fabrication process associated with the electrode appeared repeatable.

When the ZrO_2 coated electrode was submitted to testing in solutions with different ions present it had good arsenic detection in some solutions (NaClO_4 , KClO_4 , NaNO_3), but not others. For solutions containing Ca^{2+} or Mg^{2+} this sensor material benefits if the solutions are run through a water softening resin before testing to exchange the divalent cations for sodium. For anions such as Cl^- , SO_4^{2-} and CO_3^{2-} additional effort has to be dedicated to improving the arsenic sensor's

detection limits when these anions are present. This may involve some sort of separation technique (removing the problematic species from solution before performing the EIS tests to establish the arsenic calibration curve), adjusting of the pH (as shown with the carbonate system), testing other coatings with these ions to see if there is less interference with arsenic when a different coating is tested.

Future Work

Listed below are areas that should be further investigated for the sensor technology presented here to move forward:

- Testing the use of other metal oxide coatings for the sensor materials in the presence of interfering ions – these may be coatings that did not perform as well in the NaClO₄ solution as the ZrO₂ coating, but may have less interference between arsenic and other ions in solution.
- Performing repeatability testing of the sensor material (after repeated arsenate exposure, exposure to different electrolyte solutions and amongst new electrodes produced in the fabrication process).
- Test the influence of other ions not studied in this project and the potential for the sensor to detect species other than arsenate in water (e.g. - phosphorous species, arsenite).
- Examining the use of other frequencies in the impedance spectrum to develop calibration curves that may have less interference.
- With the knowledge gained through the above studies, test real water solutions with arsenic to determine the viability of the sensor.

REFERENCES

- Anderson, M. A.; Ferguson, J. F.; Gavis, J., Arsenate adsorption on amorphous aluminum hydroxide. *Journal of Colloid and Interface Science* **1976**, *54* (3), 391-399.
- Anderson, M. A.; Malotky, D. T., The adsorption of protolyzable anions on hydrous oxides at the isoelectric pH. *Journal of Colloid and Interface Science* **1979**, *72* (3), 413-427.
- Barsoukov, E.; Macdonald, J. R., *Impedance spectroscopy: theory, experiment, and applications*. **2005**. John Wiley & Sons.
- Chu, L.; TejedorTejedor, M. I.; Anderson, M. A., Particulate sol-gel route for microporous silica gels. *Microporous Mater.* 1997, *8* (5-6), 207-213.
- Hristovski, K.; Baumgardner, A.; Westerhoff, P., Selecting metal oxide nanomaterials for arsenic removal in fixed bed columns: from nanopowders to aggregated nanoparticle media. *Journal of Hazardous Materials* **2007**, *147* (1), 265-274.
- Leonard, K. C.; Suyama, W. E.; Anderson, M. A., Evaluating the Electrochemical Capacitance of Surface-Charged Nanoparticle Oxide Coatings. *Langmuir* **2012**, *28*, (15), 6476-6484.
- Monk, P., *Fundamentals of electroanalytical chemistry*. **2001**. England: John Wiley & Sons Ltd.

Moss, R. E.; Jackowski, J. J.; de Souza Castilho, M.; Anderson, M. A., Development and evaluation of a nanoporous iron (hydr) oxide electrode for phosphate sensing. *Electroanalysis* **2011**, *23* (7), 1718-1725.

Moss, R. E.; Pérez-Roa, R. E.; Anderson, M. A., Electrochemical response of titania, zirconia, and alumina electrodes to phosphate adsorption. *Electrochimica Acta* **2013**, *104*, 314-321.

Moss, R. E.; Pérez-Roa, R. E.; Anderson, M. A., Effects of pH on phosphate adsorption to hematite as studied with cyclic voltammetry and electrochemical impedance spectroscopy. *Journal of The Electrochemical Society* **2013**, *160* (2), H105-H112.

Wouters, J. J.; Lado, J. J.; Tejedor-Tejedor, M. I.; Anderson, M. A., Low Surface Area Carbon Fiber Electrodes Coated with Nanoporous Thin-Films of Al₂O₃ and SiO₂: Relationship between Coating Conditions, Microstructure and Double Layer Capacitance. *Journal of The Electrochemical Society* **2012**, *159* (8), A1374-A1382.

Xu, Q.; Anderson, M. A., Synthesis of porosity controlled ceramic membranes. *Journal of materials research* **1991**, *6* (05), 1073-1081.

APPENDIX A

Future Publications (In Progress)

Three manuscripts describing the work performed in this project are currently in preparation. The following are tentative titles for the articles, followed by a brief description of what each article will focus on.

1. “Examining the Performance of SiO₂, ZrO₂, TiO₂, Al₂O₃ or Fe₂O₃ Coatings for Arsenic Detection Utilizing Electrochemical Impedance Spectroscopy” (This paper will focus on the electrochemical detection of arsenic with the different coatings).
2. “Electrochemical Impedance Spectroscopy Response of a ZrO₂ Coated Electrode to Changes in Arsenic Concentrations” (This paper will examine the interaction of arsenic with the ZrO₂ thin-film - mechanistic approach that will likely include modeling of the system).
3. “Electrochemical Detection of Arsenic Using a ZrO₂ Coated Electrode and Impedance Spectroscopy: Examining the Influence of Ion Competition, pH, Number of Coatings and Electrode Size” (This paper will concentrate on the detection of arsenic and different variables that may influence its detection capabilities).

Patents

An invention disclosure has been submitted to the Wisconsin Alumni Research Foundation.

Impact of Work

The work described here involves the development of a sensor technology to measure arsenic concentrations. This research could have an impact on a variety of fields. From scientist or researchers that are trying to develop new environmental sensors to personnel working/studying/protecting our groundwater or surface waters and looking for techniques to quickly and accurately obtain environmental measurements.